

Australia's Leading Supplier of Medical & Surgical Instruments



OZZE MEDICAL & SURGICAL SUPPLIES

TOOLS TO OPERATE

**SURGICAL
INSTRUMENTS
CATALOGUE**

**TGA
Approved
Instruments**

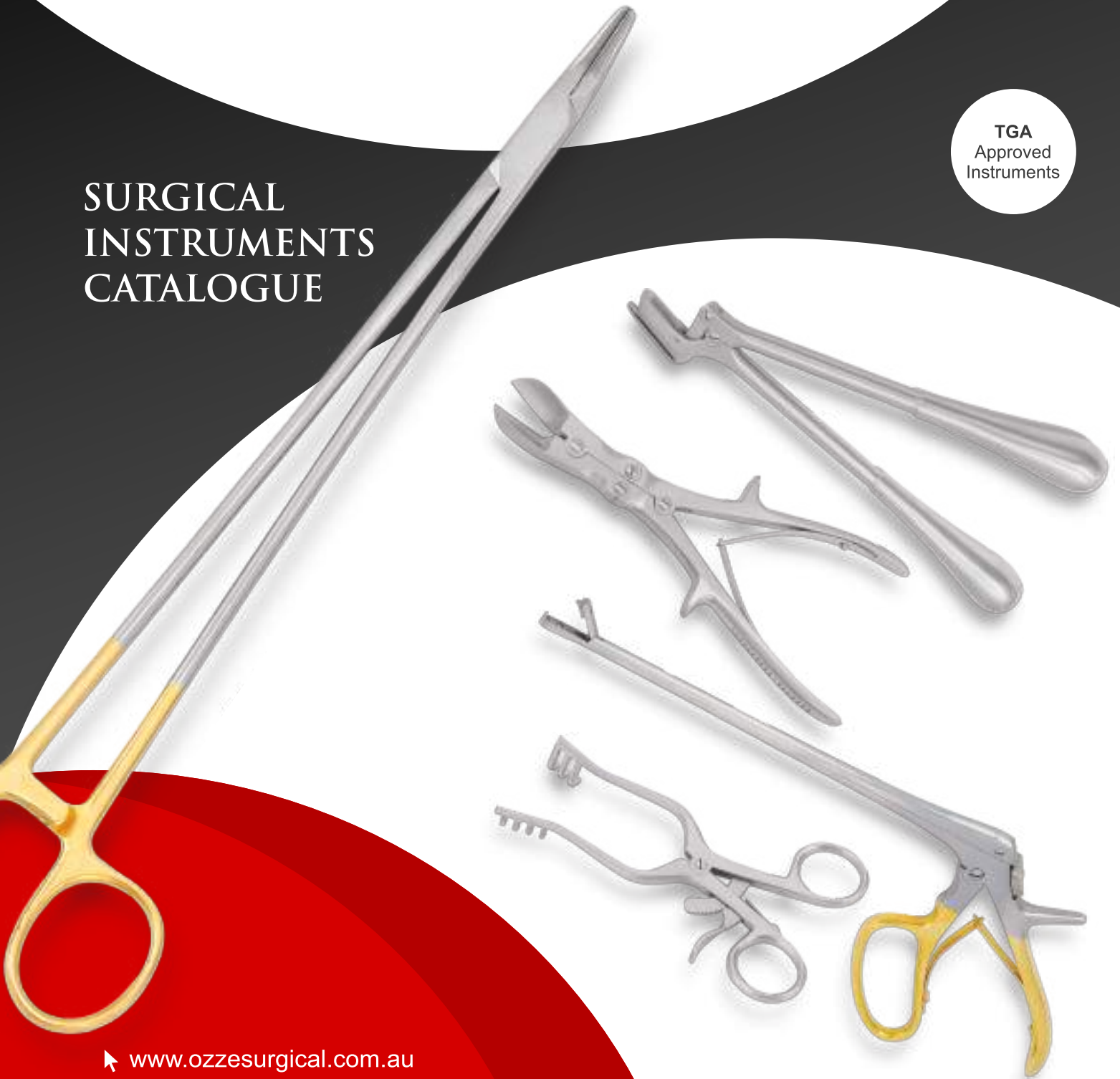

🖱 www.ozzesurgical.com.au
✉ info@ozzesurgical.com.au

Company Profile

Ozze Surgical is Australia's leading Supplier of Medical, Dental and Surgical Instruments. It originally founded in 2007, with its high-quality instruments – but we don't rest on our laurels. Ozze Surgical continues to evolve its offerings in high-quality and innovative surgical solutions including some of the famous brands. Our extensive Instrument portfolio provides the breadth and depth across all surgical specialties. With a wide range of instruments available.

While headquartered in Hobart Australia, we have a global reach and operate new product development, manufacturing, distribution and sourcing facilities in Australia, Germany, US, China, Pakistan and India. Our engineers sitting in these countries whom we collaborate with, in order to get the finest products in hand.

At Ozze Surgical®, we maintain a rich legacy of trusted brands, quality, innovation, and customer service which is supporting all surgical specialties and sites of care. In surgery, we know what is at stake, and that is why our products are built with craftsmanship, innovation and attention to detail. We create products and solutions so healthcare professionals can trust to consistently and perform to the highest of standards.

We use pure German grade stainless steel and other raw materials to manufacture our top quality instruments and we are proud that our customers and their patients trust us to provide them with high quality surgical instruments while scrupulously adhering to the laws and regulations that govern our industry and business.

We have adopted all the essential code of ethics to ensure that we engage with healthcare professionals in a fully compliant and ethical manner. This Code is part of our effective, ongoing compliance program.

At Ozze Surgical®, the most important factor is innovation which is at the core of everything we do. We regularly collaborate with caregivers to develop and commercialize ideas that have a meaningful impact on patient care. Many of Ozze Surgical's product innovations have come directly from practicing clinicians. We collaborate with our customers to identify and solve problems they face in clinical practice. We pride ourselves on bringing the best solution forward. So please give us a chance to prove and fulfil our commitments we made to you. We are happy to provide some free samples of our innovative and modern instruments.

Dear customer send us an email or speak to us directly, regarding your free samples today. We do make customise Surgical and dental instruments or any other medical device if you have in your mind.

Thank You Reading Our Profile Ozze Surgical Australia

Ozze Surgical Australia

Our Mission

Make impossible to possible by Elevating Surgery for life

Our Visions

Our collaborative initiative and efforts will help to save more lives on the planet. Ozze Surgical is confident to play an important role in every Surgical Procedure Worldwide to increase the life saving possibilities.

Our Values / Trust

The important beginning and Foundation of Every Interaction.

Passion

We have the motivation to Win

Excellence

An extra ordinary Approach to do everything, because teamwork excellency is impossible without teamwork.

Innovation

Changing the medical world with new innovative ways.



Table Of Contents

Scheren Scissors

Oberflächenbeschreibung	Surface Description	SC 1 - SC 4
Mikro - Federscheren	<i>Micro Spring Scissors</i>	SC 5 - 16
Feine Scheren	<i>Delicate Scissors</i>	SC 17 - 23
Feine chirurgische Scheren	<i>Delicate Surgical Scissors</i>	SC 24 - 26
Chirurgische Scheren	<i>Surgical Scissors</i>	SC 27 - 31
Feine Präparierscheren	<i>Delicate Dissecting Scissors</i>	SC 32 - 37
Enukleationsscheren	<i>Enucleation Scissors</i>	SC 38
Präparierscheren	<i>Dissecting Scissors</i>	SC 39 - 51, 54 - 63
Facelift- und Nasenscheren	<i>Facelift and Nasal Scissors</i>	SC 52 - 53
Nasenscheren	<i>Nasal Scissors</i>	SC 64 - 67
Gefäßscheren	<i>Vascular Scissors</i>	SC 68 - 75
Neurochirurgische Scheren	<i>Neurosurgical Scissors</i>	SC 76 - 77
Tonsillen-Scheren	<i>Tonsil Scissors</i>	SC 78 - 79
Darmscheren	<i>Enterotomy Scissors</i>	SC 80
Ligaturscheren	<i>Ligature Scissors</i>	SC 81 - 82
Gynäkologische Scheren	<i>Gynecological Scissors</i>	SC 83 - 86
Nabelschnurscheren	<i>Umbilical Scissors</i>	SC 87
Damm-(Episiotomie-)Scheren	<i>Perineum (Episiotomy) Scissors</i>	SC 88
Parametriumscheren	<i>Parametrium Scissors</i>	SC 89
Kronenscheren	<i>Crown Scissors</i>	SC 90
Zahnfleischscheren	<i>Gum Scissors</i>	SC 91 - 92
Nagelscheren	<i>Nail Scissors</i>	SC 93
Draht-, Blechscheren	<i>Wire, Metal Cutting Scissors</i>	SC 94
Verbandscheren	<i>Bandage Scissors</i>	SC 95 - 101
Gipsscheren	<i>Plaster Shears</i>	SC 102
Knochenscheren	<i>Bone Scissors</i>	SC 103
Rippenscheren	<i>Rib Shears</i>	SC 104

Skalpelle und Messer Scalpels and Knives

Skalpelle	Scalpels	SK 1 - 4
Rasierklingen, Rasierklingenbrecher und -halter	<i>Razor Blades, Razor Blade Breaker and -Holder</i>	SK 5 - 6
Anatomische Skalpelle	<i>Dissecting Knives</i>	SK 7
Amputationsmesser	<i>Amputation Knives</i>	SK 8
Resektions- und Seziermesser	<i>Resection- and Autopsy Knives</i>	SK 9
Dermatome	<i>Dermatomes</i>	SK 10

Table Of Contents

Pinzetten Forceps

Mikro-Uhrmacher Pinzetten	<i>Micro Jewelers Forceps</i>	FC 1
Mikro-Nahtpinzetten	<i>Micro Suture Forceps</i>	FC 2 - 3
Anatomische Mikro-Pinzetten	<i>Dissecting Micro Forceps</i>	FC 4 - 7
Mikro-Tumorfaßpinzetten	<i>Micro Tumor Grasping Forceps</i>	FC 8 - 9
Mikro-Pinzetten, Rundgriff	<i>Micro Forceps, Round Handle</i>	FC 10
Feine anatomische Pinzetten	<i>Delicate Dissecting Forceps</i>	FC 11 - 18
Anatomische Pinzetten	<i>Dissecting Forceps</i>	FC 19 - 21
Atraumatische Pinzetten	<i>Atraumatic Forceps</i>	FC 22
Ohrpinzetten	<i>Ear Dressing Forceps</i>	FC 23 - 24
Feine chirurgische Pinzetten	<i>Delicate Tissue Forceps</i>	FC 25 - 32
Chirurgische Pinzetten	<i>Tissue Forceps</i>	FC 33 - 36
Hautpinzetten	<i>Skin Forceps</i>	FC 37
Darm- und Lungenpinzetten	<i>Intestinal and Lung Forceps</i>	FC 38
Fasspinzetten	<i>Grasping Forceps</i>	FC 39
Splitterpinzetten	<i>Splinter Forceps</i>	FC 40
Splitterzangen	<i>Splinter Forceps</i>	FC 41
Cilienpinzetten	<i>Cilia Forceps</i>	FC 42

Klemmen und Zangen Clamps and Forceps

Arterienklemmen	<i>Hemostatic forceps</i>	CF 1 - 25
Ligaturklemmen	<i>Ligature Forceps</i>	CF 26 - 39
Klemmzangen	<i>Clamp Forceps</i>	CF 40 - 41
Peritoneumklemmen	<i>Peritoneal Forceps</i>	CF 42 - 44
Tuchklemmen	<i>Towel Forceps</i>	CF 45 - 48
Schlauchklemmen	<i>Tubing Forceps</i>	CF 49 - 50
Kornzangen	<i>Dressing Forceps</i>	CF 51 - 53
Tupferzangen	<i>Cotton Swab Forceps</i>	CF 54 - 55
Schwammzangen	<i>Sponge Holding Forceps</i>	CF 56 - 57
Bulldogklemmen	<i>Bulldog Clamps</i>	CF 58 - 61

Table Of Contents

Retraktoren Retractors

Feine Wundhäkchen	<i>Fine Wound Retractors</i>	RE 1 - 2
Wund- und Trachealhäkchen	<i>Wound and Trachea Retractors</i>	RE 3 - 6
Wundhaken	<i>Retractors</i>	RE 7 - 29
Spatel	<i>Spatulas</i>	RE 30
Wundspreizer	<i>Self-retaining Retractors</i>	RE 31 - 47, RE 49
Spezialwundspreizer	<i>Special Retractors</i>	RE 48
Bauchdeckenhalter	<i>Abdominal Retractors</i>	RE 50 - 64

Trokare, Saug- und Spülinstrumente, Sonden, Watteträger

Trocars, Suction and Irrigation Instruments, Probes, Cotton Applicators

Trokare	<i>Trocars</i>	TS 1 - 2
Kanülen	<i>Cannulas</i>	TS 3 - 7
Saug-Raspatorien, Saug-Dissektoren	<i>Suction Raspatories, Suction Dissectors</i>	TS 8
Mikro-Saugkanülen	<i>Micro Suction Tubes</i>	TS 9
Katheterzangen	<i>Catheter Forceps</i>	TS 10
Spritzen	<i>Syringes</i>	TS 11
Luer-Lock Adapter	<i>Luer-Lock Adapter</i>	TS 12
Führungsnadeln	<i>Guide Needles</i>	TS 13
Sonden	<i>Probes</i>	TS 14 - 17
Watteträger	<i>Cotton Applicators</i>	TS 18 - 20

Wundverschluß Woundclosure

Nadelhalter-Profil	<i>Needle Holder Tread</i>	WO 1 - 2
Mikro-Nadelhalter	<i>Micro Needle Holders</i>	WO 3 - 9
Nadelhalter	<i>Needle Holders</i>	WO 10 - 37
Unterbindungsnadeln	<i>Ligature Needles</i>	WO 38 - 43
Reverdinnadeln	<i>Reverdin Needles</i>	WO 44 - 45
Führungs-Hohlsonden	<i>Guiding Probes</i>	WO 46 - 50
Wundklammern	<i>Suture Clips</i>	WO 51
Klammeranlegepinzetten	<i>Clip Applying Forceps</i>	WO 52
Chirurgisches Taschenbesteck	<i>Pocket Instrument Set</i>	WO 53
Venae Sectio Besteck	<i>Venae Secito Set</i>	WO 54
Gipsverband- Instrumente	<i>Plaster Cast Instruments</i>	WO 55 - 58

Table Of Contents

Abdominale Chirurgie Abdominal Surgery

Darm- und Gewebefasszangen	<i>Intestinal and Tissue Grasping Forceps</i>	AS 1 - 6
Darmklemmen	<i>Intestinal Clamps</i>	AS 7 - 13
Magenklemmen	<i>Stomach Clamps</i>	AS 14
Magen- und Darmquetschklemmen	<i>Intestinal and Pylorus Clamps</i>	AS 15
Magen- und Darm-Zwillingsklemmen	<i>Stomach and Intestinal Twin Clamps</i>	AS 16
Anastomosenklemmen	<i>Anastomosis Clamps</i>	AS 17
Rektum-Anastomosenklemmen	<i>Sigmoid Anastomosis Clamps</i>	AS 18 - 19
Rektum-Spekula	<i>Rectal Specula</i>	AS 20 - 21
Rektoskope	<i>Rectoscopes</i>	AS 22 - 23
Analspreizer	<i>Rectal Spreader</i>	AS 24
Rektum-Biopsiefasszange	<i>Rectal Biopsy Forceps</i>	AS 25
Hämorrhoidalzangen	<i>Haemorrhoidal Forceps</i>	AS 26 - 27
Hämorrhoidal-Ligatoren	<i>Haemorrhoidal Ligators</i>	AS 28 - 30
Gallenkanal-Klemmzangen	<i>Gall Duct Forceps</i>	AS 31 - 32
Gallenkanal Instrumente	<i>Gall Duct Instruments</i>	AS 33 - 34
Nierenklemmen	<i>Kidney Clamps</i>	AS 35
Nierensteinzangen	<i>Kidney Stone Forceps</i>	AS 36
Blasenwundspreizer	<i>Bladder Retractors</i>	AS 37 - 38
Urologie-Instrumente	<i>Urology Instruments</i>	AS 39 - 43

Table Of Contents

Gynäkologie und Geburtshilfe Gynecology and Obstetrics

Scheidenspekula	<i>Vaginal Specula</i>	GO 1 - 18, 20 - 21
Scheidenhalter	<i>Vaginal Retractors</i>	GO 19
Uterusdilatoren	<i>Uterine Dilators</i>	GO 22
Endospekula für Cervix	<i>Endospecula for Cervix</i>	GO 23
Uterussonden	<i>Uterine Probes</i>	GO 24
Fasszangen	<i>Grasping Forceps</i>	GO 25
Hakenzangen	<i>Uterine Tenaculum Forceps</i>	GO 26 - 32
Polypen- und Ovarienzangen	<i>Polypus- and Ovary Forceps</i>	GO 33 - 34
Uterusfasszangen	<i>Uterine Elevating Forceps</i>	GO 36 - 37
Biopsieinstrumente	<i>Biopsy Instruments</i>	GO 37, 44
Parametriumklemmen	<i>Parametrium Forceps</i>	GO 38 - 40
Hysterektomieklemmen	<i>Hysterectomy Forceps</i>	GO 41 - 42
Vaginalklemmen	<i>Vaginal Forceps</i>	GO 43
Biopsie Küretten	<i>Biopsy Curettes</i>	GO 45
Biopsie Zangen	<i>Biopsy Forceps</i>	GO 46 - 51
Uterus Biopsie Zangen	<i>Uterine Biopsy Forceps</i>	GO 52 - 56
Uteruslöffel	<i>Uterine Scoops</i>	GO 54
Uterusküretten	<i>Uterine Curettes</i>	GO 55 - 57
Biopsie- und Absaugküretten	<i>Biopsy and Aspirating Curettes</i>	GO 58
Salpingograph	<i>Salpingograph</i>	GO 59 - 60
Geburtshilfe	<i>Obstetrics</i>	GO 61 - 62
Geburtszangen	<i>Obstetrical Forceps</i>	GO 63 - 65
Abortuszangen	<i>Ovum Forceps</i>	GO 66
Abortus- und Plazentazangen	<i>Ovum and Placenta Forceps</i>	GO 67
Uterusklemmzangen	<i>Uterine Forceps</i>	GO 68

Table Of Contents

Knochenchirurgie Bone Surgery

Meißel und Osteotome	<i>Chisels and Osteotomes</i>	BS 1 - 8
Scharfe Löffel	<i>Bone Curettes</i>	BS 9 - 15
Knochenraspel	<i>Bone Rasps</i>	BS 16
Rasparatorien	<i>Raspatories</i>	BS 17 - 24
Rasparatorien und Elevatorien	<i>Raspatories and Elevators</i>	BS 25
Elevatorien	<i>Elevators</i>	BS 26 - 27
Knochenhebel	<i>Bone Levers</i>	BS 28 - 31
Knochenhaken	<i>Bone Retractors</i>	BS 32 - 34
Spinalhaken, Meniskusmesser	<i>Spinal Retractors, Meniscus Knives</i>	BS 35
Knochenhaltezangen	<i>Bone Holding Forceps</i>	BS 36 - 44
Hohlmeißelzangen	<i>Bone Rongeurs</i>	BS 45 - 56
Knochensplitterzangen	<i>Bone Cutting Forceps</i>	BS 57 - 59
Instrumente für Fingernägel	<i>Nail Instruments</i>	BS 60
Sägen und Sägeblätter	<i>Saws and Saw Blades</i>	BS 61 - 62
Bohrapparate	<i>Hand Drills</i>	BS 63 - 65
Reibahlen	<i>Reamers</i>	BS 66
Bohrdrähte, Steinmann-Nägel	<i>Drill Wires, Steinmann Pins</i>	BS 67 - 69
Drahtspannzangen	<i>Wire Twisting Forceps</i>	BS 70 - 71
Drahtfasszangen	<i>Wire Holding Forceps</i>	BS 72
Flachzangen	<i>Flat Nose Pliers</i>	BS 73
Drahtschneidezangen	<i>Wire Cutting Pliers</i>	BS 74 - 76
Extensionsbügel	<i>Extension Bows</i>	BS 77
Cerclage-Instrumente	<i>Cerclage Instruments</i>	BS 78
Hämmer	<i>Mallets</i>	BS 79 - 84
Sehneninstrumente, Bleihand	<i>Tendon Instruments, Lead hand</i>	BS 85 - 87

Table Of Contents

HF-Chirurgie

HF-Surgery

HF-Handgriffe	<i>HF-Handles</i>	HF 1 - 2
Monopolare Elektroden	<i>Monopolar Electrodes</i>	HF 3 - 4
Bipolare Scheren	<i>Bipolar Scissors</i>	HF 5 - 6
Bipolare Pinzetten	<i>Bipolar Forceps</i>	HF 7 - 17
Bipolare Anschlusskabel	<i>Bipolar Connecting Cables</i>	HF 18

Hygiene und Aufbewahrung

Hygiene and Storage

Sterilisierzangen	<i>Sterilization Forceps</i>	HS 1
Dreieckschalen und Stechbecken	<i>Triangular Bowls and Bed Pans</i>	HS 2
Messbecher und Nierenschalen	<i>Measuring Jugs and Kidney Bowls</i>	HS 3
Behälter, rund	<i>Bowls, Round</i>	HS 4 - 6
Instrumentenschalen	<i>Instrument Trays</i>	HS 7 - 8
Siebkörbe, Größe 1/2	<i>Baskets, Half Size</i>	HS 9
Siebkörbe, Größe 3/4	<i>Baskets, Three-Quarter Size</i>	HS 10
Siebkörbe, Größe 1/1	<i>Baskets, Full Size</i>	HS 11
Siebkörbe, Größe Mini	<i>Baskets, Mini Size</i>	HS 12 - 13
Zubehör	<i>Accessories</i>	HS 14 - 15
Bereitstellungstische, Regalwagen	<i>Trolleys</i>	HS 16 - 17

Chirurgische Schmieden

Surgical Forgings

Knochenklammern	<i>Bone Clamps</i>	SF 1
Knochenklammern	<i>Bone Clamps</i>	SF 2
Knochen Skids	<i>Bone Skids</i>	SF 3
Chirurgische Kompressoren	<i>Surgical Compressors</i>	SF 4
Chirurgische Küretten	<i>Surgical Curettes</i>	SF 5
Chirurgische Distraktoren	<i>Surgical Distractors</i>	SF 6
Chirurgische Aufzüge	<i>Surgical Elevators</i>	SF 7
Fixationsklemmen	<i>Fixation Clamps</i>	SF 8
Griffe	<i>Handles</i>	SF 9
Osteotome & Retraktoren Schmiedeteile	<i>Osteotomes & Retractors Forgings</i>	SF 10
Zangen Schmiede	<i>Pliers Forgings</i>	SF 11
Ringgriffklemmen	<i>Ring Handle Clamps</i>	SF 12-13
Kerrison Nagetierte	<i>Rongeurs Kerrison</i>	SF 14
Knochen nagetierte	<i>Rongeurs Bone</i>	SF 15
Scheren und Rod Benders	<i>Scissors & Rod Bender</i>	SF 16



©ZZE MEDICAL & SURGICAL SUPPLIES

TOOLS TO OPERATE



ONE

🖱 www.ozzesurgical.com.au

✉ info@ozzesurgical.com.au

Standard-Schere

hergestellt aus hochwertigem Edelstahl

Standard Scissors

manufactured of high grade stainless steel



OZ-1331-18

SuperCut-Schere (MC)

unteres Blatt mit rasiermesserscharfer Schneide
oberes Blatt mikrofein gezahnt

Erkennungsmerkmale: +
schwarze Ringe und

+ **zusätzlich endet die Artikelnummer mit dem Buchstaben "M"**

SuperCut Scissors (MC)

lower blade with razor-sharp cutting edge
micro serrated upper blade

Identifying features: +

black rings and

+ **additionally the article number ends with the letter "M"**

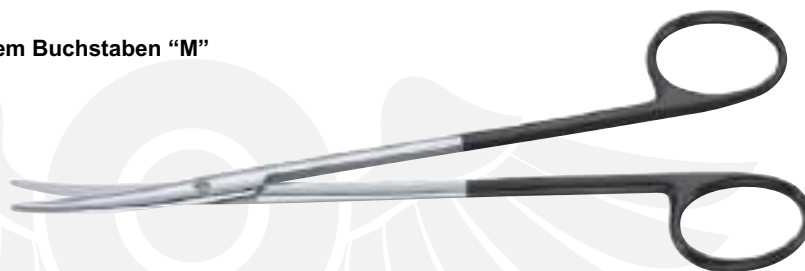

OZ-1331-18M

Schere mit Keramikbeschichtung (CC)

Keramikbeschichtung

Erkennungsmerkmale:

+ schwarze Keramikbeschichtung,

+ vergoldete Schraube und

+ **zusätzlich endet die Artikelnummer mit dem Buchstaben "C"**

Scissors with Ceramic Coating (CC)

ceramic coating

Identifying features:

+ black ceramic coating,

+ gold plated screw and

+ **additionally the article number ends with the letter "C"**



OZ-1331-18C

Oberflächenbeschreibung Surface Description

SuperCut-Schere mit Keramikbeschichtung (MC/CC)

unteres Blatt mit rasiermesserscharfer Schneide und oberes Blatt mikrofein gezahnt (MC)
Keramikbeschichtung (CC)

Erkennungsmerkmale:

- + schwarze Keramikbeschichtung,
- + vergoldete Schraube und
- + **zusätzlich endet die Artikelnummer mit dem Buchstaben "N"**



SuperCut Scissors with Ceramic Coating (MC/CC)

OZ-1331-18N

lower blade with razor-sharp cutting edge and microfine serrated upper blade (MC)
ceramic coating (CC)

Identifying features:

- + black ceramic coating,
- + gold plated screw and
- + additionally the article number ends with the letter "N"

RUDOLF Supreme-Line (S)

hergestellt aus hochwertigem Edelstahl
besonderes feines Finish in der Schneide und extrem weicher Gang

Erkennungsmerkmale:

- + Hochglanzpolierte Arbeitsenden
- + Zusätzlich endet die Artikelnummer mit dem Buchstaben "S"



RUDOLF Supreme-Line (S)

manufactured of high grade stainless steel
extremely fine finish of the cutting edges and very easy cutting movement

OZ-1331-18S

Identifying features:

- + highly polished working ends
- + additionally the article number ends with the letter "S"

Hartmetallschere (TC)

Schneiden mit aufgeschweißtem Hartmetall

Erkennungsmerkmale:

- + vergoldete Ringe



Hard Metal Scissors (TC)

blades with welded hard metal

OZ-1334-18

Identifying features: +
gold plated rings

Hartmetall-SuperCut-Schere (TC/MC)

Schneiden mit aufgeschweißtem Hartmetall

unteres Blatt mit rasiermesserscharfer Schneide und oberes Blatt mikrofein gezahnt (MC)

Erkennungsmerkmale:

- + lang vergoldete Ringe und
- + zusätzlich endet die Artikelnummer mit dem Buchstaben "M"

blades with welded hard metal



M

Hard Metal SuperCut Scissors (TC/MC)

OZ-1334-18

lower blade with razor-sharp cutting edge and microfine serrated upper blade (MC)

Identifying features:

- + long gold plated rings and
- + additionally the article number ends with the letter "M"

Hartmetallschere mit Keramikbeschichtung (TC/CC)

Schneiden mit aufgeschweißtem Hartmetall
Keramikbeschichtung (CC)

Erkennungsmerkmale:

- + schwarze Keramikbeschichtung,
- + vergoldete Ringe,
- + vergoldete Schraube und
- + **zusätzlich endet die Artikelnummer mit dem Buchstaben "C"**

blades with welded hard metal



Hard Metal Scissors with Ceramic Coating (TC/CC)

OZ-1334-18C

ceramic coating (CC)

Identifying features:

- + black ceramic coating,
- + gold plated rings,
- + gold plated screw and
- + additionally the article number ends with the letter "C"

Hartmetall-SuperCut-Scheren mit Keramikbeschichtung (TC/MC/CC)

Schneiden mit aufgeschweißtem Hartmetall
unteres Blatt mit rasiermesserscharfer Schneide und oberes Blatt mikrofein gezahnt (MC)
Keramikbeschichtung (CC)

Erkennungsmerkmale:

- + schwarze Keramikbeschichtung,
- + lang vergoldete Ringe,
- + vergoldete Schraube und
- + **zusätzlich endet die Artikelnummer mit dem Buchstaben "N"**

blades with welded hard metal



Hard Metal SuperCut Scissors with Ceramic Coating (TC/MC/CC)

OZ-1334-18

lower blade with razor-sharp cutting edge and microfine serrated upper blade (MC)
ceramic coating (CC)

Identifying features:

- + black ceramic coating,
- + long gold plated rings,
- + gold plated screw and
- + additionally the article number ends with the letter "N"

Hartmetallschere mit Wellenschliff (TC/W)

Schneiden mit aufgeschweißtem Hartmetall
unteres Blatt mit feinem Wellenschliff (W)

Erkennungsmerkmale:

- + vergoldete Ringe und **W**
- + **zusätzlich endet die Artikelnummer mit dem Buchstaben "W"**

Hard Metal Scissors with Wavecut (TC/W)

blades with welded hard metal



OZ-1334-18

lower blade with fine wavecut (W)

Identifying features:

- + gold plated rings and
- + additionally the article number ends with the letter "W"



OZZE MEDICAL & SURGICAL SUPPLIES
TOOLS TO OPERATE

Mikro-Federscheren Micro Spring Scissors



Kapsulotomieschere
Capsulotomy scissors

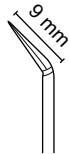

spitz / spitz
gewinkelt
sharp / sharp
angled

8 cm – 3¼"

OZ-2231-08

1:1

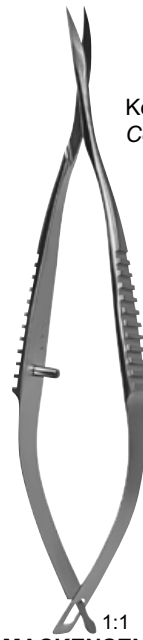

Keratoplastikschere
Cerato-plastic scissors



spitz / spitz
gebogen
sharp / sharp
curved

8 cm – 3¼"

OZ-2232-08

1:1

MACKENSEN



spitz / spitz
leicht gebogen
sharp / sharp
slightly curved

8 cm – 3¼"

OZ-2233-04

1:1



spitz / spitz
gewinkelt
sharp / sharp
angled

8 cm – 3¼"

OZ-2233-06

1:1



Mikro-Federscheren Micro Spring Scissors



spitz / spitz
sharp / sharp



stumpf / spitz
blunt / sharp



stumpf / stumpf
blunt / blunt



spitz / stumpf
sharp / blunt

Blattlänge 7 mm
Length of blades 7 mm

11 cm – 4½"

Iridektomieschere
Iridectomy scissors

OZ-2221-07	OZ-2222-07	OZ-2223-07	OZ-2224-07
------------	------------	------------	------------



WECKER

gewinkelt
angled



spitz / spitz
sharp / sharp



stumpf / spitz
blunt / sharp



stumpf / stumpf
blunt / blunt



spitz / stumpf
sharp / blunt

Blattlänge 11 mm
Length of blades 11 mm

11 cm – 4½"

OZ-2221-11	OZ-2222-11	OZ-2223-11	OZ-2224-11
------------	------------	------------	------------

Iridektomieschere
Iridectomy scissors



NOYES



spitz / spitz
sharp / sharp

12 cm – 4¾"

OZ-2200-01

Iridektomieschere
Iridectomy scissors



NOYES



spitz / spitz
gewinkelt
sharp / sharp
angled

12 cm – 4¾"

OZ-2201-01



Mikro-Federscheren Micro Spring Scissors



Sehnenschere
Tenotomy scissors

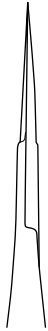

spitz / spitz
gerade
*sharp / sharp
straight*

11,5 cm – 4½"

OZ-2240-11

1:1
WESTCOTT

Sehnenschere
Tenotomy scissors

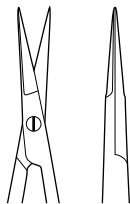

spitz / spitz
gerade
*sharp / sharp
straight*



spitz / spitz
gewinkelt
*sharp / sharp
angled*

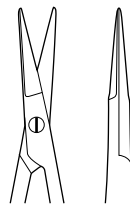

stumpf / stumpf
gerade
*blunt / blunt
straight*



stumpf / stumpf
gebogen
*blunt / blunt
curved*



stumpf / stumpf
gewinkelt
*blunt / blunt
angled*

9,5 cm – 3¾"

1:1

OZ-2244-09

OZ-2248-09

OZ-2246-09

OZ-2247-09

OZ-2250-09



Mikro-Federscheren Micro Spring Scissors



stumpf / stumpf
gerade
blunt / blunt
straight



stumpf / stumpf
gebogen
blunt / blunt
curved



spitz / spitz
gewinkelt
sharp / sharp
angled



stumpf / stumpf
gewinkelt
blunt / blunt
angled

8,5 cm – 3¼"

OZ-2260-08

OZ-2261-08

OZ-2262-08

OZ-2263-08



Nachstarschere
Secondary cataract scissors



stumpf / stumpf
gerade
blunt / blunt
straight



stumpf / stumpf
gebogen
blunt / blunt
curved

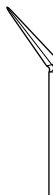

spitz / spitz
gewinkelt
sharp / sharp
angled



stumpf / stumpf
gewinkelt
blunt / blunt
angled

8,5 cm – 3¼"

OZ-2270-08

OZ-2271-08

OZ-2272-08

OZ-2273-08

VANNAS, MODELL TÜBINGEN
VANNAS, TUEBINGER PATTERN



Mikro-Federscheren Micro Spring Scissors



1:1
CASTROVIEJO

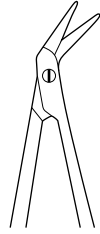

stumpf / stumpf
gewinkelt
blunt / blunt
angled

10 cm – 4"

OZ-2286-10



1:1
CASTROVIEJO



spitz / spitz
gebogen
sharp / sharp
curved

10 cm – 4"

OZ-2300-10

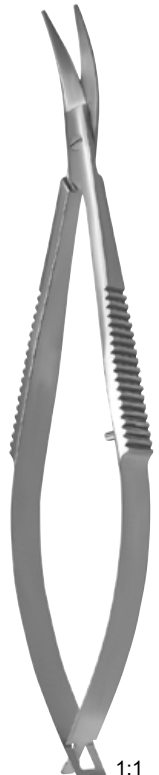

1:1
CASTROVIEJO



stumpf / stumpf
gebogen
blunt / blunt
curved

10 cm – 4"

OZ-2310-10



1:1
TROUTMAN



rechts
right

10 cm – 4"

OZ-2316-10

Hornhautschere
Corneal scissors



Mikro-Federscheren Micro Spring Scissors



Hornhautschere
Corneal scissors



links
left

10 cm – 4"

OZ-2338-10

1:1
CASTROVIEJO



Hornhautschere
Corneal scissors



rechts
right

10 cm – 4"

OZ-2339-10

1:1
CASTROVIEJO



Hornhautschere
Corneal scissors



links
left

11 cm – 4¼"

OZ-2345-11

1:1
CASTROVIEJO



Hornhautschere
Corneal scissors



rechts
right

11 cm – 4¼"

OZ-2340-11

1:1
CASTROVIEJO



Mikro-Federscheren Micro Spring Scissors

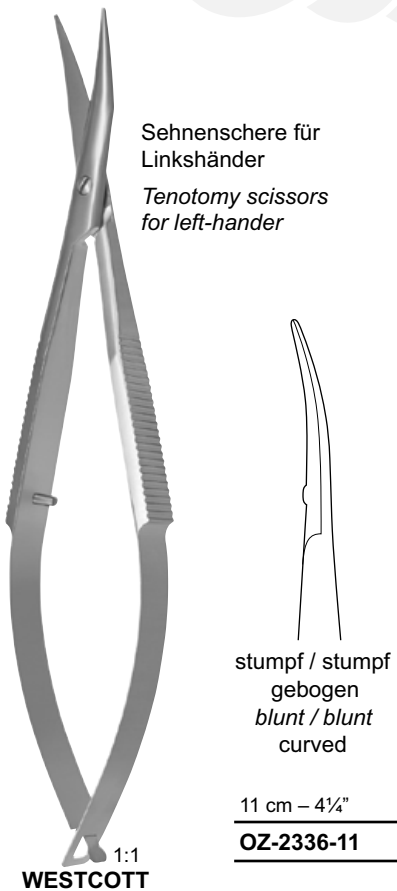
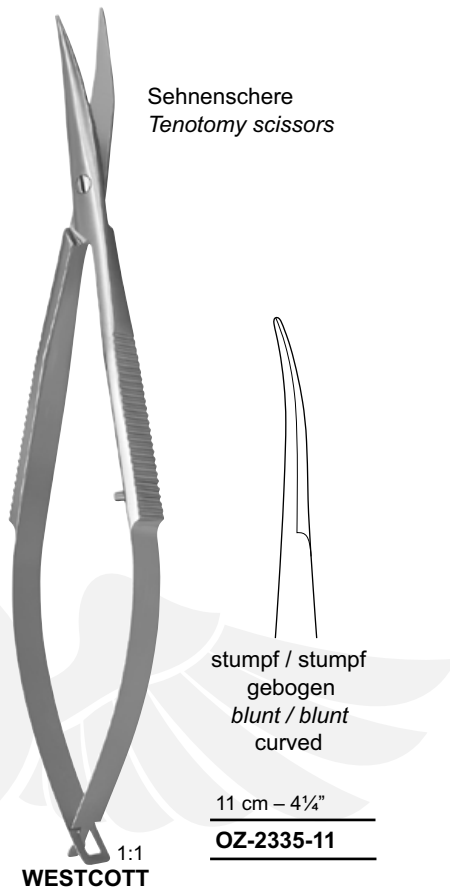
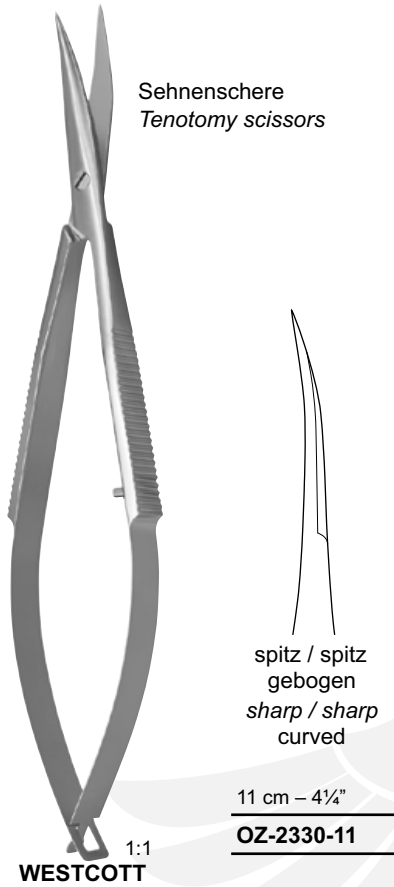



Mikro-Federscheren Micro Spring Scissors



1:1

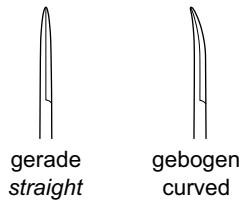

10,5 cm – 4 1/4"

OZ-2368-10 | **OZ-2369-10**

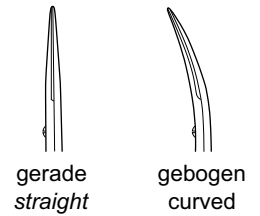

12 cm – 4 3/4"	OZ-2254-02	OZ-2254-03
16 cm – 6 1/4"	OZ-2254-22	OZ-2254-23
18,5 cm – 7 1/4"	OZ-2254-32	OZ-2254-33

Venenschere

kein Abgleiten des Gefäßes
glatte, saubere Durchtrennung

Vein scissors

vessel cannot slip off
clean, smooth cut



BIEMER



13 cm – 5"

OZ-2370-01

Mikro-Federscheren Micro Spring Scissors



STREAMLINE

durch den geschwungenen Schluss verfängt sich der Faden nicht mehr, sondern gleitet über die Oberfläche.

weniger Reparatur anfällig

because of the curved lock design the suture does not get caught and slides over the surface.

less prone to repairs

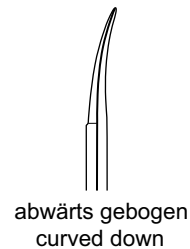
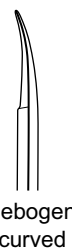
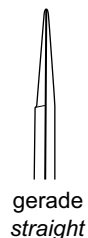

16,5 cm – 6½"	OZ-2252-22	OZ-2252-23	–
20 cm – 8"	OZ-2252-42	OZ-2252-43	OZ-2252-41
22,5 cm – 9"	OZ-2253-52	OZ-2253-53	–
24,5 cm – 9¾"	OZ-2253-62	OZ-2253-63	–

 STREAMLINE	20 cm – 8"	OZ-2252-42R	OZ-2252-43R	–
	22,5 cm – 9"	OZ-2253-52R	OZ-2253-53R	–

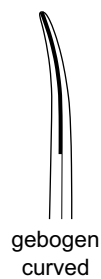
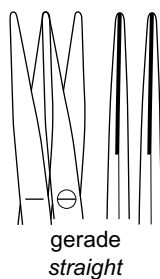

16,5 cm – 6½"	OZ-2252-28	–
18,5 cm – 7½"	OZ-2252-38	–
20 cm – 8"	OZ-2252-48	OZ-2252-49
22,5 cm – 9"	OZ-2253-58	OZ-2253-59

 STREAMLINE	20 cm – 8"	OZ-2252-48R	OZ-2252-49R
	22,5 cm – 9"	OZ-2253-58R	OZ-2253-59R



Mikro-Federscheren Micro Spring Scissors



STREAMLINE

durch den geschwungenen Schluss verfängt sich der Faden nicht mehr, sondern gleitet über die Oberfläche.

weniger Reparatur anfällig

because of the curved lock design the suture does not get caught and slides over the surface.

less prone to repairs

Titanium



gerade
straight



gebogen-
curved

	16 cm – 6¼"	OZ-2370-16R	OZ-2371-16R
	18 cm – 7"	OZ-2370-18R	OZ-2371-18R
STREAMLINE			



gerade
straight



gebogen
curved

14 cm – 5½"	TI	OZ-2380-14T	OZ-2388-14T
-------------	-----------	--------------------	--------------------

	15 cm – 6"	OZ-2380-16R	OZ-2381-16R
	STREAMLINE		

TI = Titan /



Mikro-Federscheren Micro Spring Scissors



JACOBSON



gerade
straight



gebogen
curved

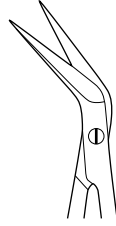

gewinkelt
angled

18 cm – 7"

OZ-2350-18	OZ-2351-18	OZ-2352-18
------------	------------	------------



bajonettförmig
bayonet-shaped



gerade
straight



gebogen
curved

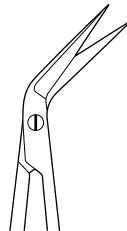

gewinkelt
angled

19 cm – 7½"

OZ-2360-19	OZ-2361-19	OZ-2362-19
------------	------------	------------

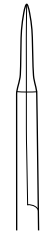

gerade
straight

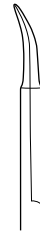

gebogen
curved

VANNAS

19 cm – 7½"	OZ-2364-19	OZ-2365-19
-------------	------------	------------



Mikro-Federscheren Micro Spring Scissors



gerade
straight



gebogen
curved



gerade
straight

18,5 cm – 7¼"	TI	OZ-2382-18T	OZ-2383-18T	–
23 cm – 9"	TI	–	–	OZ-2382-23T

Evolution / Nano

leichter als Titan dank neuem Griff-Design alle Vorzüge von Edelmetallinstrumenten außergewöhnlich gute Haptik für präzises Arbeiten problemloses Reinigen für bestmögliche Hygiene optimale Ergonomie dank der runden Griffschalen

Evolution / Nano

lighter than titanium thanks to the new handle design all advantages of stainless steel instruments unsurpassed haptic for precision during the operation easy cleaning for best possible hygiene optimal ergonomomy due to the round shell handles



Nano



gerade
straight



gebogen
curved

15 cm – 6"

OZ-2380-75	OZ-2381-75
------------	------------



Evolution



gerade
straight



gebogen
curved

12 cm – 4¾"	OZ-2380-82	OZ-2381-82
15 cm – 6"	OZ-2380-85	OZ-2381-85
18 cm – 7"	OZ-2380-88	OZ-2381-88







TI = Titan / Titanium

Feine Scheren Delicate Scissors







Augenschere
Eye scissors

KNAPP

					
stumpf / stumpf blunt / blunt	spitz / stumpf sharp / blunt	spitz / spitz sharp / sharp	stumpf / stumpf blunt / blunt	spitz / stumpf sharp / blunt	spitz / spitz sharp / sharp
geradestraight			gebogencurved		
10,5 cm – 4¼"			10,5 cm – 4¼"		
OZ-2404-01	OZ-2404-02	OZ-2404-03	OZ-2405-01	OZ-2405-02	OZ-2405-03





Iris- und
Fadenschere
Iris and
suture scissors

			
gerade straight	gebogen curved	gerade straight	gebogen curved
OZ-2420-09	OZ-2421-09	OZ-2422-09	OZ-2423-09
9,5 cm – 3¾"			
10,5 cm – 4¼"	OZ-2420-10	OZ-2421-10	OZ-2422-10
11,5 cm – 4½"	OZ-2420-11	OZ-2421-11	OZ-2422-11

FINO



große Ringe
large rings

	
gerade straight	gebogen curved
10 cm – 4"	
OZ-2426-10	OZ-2427-10



Feine Scheren Delicate Scissors

Irisschere mit fl achen Branchen
Iris scissors »Ribbon Type«



Irisschere mit fl achen Branchen
Iris scissors »Ribbon Type«

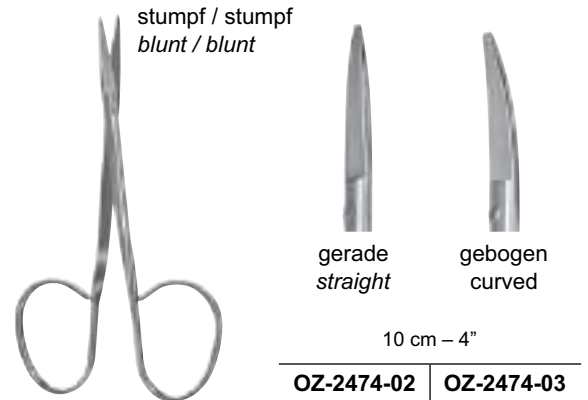

Irisschere mit fl achen Branchen
Iris scissors »Ribbon Type«

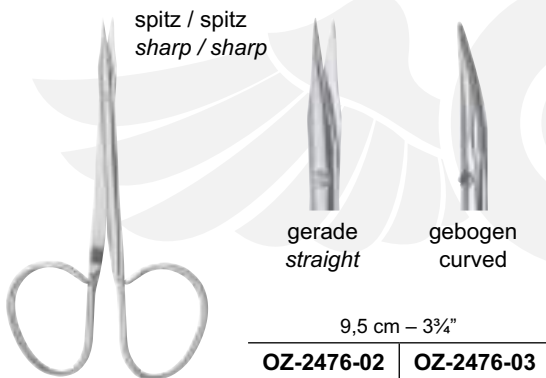

Irisschere mit fl achen Branchen
Iris scissors »Ribbon Type«

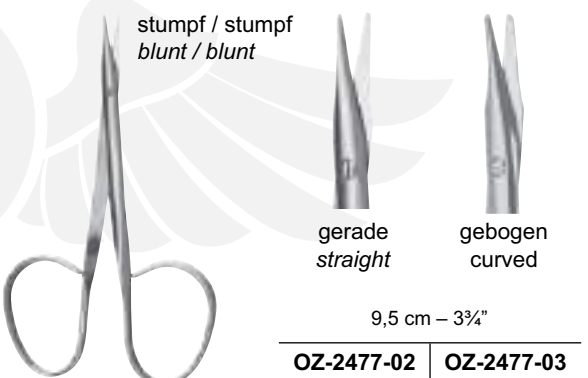

Irisschere mit fl achen Branchen
Iris scissors »Ribbon Type«

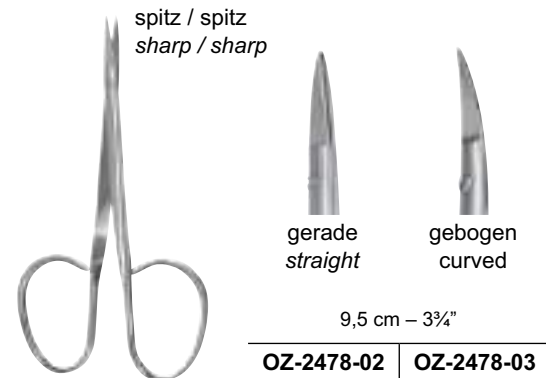

Anatomie-Schere
Dissecting scissors

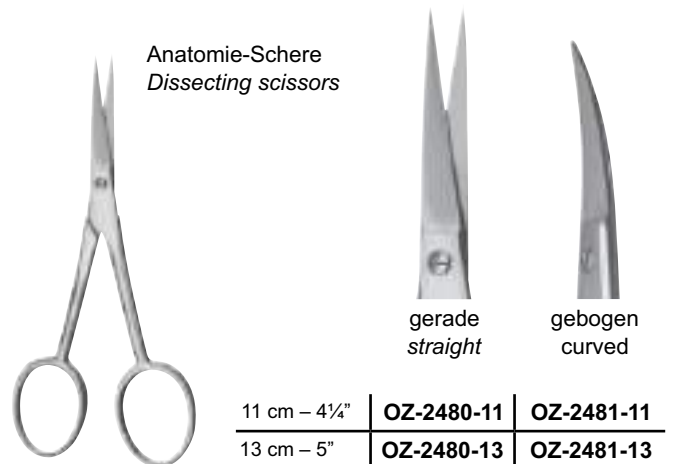



Feine Scheren Delicate Scissors

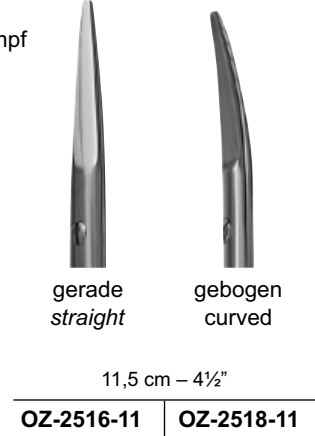
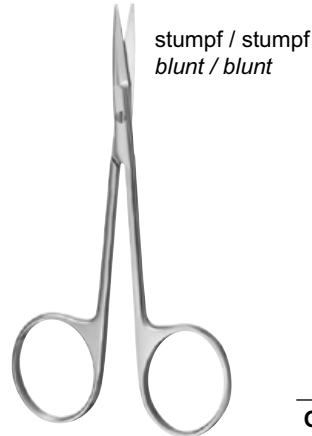
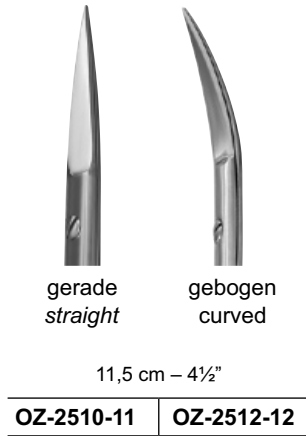

Sehnenschere Tenotomy scissors

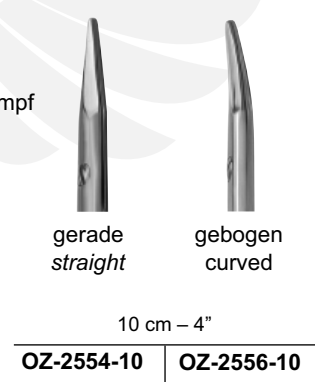
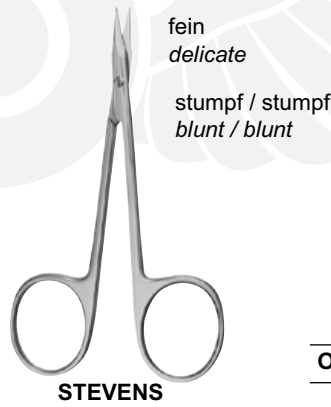
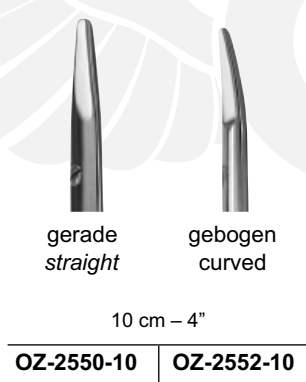



Feine Scheren Delicate Scissors

Strabismus Scheren Strabismus scissors



gerade
straight



leicht gebogen
slightly curved



gebogen
curved

11,5 cm – 4½"

OZ-2570-11

OZ-2571-11

OZ-2572-11

Fadenschere Stitch scissors



gebogen
curved

10 cm – 4"

OZ-2595-10

REEH



gerade
straight



gebogen
curved

10,5 cm – 4¼"

OZ-2584-10

OZ-2585-10

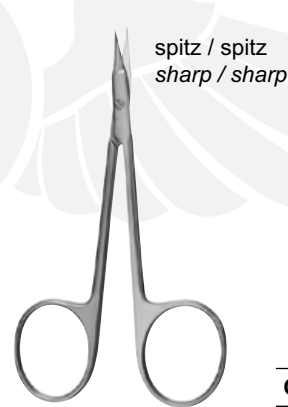

gerade
straight



gebogen
curved

10 cm – 4"

OZ-2590-10

OZ-2592-10

Irisschere, fein Iris scissors, delicate



gerade
straight



gebogen
curved

10 cm – 4"

OZ-2596-10

OZ-2597-10

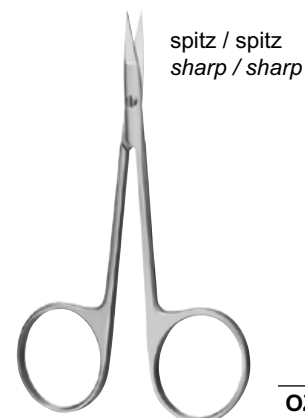

gerade
straight



gebogen
curved

11 cm – 4¼"

OZ-2598-11

OZ-2599-11



Feine Scheren Delicate Scissors



gerade
straight



gebogen
curved



Typ / Type	9 cm – 3½"	
	OZ-1630-09	OZ-1631-09
MC	OZ-1630-09M	OZ-1631-09M
CC	OZ-1630-09C	OZ-1631-09C
TC	OZ-2406-09	OZ-2407-09
TC/MC	OZ-2406-09M	OZ-2407-09M
TC/CC	OZ-2406-09C	OZ-2407-09C
TC/MC/CC	OZ-2406-09N	OZ-2407-09N

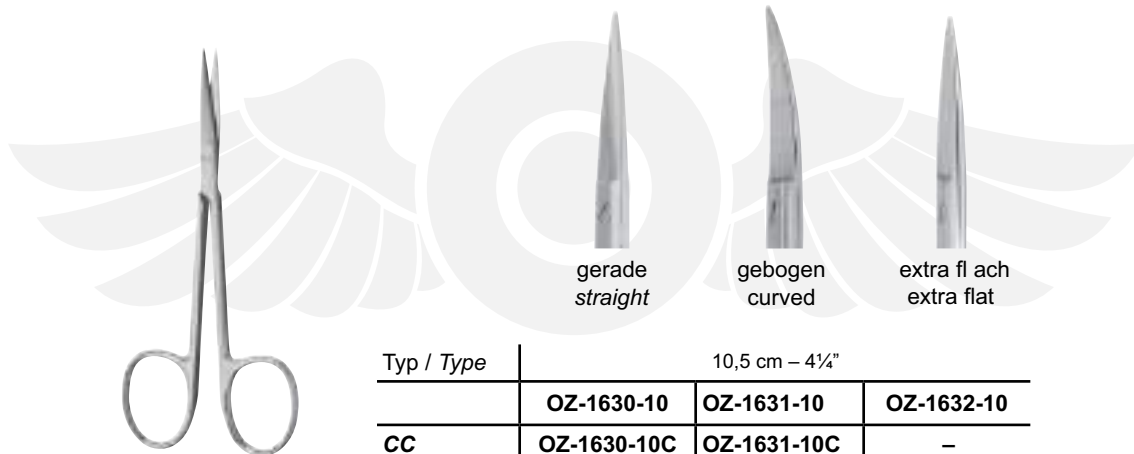

gerade
straight

gebogen
curved

extra fl ach
extra flat

Typ / Type	10,5 cm – 4¼"		
	OZ-1630-10	OZ-1631-10	OZ-1632-10
CC	OZ-1630-10C	OZ-1631-10C	–



FINO



gerade
straight



gebogen
curved

10,5 cm – 4¼"

OZ-2418-10	OZ-2419-10
-------------------	-------------------

MC = SuperCut-Schere / SuperCut scissors
= Hartmetallschere / hard metal scissors

CC = Keramikbeschichtete Schere / Ceramic coated scissors
= Wellenschliff-Schere / Wavecut scissors



Feine Scheren Delicate Scissors



stumpf / stumpf
blunt / blunt



spitz / stumpf
sharp / blunt



stumpf / stumpf
blunt / blunt



spitz / stumpf
sharp / blunt

gerade
straight

gebogen
curved

11,5 cm – 4½"

11,5 cm – 4½"

OZ-2396-01	OZ-2396-02	OZ-2397-01	OZ-2397-02
-------------------	-------------------	-------------------	-------------------



gerade
straight



gebogen
curved



gewinkelt
angled



sichelförmig
sickle shaped

Typ / Type

11,5 cm – 4½"

	OZ-1630-11	OZ-1631-11	OZ-2414-11	OZ-2416-11
MC	OZ-1630-11M	OZ-1631-11M	–	–
CC	OZ-1630-11C	OZ-1631-11C	–	–
MC/CC	OZ-1630-11N	OZ-1631-11N	–	–
TC	OZ-2406-11	OZ-2407-11	–	–
TC/MC	OZ-2406-11M	OZ-2407-11M	–	–
TC/CC	OZ-2406-11C	OZ-2407-11C	–	–
TC/MC/CC	OZ-2406-11N	OZ-2407-11N	–	–



FINO



gerade
straight



gebogen
curved

11,5 cm – 4½"

OZ-2418-11	OZ-2419-11
-------------------	-------------------

MC = SuperCut-Schere / SuperCut scissors TC
= Hartmetallschere / hard metal scissors

CC = Keramikbeschichtete Schere / Ceramic coated scissors W
= Wellenschliff-Schere / Wavecut scissors

Feine Scheren Delicate Scissors



gewinkelt
angled

9 cm – 3½"

OZ-1636-09



gebogen
curved

10 cm – 4"

OZ-1638-10

WALTON



gerade
straight

14,5 cm – 5¾"

OZ-1640-14

SANVENERO



gebogen
curved

14,5 cm – 5¾"

OZ-1641-14

SANVENERO



Feine chirurgische Scheren Delicate Surgical Scissors



stumpf / stumpf
blunt / blunt

spitz / stumpf
sharp / blunt

Fig. 1

-	gerade straight	gebogen- curved	gerade- straight	gebogen- curved
12 cm – 4¾"	OZ-1501-12	OZ-1511-12	OZ-1502-12	OZ-1512-12



spitz / spitz
sharp / sharp

Fig. 3

	Typ Type	gerade- straight	gebogen- curved
12 cm – 4¾"		OZ-1503-12	OZ-1513-12
	MC	OZ-1503-12M	OZ-1513-12M

MC = SuperCut-Schere / SuperCut scissors TC
= Hartmetallschere / hard metal scissors

CC = Keramikbeschichtete Schere / Ceramic coated scissors W
= Wellenschliff-Schere / Wavecut scissors

Feine chirurgische Scheren Delicate Surgical Scissors



WAGNER



stumpf / stumpf
blunt / blunt

Fig. 1

spitz / stumpf
sharp / blunt

Fig. 2

-	gerade straight	gebogen- curved	gerade- straight	gebogen- curved
12 cm – 4¾"	OZ-1521-12	OZ-1524-12	OZ-1522-12	OZ-1525-12



WAGNER



spitz / spitz
sharp / sharp

Fig. 3

	Typ Type	gerade- straight	gebogen- curved
12 cm – 4¾"		OZ-1523-12	OZ-1526-12
	MC	OZ-1523-12M	OZ-1526-12M

MC = SuperCut-Schere / SuperCut scissors TC
= Hartmetallschere / hard metal scissors

CC = Keramikbeschichtete Schere / Ceramic coated scissors W
= Wellenschliff-Schere / Wavecut scissors



Feine chirurgische Scheren Delicate Surgical Scissors



BROPHY (SULLIVAN)



spitz / spitz
sharp / sharp

-	gerade straight
14,5 cm – 5¾"	OZ-1550-14



BROPHY (SULLIVAN)



spitz / spitz
sharp / sharp

-	gebogen curved
14,5 cm – 5¾"	OZ-1551-14

Chirurgische Scheren Surgical Scissors



stumpf / stumpf
blunt / blunt
gerade / straight



stumpf / stumpf
blunt / blunt gebogen / curved

	Typ Type	geradestraight	gebogencurved
10,5 cm – 4¼"		OZ-1001-10	OZ-1011-10
11,5 cm – 4½"		OZ-1001-11	OZ-1011-11
13 cm – 5"		OZ-1001-13	OZ-1011-13
14,5 cm – 5¾"	TC	OZ-1004-14	OZ-1014-14
	TC/CC	OZ-1004-14C	OZ-1014-14C
15,5 cm – 6"		OZ-1001-15	OZ-1011-15
16,5 cm – 6½"		OZ-1001-16	OZ-1011-16
17,5 cm – 7"		OZ-1001-17	OZ-1011-17
18,5 cm – 7"		OZ-1001-18	OZ-1011-18
20 cm – 8"		OZ-1001-20	OZ-1011-20



spitz / stumpf
sharp / blunt
gerade / straight



spitz / stumpf
sharp / blunt gebogen / curved

	Typ Type	geradestraight	gebogencurved
10,5 cm – 4¼"		OZ-1002-10	OZ-1012-10
11,5 cm – 4½"		OZ-1002-11	OZ-1012-11
13 cm – 5"		OZ-1002-13	OZ-1012-13
14,5 cm – 5¾"		OZ-1002-14	OZ-1012-14
	MC	OZ-1002-14M	OZ-1012-14M
	CC	OZ-1002-14C	OZ-1012-14C
	MC/CC	OZ-1002-14N	OZ-1012-14N
	TC	OZ-1006-14	OZ-1016-14
	TC/CC	OZ-1006-14C	OZ-1016-14C
15,5 cm – 6"		OZ-1002-15	OZ-1012-15
16,5 cm – 6½"		OZ-1002-16	OZ-1012-16
17,5 cm – 7"		OZ-1002-17	OZ-1012-17
18,5 cm – 7¼"		OZ-1002-18	OZ-1012-18
20 cm – 8"		OZ-1002-20	OZ-1012-20

MC = SuperCut-Schere / SuperCut scissors
TC = Hartmetallschere / hard metal scissors

CC = Keramikbeschichtete Schere / Ceramic coated scissors
W = Wellenschliff-Schere / Wavecut scissors

Chirurgische Scheren Surgical Scissors

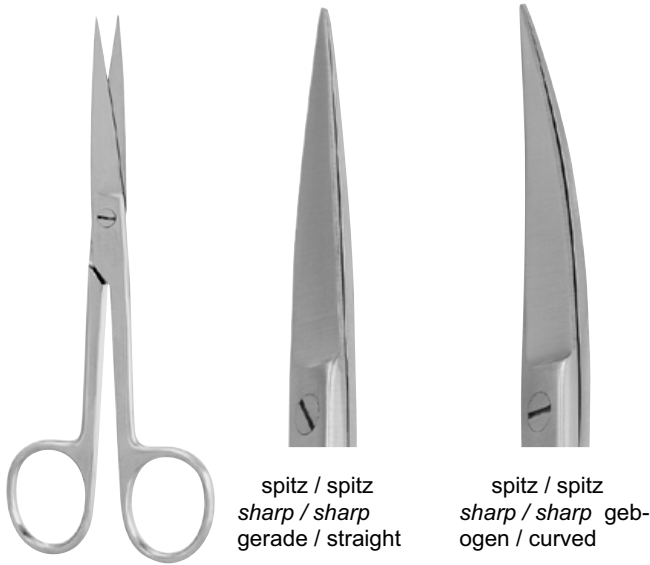

spitz / spitz
sharp / sharp
gerade / straight

spitz / spitz
sharp / sharp gebogen / curved

	Typ Type	geradestraight	gebogencurved
10,5 cm – 4¼"		OZ-1003-10	OZ-1013-10
11,5 cm – 4½"		OZ-1003-11	OZ-1013-11
13 cm – 5"		OZ-1003-13	OZ-1013-13
14,5 cm – 5¾"		OZ-1003-14	OZ-1013-14
	TC	OZ-1008-14	OZ-1018-14
	TC/CC	OZ-1008-14C	OZ-1018-14C
15,5 cm – 6"		OZ-1003-15	OZ-1013-15
16,5 cm – 6½"		OZ-1003-16	OZ-1013-16
17,5 cm – 7"		OZ-1003-17	OZ-1013-17
18,5 cm – 7¼"		OZ-1003-18	OZ-1013-18
20 cm – 8"		OZ-1003-20	OZ-1013-20

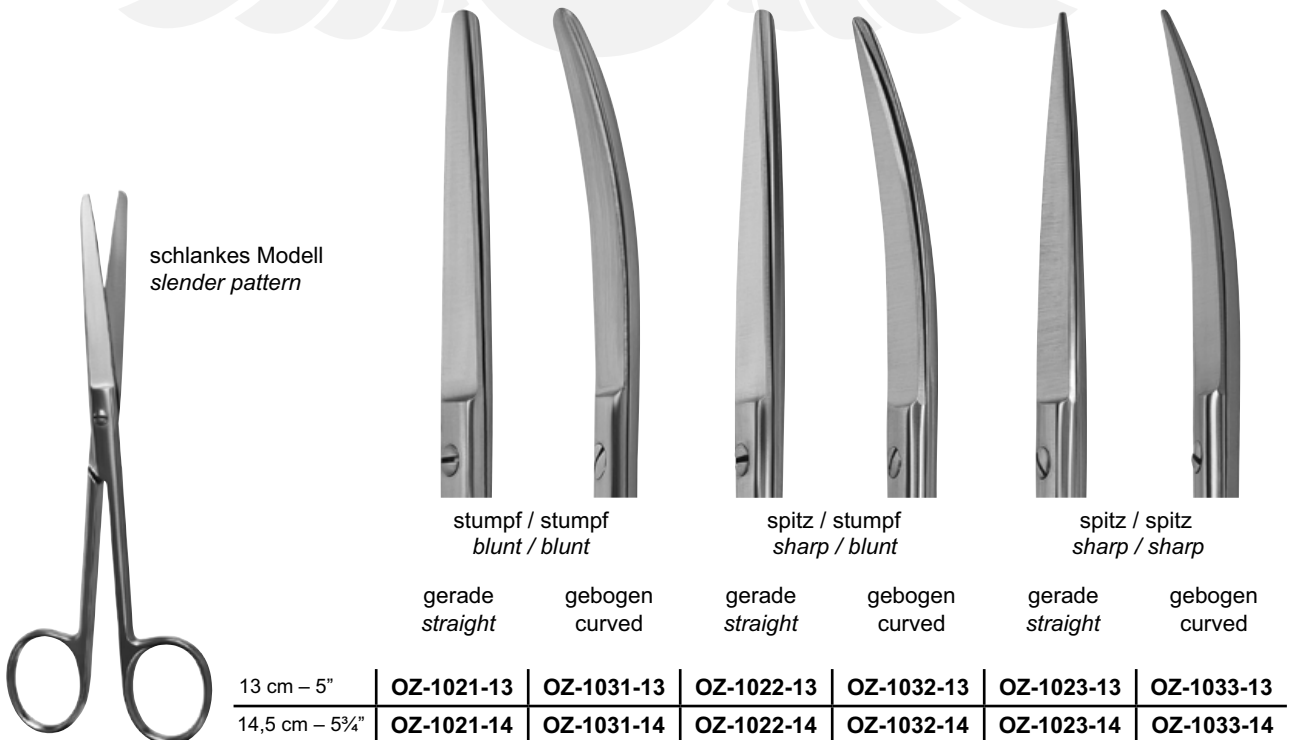
schlankes Modell
slender pattern

stumpf / stumpf
blunt / blunt

spitz / stumpf
sharp / blunt

spitz / spitz
sharp / sharp

gerade
straight

gebogen
curved

gerade
straight

gebogen
curved

gerade
straight

gebogen
curved

13 cm – 5"	OZ-1021-13	OZ-1031-13	OZ-1022-13	OZ-1032-13	OZ-1023-13	OZ-1033-13
14,5 cm – 5¾"	OZ-1021-14	OZ-1031-14	OZ-1022-14	OZ-1032-14	OZ-1023-14	OZ-1033-14

MC = SuperCut-Schere / SuperCut scissors
= Hartmetallschere / hard metal scissors

CC = Keramikbeschichtete Schere / Ceramic coated scissors
= Wellenschliff-Schere / Wavecut scissors



Chirurgische Scheren Surgical Scissors

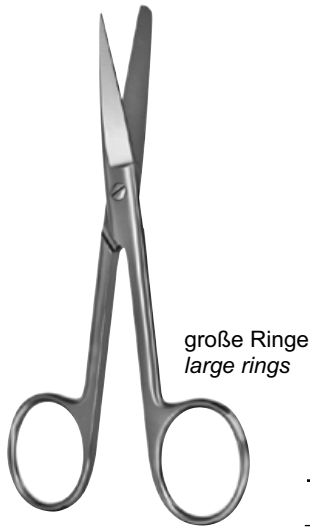

große Ringe
large rings

RUDOLF



spitz / stumpf
gerade
sharp / blunt
straight

14,5 cm – 5¾"
OZ-1000-14

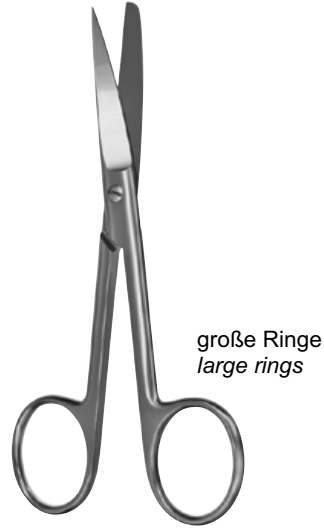

große Ringe
large rings

RUDOLF



spitz / stumpf
gebogen
sharp / blunt
curved

14,5 cm – 5¾"
OZ-1010-14



DEAVER

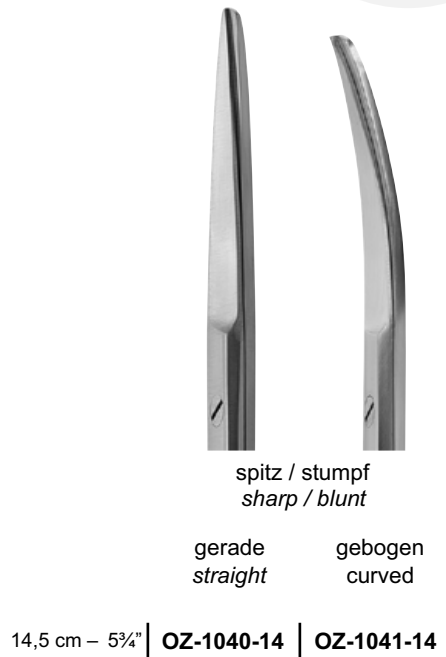

spitz / stumpf
sharp / blunt

gerade
straight

gebogen
curved

14,5 cm – 5¾" | **OZ-1040-14** | **OZ-1041-14**



Chirurgische Scheren Surgical Scissors



Inzisionsschere
Incision scissors

13



<i>straight</i>	<i>gerade</i>
cm – 5"	OZ-1110-13
14,5 cm – 5¾"	OZ-1110-14
16,5 cm – 6½"	OZ-1110-16



Inzisionsschere
Incision scissors



gerade
straight

15,5 cm – 6"
OZ-1112-15



Chirurgische Scheren Surgical Scissors



spitz / stumpf
seitwärts gewinkelt
*sharp / blunt angled
to side*



14,5 cm – 5¾"

OZ-1120-14

RICHTER



stumpf / stumpf seit-
wärts gewinkelt *blunt*
/ blunt angled to side



14,5 cm – 5¾"

OZ-1122-14

RICHTER



spitz / spitz
gebogen *sharp*
/ sharp curved



14,5 cm – 5¾"

OZ-1132-14

NEW SUTURE



spitz / spitz
gebogen *sharp*
/ sharp curved



18,5 cm – 7¼"

OZ-1130-18

FERGUSSON



Feine Präparierscheren Delicate Dissecting Scissors



Sehnenschere
Tenotomy scissors

STEVENS

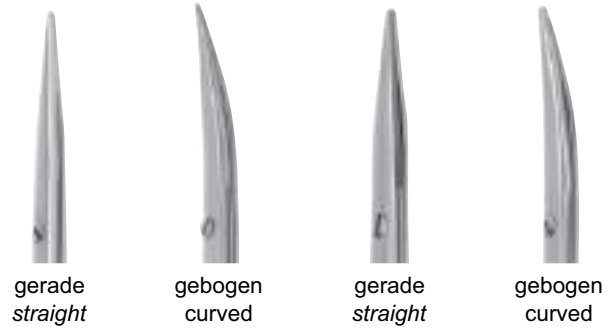

gerade
straight

gebogen
curved

gerade
straight

gebogen
curved

Typ Type		spitzsharp		stumpfbunt	
10,5 cm – 4¼"		OZ-2430-10	OZ-2431-10	OZ-2440-10	OZ-2441-10
	MC	–	–	OZ-2440-10M	OZ-2441-10M
11,5 cm – 4½"		OZ-2430-11	OZ-2431-11	OZ-2440-11	OZ-2441-11
	MC	OZ-2430-11M	OZ-2431-11M	OZ-2440-11M	OZ-2441-11M
	CC	–	–	OZ-2440-11C	OZ-2441-11C
	TC	–	–	OZ-2440-51	OZ-2441-51



Sehnenschere
Tenotomy scissors

KLEINERT-KUTZ



stumpf / stumpf
gebogen
blunt / blunt
curved

12,5 cm – 5"

OZ-2433-12



Sehnenschere
Tenotomy scissors

STEVENS- RUDOLF



leicht gebogen,
stumpf
slightly curved,
blunt

Typ / Type | 9,5 cm – 3¾"

MC | **OZ-2441-09M**

MC = SuperCut-Schere / SuperCut scissors TC
= Hartmetallschere / hard metal scissors

CC = Keramikbeschichtete Schere / Ceramic coated scissors W
= Wellenschliff-Schere / Wavecut scissors



Feine Präparierscheren Delicate Dissecting Scissors



**MODELL BONN
BONN PATTERN**



gerade
straight



gebogen
curved

Typ / Type	8 cm – 3¼"	
	OZ-2450-08	OZ-2451-08
MC	OZ-2450-08M	OZ-2451-08M



GRAEFE



gewinkelt
angled

	10,5 cm – 4¼"
	OZ-2455-10



WILMER



gewinkelt
angled

Typ / Type	10 cm – 4"
	OZ-2457-10



WILMER



gewinkelt
angled

Typ / Type	11,5 cm – 4½"
TC	OZ-2458-10

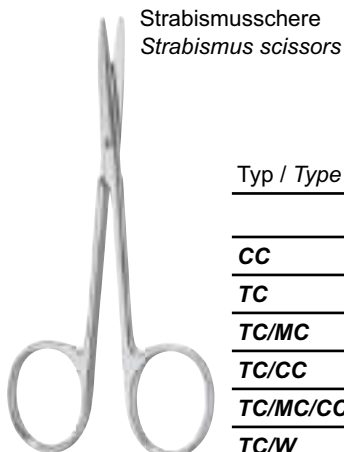

Strabismusschere
Strabismus scissors



gerade
straight



gebogen
curved

Typ / Type	11,5 cm – 4½"	
	OZ-2460-11	OZ-2461-11
CC	OZ-2460-11C	OZ-2461-11C
TC	OZ-2462-11	OZ-2463-11
TC/MC	OZ-2462-11M	OZ-2463-11M
TC/CC	OZ-2462-11C	OZ-2463-11C
TC/MC/CC	–	OZ-2463-11N
TC/W	OZ-2462-11W	OZ-2463-11W

MC = SuperCut-Schere / *SuperCut scissors*
= Hartmetallschere / *hard metal scissors*

CC = Keramikbeschichtete Schere / *Ceramic coated scissors* W
= Wellenschliff-Schere / *Wavecut scissors*



Feine Präparierscheren Delicate Dissecting Scissors



GOLDMANN-FOX

oberes Blatt
mikrofein gezahnt
*micro serrated
upper blade*

Zahnfleissschere
Gum scissors



gerade
straight

gebogen
curved

13 cm – 5"

OZ-2900-13	OZ-2901-13
-------------------	-------------------



GOLDMANN-FOX

oberes Blatt
mikrofein gezahnt
*micro serrated
upper blade*



gerade
straight

gebogen
curved

13 cm – 5"

Typ / Type	13 cm – 5"	
TC	OZ-2902-13	OZ-2903-13

MC = SuperCut-Schere / *SuperCut scissors* TC
= Hartmetallschere / *hard metal scissors*

CC = Keramikbeschichtete Schere / *Ceramic coated scissors* W
= Wellenschliff-Schere / *Wavecut scissors*



Feine Präparierscheren Delicate Dissecting Scissors



GOLDMANN-FOX

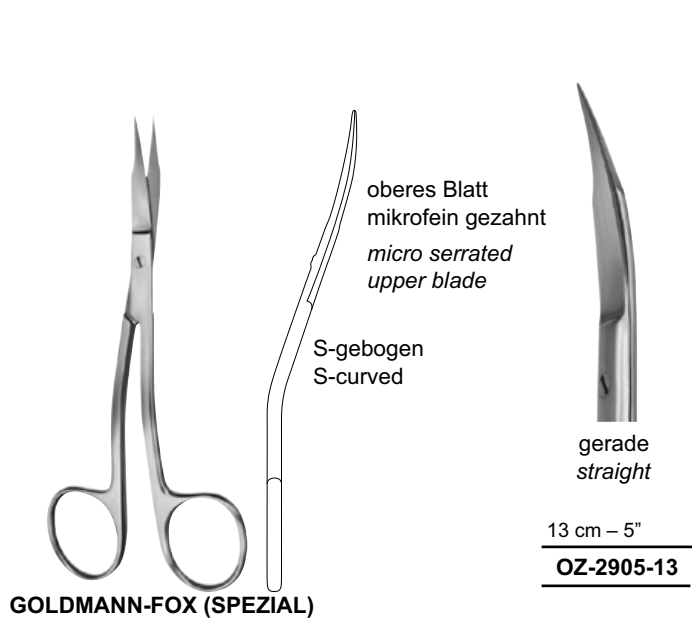

GOLDMANN-FOX (SPEZIAL)

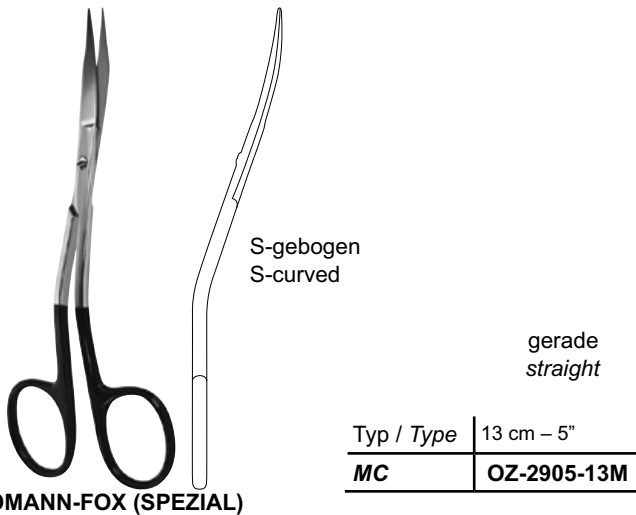

GOLDMANN-FOX (SPEZIAL)

MC = S uperCut-Schere / SuperCut scissors TC
= Hartmetallschere / hard metal scissors

CC = Keramikbeschichtete Schere / Ceramic coated scissors W
= Wellenschliff-Schere / Wavecut scissors



Feine Präparierscheren Delicate Dissecting Scissors



REYNOLDS



gerade
straight



gebogen
curved



gerade
straight



gebogen
curved

Typ / Type	15,5 cm – 6"		18 cm – 7"	
	OZ-1580-15	OZ-1581-15	OZ-1580-18	OZ-1581-18
MC	OZ-1580-15M	OZ-1582-15M	–	OZ-1581-18M
CC	–	OZ-1581-15C	–	OZ-1581-18C



JAMESON



Typ / Type	14,5 cm – 5¾"	18 cm – 7"
	OZ-1583-15	–
MC	OZ-1583-15M	OZ-1583-18M
CC	OZ-1583-15C	–

MC = SuperCut-Schere / *SuperCut scissors*
TC = Hartmetallschere / *hard metal scissors*

CC = Keramikbeschichtete Schere / *Ceramic coated scissors W*
= Wellenschliff-Schere / *Wavecut scissors*



OZZE MEDICAL & SURGICAL SUPPLIES
TOOLS TO OPERATE

Feine Präparierscheren Delicate Dissecting Scissors



JAMESON-WERBER



Typ / Type	13 cm – 5"	15 cm – 6"
	OZ-1584-13	OZ-1584-15
MC	OZ-1584-13M	OZ-1584-25M
CC	–	OZ-1584-25C



MC = SuperCut-Schere / SuperCut scissors
TC = Hartmetallschere / hard metal scissors

CC = Keramikbeschichtete Schere / Ceramic coated scissors W
= Wellenschliff-Schere / Wavecut scissors



Enukleationsscheren Enucleation Scissors



LANDOLT



gerade
straight

12,5 cm – 5"

OZ-1590-12



LANDOLT



leicht gebogen
sightly curved

12,5 cm – 5"

OZ-1592-12



LANDOLT



gebogen
curved

12,5 cm – 5"

OZ-1594-12



LANDOLT



stark gebogen
strongly curved

12,5 cm – 5"

OZ-1596-12



Präparierscheren Dissecting Scissors



LEXER



gerade
straight

gebogen
curved

Typ / Type	16 cm – 6¼"	
	OZ-1100-16	OZ-1101-16
MC	OZ-1100-16M	OZ-1101-16M
TC	OZ-1102-16	OZ-1103-16
TC/MC	OZ-1102-16M	OZ-1103-16M
TC/CC	–	OZ-1103-16C
TC/W	–	OZ-1103-16W



LEXER-FINO



gerade
straight

gebogen
curved

Typ / Type	16 cm – 6¼"	
	OZ-1104-16	OZ-1105-16
TC	OZ-1106-16	OZ-1107-16
TC/CC	–	OZ-1107-16C
TC/W	–	OZ-1107-16W

MC = SuperCut-Schere / SuperCut scissors
= Hartmetallschere / hard metal scissors

CC = Keramikbeschichtete Schere / Ceramic coated scissors
W = Wellenschliff-Schere / Wavecut scissors



Präparierscheren Dissecting Scissors



gerade
straight

MAYO



Typ / Type	14,5 cm – 5¾"	15 cm – 6"	17 cm – 6¾"
	OZ-1250-14	OZ-1250-15	OZ-1250-17
MC	OZ-1250-14M	–	OZ-1250-17M
CC	OZ-1250-14C	–	OZ-1250-17C
TC	OZ-1252-14	–	OZ-1252-17
TC/MC	OZ-1252-14M	–	OZ-1252-17M
TC/CC	OZ-1252-14C	–	OZ-1252-17C



gerade
straight

MAYO



Typ / Type	20 cm – 8"	23 cm – 9"	28 cm – 11"
	OZ-1250-20	OZ-1250-23	OZ-1250-28
MC	–	OZ-1250-23M	OZ-1250-28M
CC	–	OZ-1250-23C	–
TC	–	OZ-1252-23	–
TC/MC	–	OZ-1252-23M	–
TC/CC	–	OZ-1252-23C	–

MC = SuperCut-Schere / SuperCut scissors
TC = Hartmetallschere / hard metal scissors

CC = Keramikbeschichtete Schere / Ceramic coated scissors
W = Wellenschliff-Schere / Wavecut scissors



Präparierscheren Dissecting Scissors



gebogen
curved

MAYO



Typ / Type	14 cm – 5½"	15 cm – 6"	17 cm – 6¾"
	OZ-1251-14	OZ-1251-15	OZ-1251-17
MC	OZ-1251-14M	–	OZ-1251-17M
CC	OZ-1251-14C	–	OZ-1251-17C
TC	OZ-1253-14	–	OZ-1253-17
TC/MC	OZ-1253-14M	–	OZ-1253-17M
TC/CC	OZ-1253-14C	–	OZ-1253-17C



gebogen
curved

MAYO



Typ / Type	20 cm – 8"	23 cm – 9"	28 cm – 11"
	OZ-1251-20	OZ-1251-23	OZ-1251-28
MC	–	OZ-1251-23M	OZ-1251-28M
CC	–	OZ-1251-23C	–
TC	–	OZ-1253-23	–
TC/MC	–	OZ-1253-23M	–
TC/CC	–	OZ-1253-23C	–

MC = SuperCut-Schere / SuperCut scissors
= Hartmetallschere / hard metal scissors

CC = Keramikbeschichtete Schere / Ceramic coated scissors
= Wellenschliff-Schere / Wavecut scissors



Präparierscheren Dissecting Scissors



MAYO-STILLE



gerade
straight

Typ / Type	14,5 cm – 5¾"	17 cm – 6¾"	19 cm – 7½"
	OZ-1260-15	OZ-1260-17	OZ-1260-19
MC	OZ-1260-15M	OZ-1260-17M	–
CC	OZ-1260-15C	OZ-1260-17C	–
TC	OZ-1262-15	OZ-1262-17	–
TC/MC	OZ-1262-15M	OZ-1262-17M	–
TC/CC	OZ-1262-15C	OZ-1262-17C	–



MAYO-STILLE



gebogen
curved

Typ / Type	14,5 cm – 5¾"	17 cm – 6¾"	19 cm – 7½"	21 cm – 8¼"
	OZ-1261-15	OZ-1261-17	OZ-1261-19	OZ-1261-21
MC	OZ-1261-15M	OZ-1261-17M	–	–
CC	OZ-1261-15C	OZ-1261-17C	–	–
TC	OZ-1263-15	OZ-1263-17	–	–
TC/MC	OZ-1263-15M	OZ-1263-17M	–	–
TC/CC	OZ-1263-15C	OZ-1263-17C	–	–

MC = SuperCut-Schere / *SuperCut scissors*
TC = Hartmetallschere / *hard metal scissors*

CC = Keramikbeschichtete Schere / *Ceramic coated scissors* W
= Wellenschliff-Schere / *Wavecut scissors*



OZZE MEDICAL & SURGICAL SUPPLIES
TOOLS TO OPERATE

Präparierscheren Dissecting Scissors



MAYO-NOBLE



gerade
straight

17 cm – 6¾"

OZ-1270-17



MAYO-NOBLE



gebogen
curved

17 cm – 6¾"

OZ-1271-17



BABY-METZENBAUM



gerade
straight



gebogen
curved



gerade
straight



gebogen
curved

Typ / Type	9 cm – 3½"		11,5 cm – 4½"	
	–	–	OZ-1280-11	OZ-1281-11
MC	–	–	OZ-1280-11M	OZ-1281-11M
CC	–	–	OZ-1280-11C	OZ-1281-11C
TC	OZ-1280-49	OZ-1281-49	OZ-1280-51	OZ-1281-51

MC = SuperCut-Schere / SuperCut scissors
TC = Hartmetallschere / hard metal scissors

CC = Keramikbeschichtete Schere / Ceramic coated scissors
W = Wellenschliff-Schere / Wavecut scissors



Präparierscheren Dissecting Scissors



METZENBAUM-FINO



stumpf / stumpf
blunt / blunt

spitz / spitz
sharp / sharp

gerade
straight

gebogen
curved

gerade
straight

gebogen
curved

Typ / Type	14,5 cm – 5¾"			
	OZ-1290-14	OZ-1291-14	OZ-1292-14	OZ-1293-14
MC	OZ-1290-14M	OZ-1291-14M	–	–
CC	OZ-1290-14C	OZ-1291-14C	–	–
TC	OZ-1306-14	OZ-1316-14	–	OZ-1318-14
TC/MC	OZ-1306-14M	OZ-1316-14M	–	–
TC/CC	OZ-1306-14C	OZ-1316-14C	–	OZ-1318-14C



METZENBAUM



stumpf / stumpf
blunt / blunt

gebogen
curved

gerade
straight

gebogen
curved

Typ / Type	13 cm – 5"	14,5 cm – 5¾"	
	OZ-1311-13	OZ-1301-14	OZ-1311-14
MC	–	OZ-1301-14M	OZ-1311-14M
CC	–	OZ-1301-14C	OZ-1311-14C
TC	–	OZ-1304-14	OZ-314-14
		–	OZ-1314-14RS
TC/MC	–	OZ-1304-14M	OZ-314-14M
TC/CC	–	OZ-1304-14C	OZ-1314-14C
TC/MC/CC	–	–	OZ-1314-14N

MC = SuperCut-Schere / SuperCut scissors
TC = Hartmetallschere / hard metal scissors
RS = gezahnt / serrated

CC = Keramikbeschichtete Schere / Ceramic coated scissors
W = Wellenschliff-Schere / Wavecut scissors

Präparierscheren Dissecting Scissors



METZENBAUM



spitz / stumpf
sharp / blunt

spitz / spitz
sharp / sharp

gerade
straight

gebogen
curved

gerade
straight

gebogen
curved

Typ / Type	14,5 cm – 5¾"			
	OZ-1302-14	OZ-1312-14	OZ-1303-14	OZ-1313-14
TC	–	–	OZ-1308-14	–
TC/CC	–	–	OZ-1308-14C	–

MC = SuperCut-Schere / SuperCut scissors TC
= Hartmetallschere / hard metal scissors

CC = Keramikbeschichtete Schere / Ceramic coated scissors W
= Wellenschliff-Schere / Wavecut scissors



Präparierscheren Dissecting Scissors



METZENBAUM-FINO

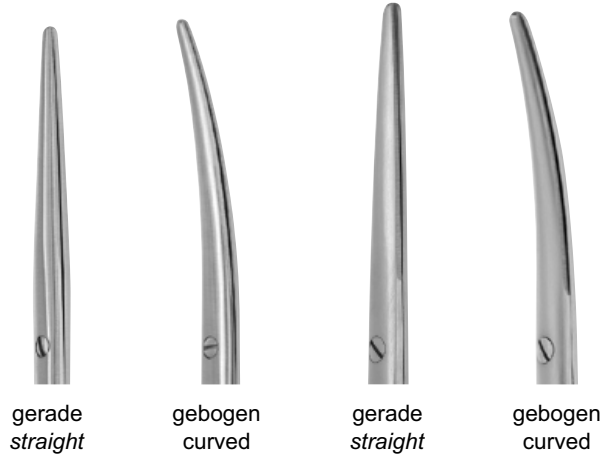

Typ / Type	18 cm – 7"		20 cm – 8"	
	OZ-1320-18	OZ-1330-18	OZ-1320-20	OZ-1330-20
MC	OZ-1320-18M	OZ-1330-18M	–	OZ-1330-20M
CC	OZ-1320-18C	OZ-1330-18C	–	–
TC	OZ-1326-18	OZ-1336-18	OZ-1326-20	OZ-1336-20
TC/MC	OZ-1326-18M	OZ-1336-18M	–	OZ-1336-20M
TC/CC	OZ-1326-18C	OZ-1336-18C	OZ-1326-20C	OZ-1336-20C



METZENBAUM



Typ / Type	18 cm – 7"		20 cm – 8"	
	OZ-1321-18	OZ-1331-18	OZ-1321-20	OZ-1331-20
MC	OZ-1321-18M	OZ-1331-18M	OZ-1321-20M	OZ-1331-20M
CC	OZ-1321-18C	OZ-1331-18C	–	OZ-1331-20C
MC/CC	–	OZ-1331-18N	–	–
TC	OZ-1324-18	OZ-1334-18	OZ-1324-20	OZ-1334-20
TC/MC	OZ-1324-18M	OZ-1334-18M	–	OZ-1334-20M
TC/MC/CC	–	OZ-1334-18N	–	–
TC/CC	OZ-1324-18C	OZ-1334-18C	OZ-1324-20C	OZ-1334-20C
TC/W	–	OZ-1334-18W	–	–

MC = SuperCut-Schere / SuperCut scissors
TC = Hartmetallschere / hard metal scissors

CC = Keramikbeschichtete Schere / Ceramic coated scissors W
= Wellenschliff-Schere / Wavecut scissors



Präparierscheren Dissecting Scissors



METZENBAUM



gebogen
curved

18 cm – 7"

OZ-1331-18S



METZENBAUM-FINO



gerade
straight



gebogen
curved



gerade
straight



gebogen
curved



gebogen
curved

Typ / Type	23 cm – 9"		25 cm – 10"		28 cm – 11"
	OZ-1320-23	OZ-1330-23	OZ-1320-25	OZ-1330-25	OZ-1330-28
MC	–	OZ-1330-23M	–	–	–
CC	OZ-1320-23C	OZ-1330-23C	–	–	–
TC	OZ-1326-23	OZ-1336-23	OZ-1326-25	OZ-1336-25	OZ-1336-28
TC/MC	OZ-1326-23M	OZ-1336-23M	–	OZ-1336-25M	–
TC/CC	OZ-1326-23C	OZ-1336-23C	–	–	–

MC = SuperCut-Schere / *SuperCut scissors* TC
= Hartmetallschere / *hard metal scissors* RS =
gezahnt / *serrated*

CC = Keramikbeschichtete Schere / *Ceramic coated scissors* W
= Wellenschliff-Schere / *Wavecut scissors*
S = Supreme



Präparierscheren Dissecting Scissors

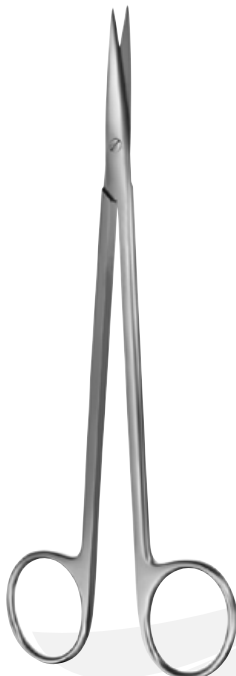

METZENBAUM



spitz / spitz
sharp / sharp

gerade
straight gebogen
curved

18 cm – 7"	OZ-1323-18	OZ-1333-18
20 cm – 8"	OZ-1323-20	OZ-1333-20
23 cm – 9"	OZ-1323-23	OZ-1333-23



METZENBAUM



spitz / spitz
sharp / sharp

	Typ Type	gerade- straight	gebogen- curved
18 cm – 7"	TC	OZ-1328-18	OZ-1338-18
20 cm – 8"	TC	OZ-1328-20	OZ-1338-20
23 cm – 9"	TC	OZ-1328-23	OZ-1338-23

MC = SuperCut-Schere / *SuperCut scissors*
TC = Hartmetallschere / *hard metal scissors*

CC = Keramikbeschichtete Schere / *Ceramic coated scissors* W
= Wellenschliff-Schere / *Wavecut scissors*

Präparierscheren Dissecting Scissors



METZENBAUM



gerade
straight



gebogen
curved



gerade
straight



gebogen
curved

Typ / Type	23 cm – 9"		25 cm – 10"	
	OZ-1321-23	OZ-1331-23	OZ-1321-25	OZ-1331-25
MC	OZ-1321-23M	OZ-1331-23M	–	OZ-1331-25M
CC	OZ-1321-23C	OZ-1331-23C	–	–
TC	OZ-1324-23	OZ-1334-23	–	OZ-1334-25
TC/MC	OZ-1324-23M	OZ-1334-23M	–	–
TC/CC	OZ-1324-23C	OZ-1334-23C	–	–

MC = SuperCut-Schere / *SuperCut scissors* TC
= Hartmetallschere / *hard metal scissors*

CC = Keramikbeschichtete Schere / *Ceramic coated scissors* W
= Wellenschliff-Schere / *Wavecut scissors*



Präparierscheren Dissecting Scissors



METZENBAUM



gerade
straight



gebogen
curved



gerade
straight



curved
gebogen

Typ / Type	28 cm – 11"		30 cm – 11¾"	
	OZ-1321-28	OZ-1331-28	OZ-1321-30	OZ-1331-30
MC	–	OZ-1331-28M	–	OZ-1331-30M
TC	–	OZ-1334-28	–	OZ-1334-30

MC = SuperCut-Schere / *SuperCut scissors*
TC = Hartmetallschere / *hard metal scissors*

CC = Keramikbeschichtete Schere / *Ceramic coated scissors*
W = Wellenschliff-Schere / *Wavecut scissors*



OZZE MEDICAL & SURGICAL SUPPLIES
TOOLS TO OPERATE

Präparierscheren Dissecting Scissors

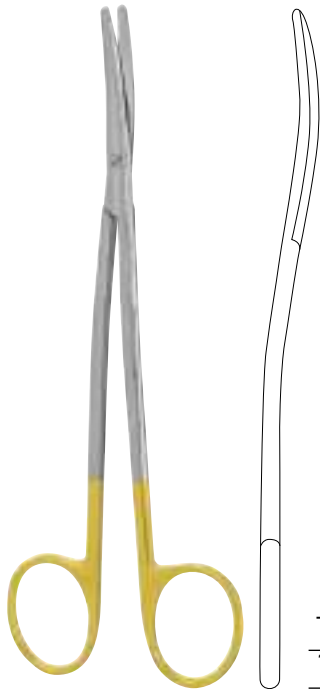

S-gebogen
S-curved

METZENBAUM-S



Typ / Type	14 cm – 5¼"	18 cm – 7"	20 cm – 8"	23 cm – 9"	25 cm – 10"
TC	OZ-1339-15	OZ-1339-18	OZ-1339-20	OZ-339-23	OZ-1339-26

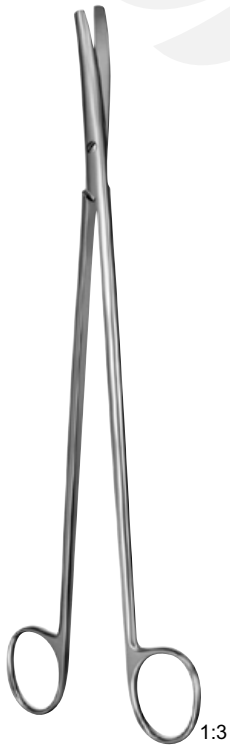

WELLER



gebogen
curved

28 cm – 11"

OZ-1350-28

MC = S uperCut-Schere / SuperCut scissors TC
= Hartmetallschere / hard metal scissors

CC = Keramikbeschichtete Schere / Ceramic coated scissors W
= Wellenschliff-Schere / Wavecut scissors



Facelift- und Nasenscheren Facelift and Nasal Scissors



BABY-LEXER (KNAPP)



gerade
straight



gebogen
curved

10 cm – 4"

OZ-1650-10	OZ-1651-10
-------------------	-------------------



gerade
straight



gebogen
curved

13 cm – 5"

OZ-1654-13	OZ-1655-13
-------------------	-------------------

Facelift- und Nasenscheren Facelift and Nasal Scissors

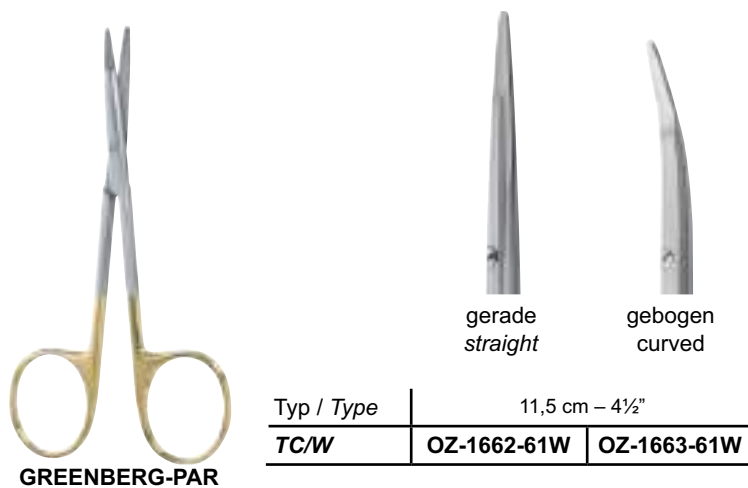

MC = SuperCut-Schere / *SuperCut scissors* TC
= Hartmetallschere / *hard metal scissors*

CC = Keramikbeschichtete Schere / *Ceramic coated scissors* W
= Wellenschliff-Schere / *Wavecut scissors*



Präparierscheren Dissecting Scissors



fein
delicate

PECK-JOSEPH



gerade
straight



gebogen
curved

Typ / Type	14,5 cm – 5¾"	
TC/W	OZ-1666-64W	OZ-1667-64W



JOSEPH



gerade
straight



gebogen
curved

Typ / Type	14 cm – 5½"	
	OZ-1670-14	OZ-1671-14
MC	OZ-1670-14M	OZ-1671-14M
TC	–	OZ-1671-54
TC/MC	–	OZ-1671-54M

MC = SuperCut-Schere / SuperCut scissors TC
= Hartmetallschere / hard metal scissors

CC = Keramikbeschichtete Schere / Ceramic coated scissors W
= Wellenschliff-Schere / Wavecut scissors

Präparierscheren Dissecting Scissors

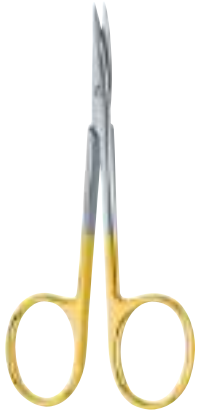

DEVINE

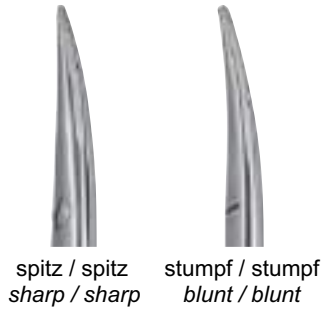

spitz / spitz stumpf / stumpf
sharp / sharp blunt / blunt

gebogen
curved

Typ / Type	11,5 cm – 4½"	
TC	OZ-1673-07	OZ-1673-08



KILNER



gebogen
curved

Typ / Type	12,5 cm – 5"	13,5 cm – 5¼"	15,5 cm – 6"
	OZ-1675-12	OZ-1675-13	OZ-1675-15
MC	OZ-1675-12M	–	–
CC	OZ-1675-12C	–	–
TC	OZ-1675-52	–	–

MC = SuperCut-Schere / SuperCut scissors TC
= Hartmetallschere / hard metal scissors

CC = Keramikbeschichtete Schere / Ceramic coated scissors W
= Wellenschliff-Schere / Wavecut scissors



Präparierscheren Dissecting Scissors



RUDOLF



stumpf / stumpf
blunt / blunt

gerade
straight



stumpf / stumpf
blunt / blunt

gebogen
curved

Typ / Type	11 cm – 4½"	
MC	OZ-1676-01M	OZ-1676-11M
MC/CC	–	OZ-1676-11N
TC	–	OZ-1676-51
TC/MC	–	OZ-1676-51M
TC/W	–	OZ-1676-51W



RUDOLF



stumpf / stumpf
blunt / blunt

gebogen
curved

Typ / Type	14,5 cm – 5¾"	
MC	OZ-1676-14M	
MC/CC	OZ-1676-14N	
TC	OZ-1676-54	
TC/MC	OZ-1676-54M	
TC/W	OZ-1676-54W	



REYNOLDS



gebogen
curved

Typ / Type	13 cm – 5"	
MC	OZ-1677-13M	

MC = SuperCut-Schere / SuperCut scissors TC
= Hartmetallschere / hard metal scissors

CC = Keramikbeschichtete Schere / Ceramic coated scissors W
= Wellenschliff-Schere / Wavecut scissors

Präparierscheren Dissecting Scissors



FREEMAN-KAYE



gerade
straight



gebogen
curved

Typ / Type	18 cm – 7"	
MC	OZ-1680-18M	OZ-1681-18M
MC/CC	OZ-1680-18N	OZ-1681-18N

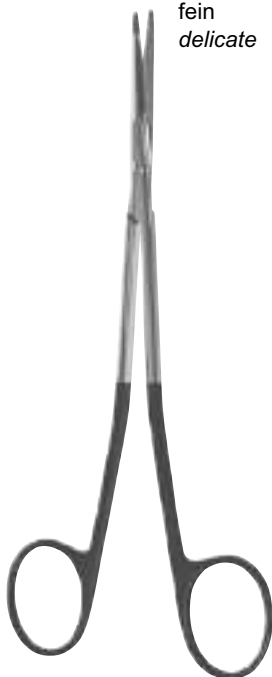

FREEMAN-KAYE



gerade
straight



gebogen
curved

Typ / Type	18 cm – 7"	
MC	OZ-1680-28M	OZ-1681-28M
TC/MC	–	OZ-1681-78M
TC/MC/CC	OZ-1680-78N	OZ-1681-78N
TC/W	–	OZ-1681-78W

MC = SuperCut-Schere / SuperCut scissors TC
= Hartmetallschere / hard metal scissors

CC = Keramikbeschichtete Schere / Ceramic coated scissors W
= Wellenschliff-Schere / Wavecut scissors



Präparierscheren Dissecting Scissors



oberes Blatt
mikrofein gezahnt
*micro serrated
upper blade*
fein
delicate



gebogen
curved

FREEMAN-KAYE

Typ / Type	18 cm – 7"
TC	OZ-1681-78



FREEMAN-GORNEY



gerade
straight



gebogen
curved

Typ / Type	19 cm – 7½"	
MC	OZ-1682-19M	OZ-1683-19M
MC/CC	OZ-1682-19N	OZ-1683-19N
TC/MC	OZ-1682-59M	OZ-1683-59M

MC = SuperCut-Schere / *SuperCut scissors* TC
= Hartmetallschere / *hard metal scissors*

CC = Keramikbeschichtete Schere / *Ceramic coated scissors* W
= Wellenschliff-Schere / *Wavecut scissors*



Präparierscheren Dissecting Scissors



KAYE



gebogen
curved

Typ / Type	15 cm – 6"	19 cm – 7½"
MC	OZ-1685-15M	OZ-1685-19M
MC/CC	OZ-1685-15N	–
TC/MC	OZ-1685-55M	OZ-1685-59M
TC/MC/CC	OZ-1685-55N	–
TC/W	OZ-1685-55W	OZ-1685-59W
gezahntsaw edge	OZ-1685-15	–



KAYE-FACELIFT

fein
delicate



gebogen
curved

Typ / Type	15 cm – 6"	18 cm – 7"
TC/MC/CC	OZ-1679-54N	OZ-1679-58N
TC/W	OZ-1679-54W	OZ-1679-58W

MC = SuperCut-Schere / SuperCut scissors
TC = Hartmetallschere / hard metal scissors

CC = Keramikbeschichtete Schere / Ceramic coated scissors
W = Wellenschliff-Schere / Wavecut scissors



Präparierscheren Dissecting Scissors



CASTANARES



gerade
straight

Typ / Type	16 cm – 6¼"
MC	OZ-1687-16M
TC/MC	OZ-1687-56M
TC/W	OZ-1687-56W



GORNEY



gerade
straight



gebogen
curved

Typ / Type	12 cm – 4¾"	
MC	OZ-1688-12M	OZ-1689-12M

MC = SuperCut-Schere / SuperCut scissors TC
= Hartmetallschere / hard metal scissors

CC = Keramikbeschichtete Schere / Ceramic coated scissors W
= Wellenschliff-Schere / Wavecut scissors

Präparierscheren Dissecting Scissors



GORNEY



gerade
straight



gebogen
curved

Typ / Type	18,5 cm – 7¼"	
MC	OZ-1688-19M	OZ-1689-19M
MC/CC	OZ-1688-19N	OZ-1689-19N
TC/MC	OZ-1688-59M	OZ-1689-59M



GORNEY

fein
delicate



gerade
straight



gebogen
curved

Typ / Type	19 cm – 7½"	
MC	OZ-1688-29M	OZ-1689-29M
TC	–	OZ-1689-79
TC/MC	OZ-1688-79M	OZ-1689-79M
TC/MC/CC	OZ-1688-79N	OZ-1689-79N
TC/W	OZ-1688-79W	OZ-1689-79W

MC = SuperCut-Schere / SuperCut scissors
TC = Hartmetallschere / hard metal scissors

CC = Keramikbeschichtete Schere / Ceramic coated scissors
W = Wellenschliff-Schere / Wavecut scissors



Präparierscheren Dissecting Scissors



GORNEY



gerade
straight



gebogen
curved

Typ / Type	23 cm – 9"	
MC	OZ-1690-23M	OZ-1691-23M
TC/MC	OZ-1690-53M	OZ-1691-53M
TC/W	OZ-1690-53W	OZ-1691-53W



FREEMAN



gerade
straight

Typ / Type	18 cm – 7"
MC	OZ-1693-18M
TC/MC	OZ-1693-58M
TC/W	OZ-1693-58W

MC = SuperCut-Schere / *SuperCut scissors* TC
= Hartmetallschere / *hard metal scissors*

CC = Keramikbeschichtete Schere / *Ceramic coated scissors* W
= Wellenschliff-Schere / *Wavecut scissors*



Präparierscheren Dissecting Scissors

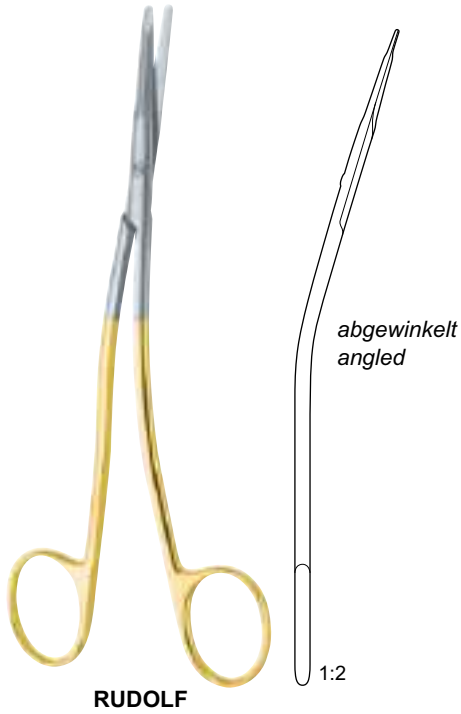

gerade
straight



aufgebogen
curved up



abwärts gebogen
curved down

Typ / Type	18 cm – 7"	18 cm – 7"	18 cm – 7"
TC/MC	OZ-1695-00M	OZ-1695-01M	OZ-1695-10M
TC/MC/CC	OZ-1695-00N	OZ-1695-01N	OZ-1695-10N

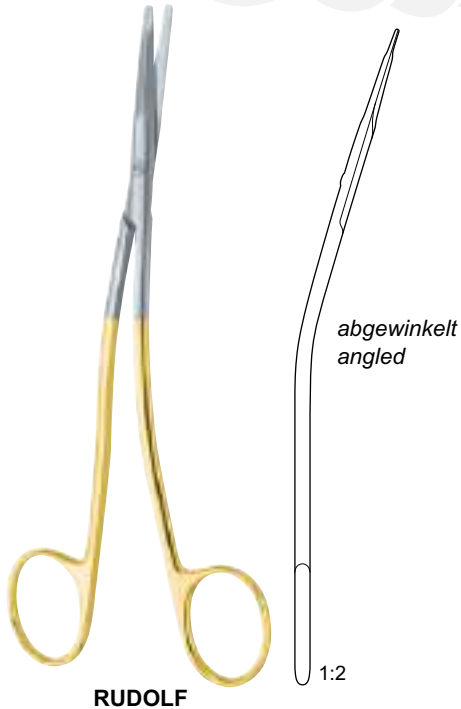

gerade
straight



aufgebogen
curved up



abwärts gebogen
curved down

Typ / Type	23 cm – 9"	23 cm – 9"	23 cm – 9"
TC/MC	OZ-1695-02M	OZ-1695-03M	OZ-1695-11M
TC/MC/CC	OZ-1695-02N	OZ-1695-03N	OZ-1695-11N

MC = SuperCut-Schere / SuperCut scissors
TC = Hartmetallschere / hard metal scissors

CC = Keramikbeschichtete Schere / Ceramic coated scissors
W = Wellenschliff-Schere / Wavecut scissors



Nasenscheren Nasal Scissors



HEYMANN

seitlich gewinkelt
angled to side

Typ / Type	18 cm – 7"
	OZ-2115-18
MC	OZ-2115-18M
TC	OZ-2115-58



HEYMANN

seitlich gewinkelt
angled to side

	19,5 cm – 7¾"
	OZ-2116-19



gezahnt
serrated edge

seitlich gewinkelt
angled to side

	19 cm – 7½"
	OZ-2117-18

MC = SuperCut-Schere / SuperCut scissors
TC = Hartmetallschere / hard metal scissors

CC = Keramikbeschichtete Schere / Ceramic coated scissors
W = Wellenschliff-Schere / Wavecut scissors



Nasenscheren Nasal Scissors



COTTLE-MASING

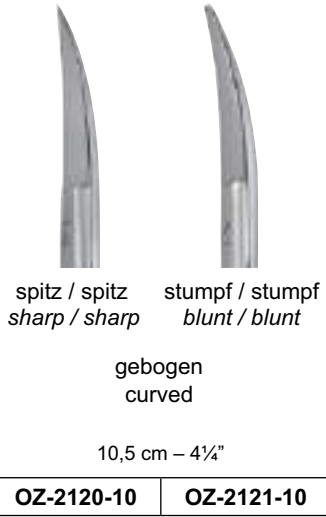

KILNER



FOMON-SABER-BACK

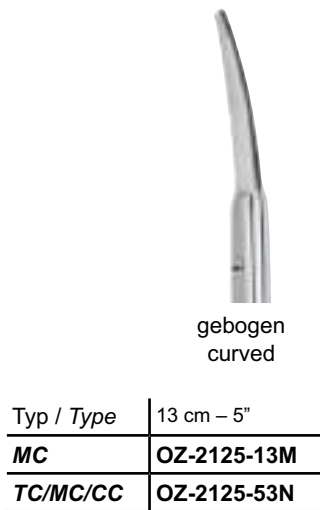

FOMON

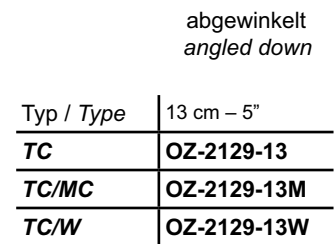

MC = SuperCut-Schere / SuperCut scissors TC
= Hartmetallschere / hard metal scissors

CC = Keramikbeschichtete Schere / Ceramic coated scissors W
= Wellenschliff-Schere / Wavecut scissors



Nasenscheren Nasal Scissors

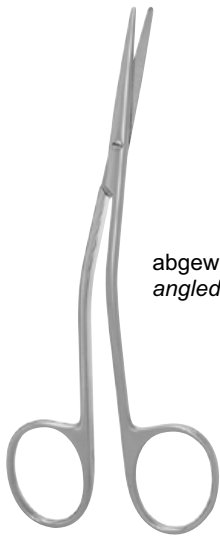

abgewinkelt
angled down

FOMON

Typ / Type	13 cm – 5"
	OZ-2130-13
MC	OZ-2130-13M



schlankes Modell
slender pattern

abgewinkelt
angled down

FOMON

Typ / Type	13,5 cm – 5¼"
	OZ-2131-13
MC	OZ-2131-13M



FOMON

Typ / Type	13,5 cm – 5¼"
	OZ-2132-13
MC	OZ-2132-13M



gebogen
curved



abgewinkelt
angled down

COTTLE

Typ / Type	16 cm – 6¼"
	OZ-2135-16
MC	OZ-2135-16M

MC = SuperCut-Schere / SuperCut scissors TC
= Hartmetallschere / hard metal scissors

CC = Keramikbeschichtete Schere / Ceramic coated scissors W
= Wellenschliff-Schere / Wavecut scissors

Nasenscheren Nasal Scissors



abgewinkelt
angled down

COTTLE

Typ / Type	16 cm – 6¼"
TC	OZ-2136-16
TC/MC	OZ-2136-16M
TC/W	OZ-2136-16W

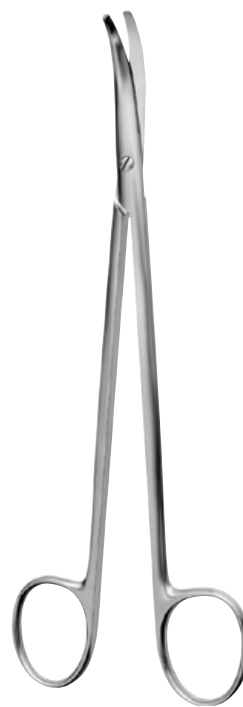

gebogen
curved

19 cm – 7½"
OZ-2140-19

HALLE



MC = SuperCut-Schere / SuperCut scissors
= Hartmetallschere / hard metal scissors

CC = Keramikbeschichtete Schere / Ceramic coated scissors
= Wellenschliff-Schere / Wavecut scissors



Gefäßscheren Vascular Scissors

Gefäßschere
mit Knopf
*Vascular scissors
probe-pointed*



Speichelgangschere
mit Knopf
*Salivary duct scissors
probe-pointed*



spitz / spitz
sharp / sharp



spitz / stumpf
sharp / blunt



stumpf / stumpf
blunt / blunt

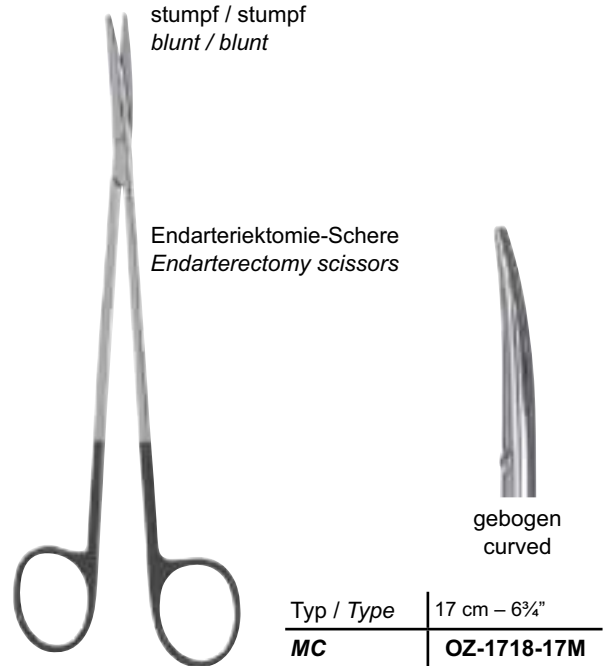

MC = SuperCut-Schere / *SuperCut scissors TC*
= Hartmetallschere / *hard metal scissors*

CC = Keramikbeschichtete Schere / *Ceramic coated scissors W*
= Wellenschliff-Schere / *Wavecut scissors*



Gefäßscheren Vascular Scissors



1:3

MARTIN-CARTILAGE



Knorpelschere
Cartilage scissors
stumpf / stumpf
blunt / blunt

gebogen, gezahnt
curved, serrated edge

20 cm – 8"

OZ-1725-19

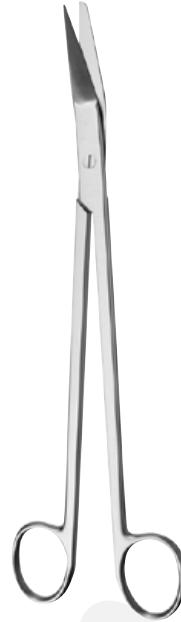

1:3

RESANO



Kapselschere *Cap-
sule scissors*

gewinkelt
angled

25 cm – 10"

OZ-1726-25



1:3

MC INDOE



gerade
straight

19 cm – 7½"

OZ-1730-19

MC = SuperCut-Schere / *SuperCut scissors* TC
= Hartmetallschere / *hard metal scissors*

CC = Keramikbeschichtete Schere / *Ceramic coated scissors* W
= Wellenschliff-Schere / *Wavecut scissors*



OZZE MEDICAL & SURGICAL SUPPLIES
TOOLS TO OPERATE

Gefäßscheren Vascular Scissors



POTTS-SMITH



gebogen
curved

19 cm – 7½"

OZ-1735-19



JORGENSEN



gebogen
curved

Typ / Type	22 cm – 8¾"
	OZ-1739-22
MC	OZ-1739-22M

MC = SuperCut-Schere / *SuperCut scissors* TC
= Hartmetallschere / *hard metal scissors*

CC = Keramikbeschichtete Schere / *Ceramic coated scissors* W
= Wellenschliff-Schere / *Wavecut scissors*



OZZE MEDICAL & SURGICAL SUPPLIES
TOOLS TO OPERATE

Gefäßscheren Vascular Scissors

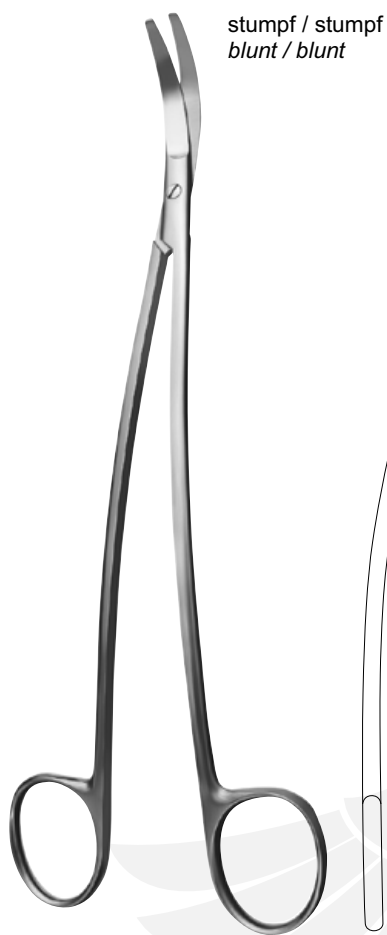

stumpf / stumpf
blunt / blunt

S-gebogen
S-curved

24,5 cm – 9¾"
OZ-1740-24

SATINSKY

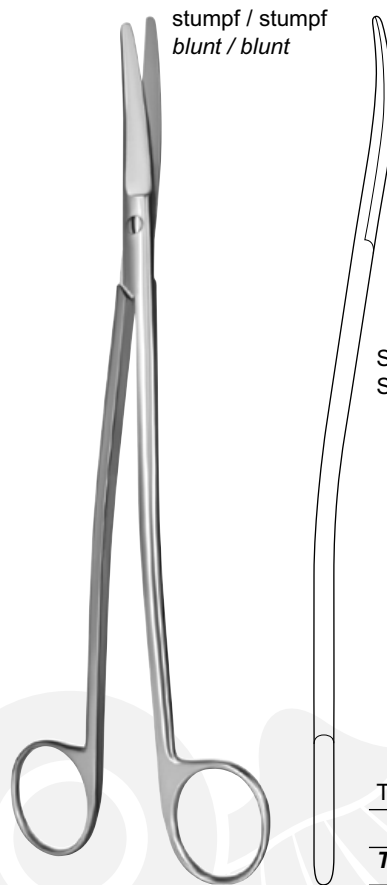

stumpf / stumpf
blunt / blunt

S-gebogen
S-curved

Typ / Type	22 cm – 8¾"
	OZ-1745-23
TC	OZ-1744-23

KLINGENBERG-LOTH

MC = S uperCut-Schere / SuperCut scissors TC
= Hartmetallschere / hard metal scissors

CC = Keramikbeschichtete Schere / Ceramic coated scissors W
= Wellenschliff-Schere / Wavecut scissors



Gefäßscheren Vascular Scissors



POTTS-SMITH

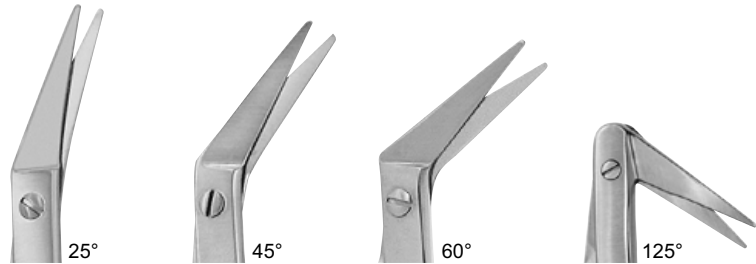

Typ / Type	gewinkelt angled			
	18,5 cm – 7¼"		18 cm – 7"	
	OZ-1720-19	OZ-1721-19	OZ-1722-19	OZ-1723-19
MC	OZ-1720-19M	OZ-1721-19M	OZ-1722-19M	–
CC	OZ-1720-19C	OZ-1721-19C	OZ-1722-19C	–
MC/CC	OZ-1720-19N	OZ-1721-19N	OZ-1722-19N	–
TC	OZ-1724-25	OZ-1724-45	OZ-1724-60	–

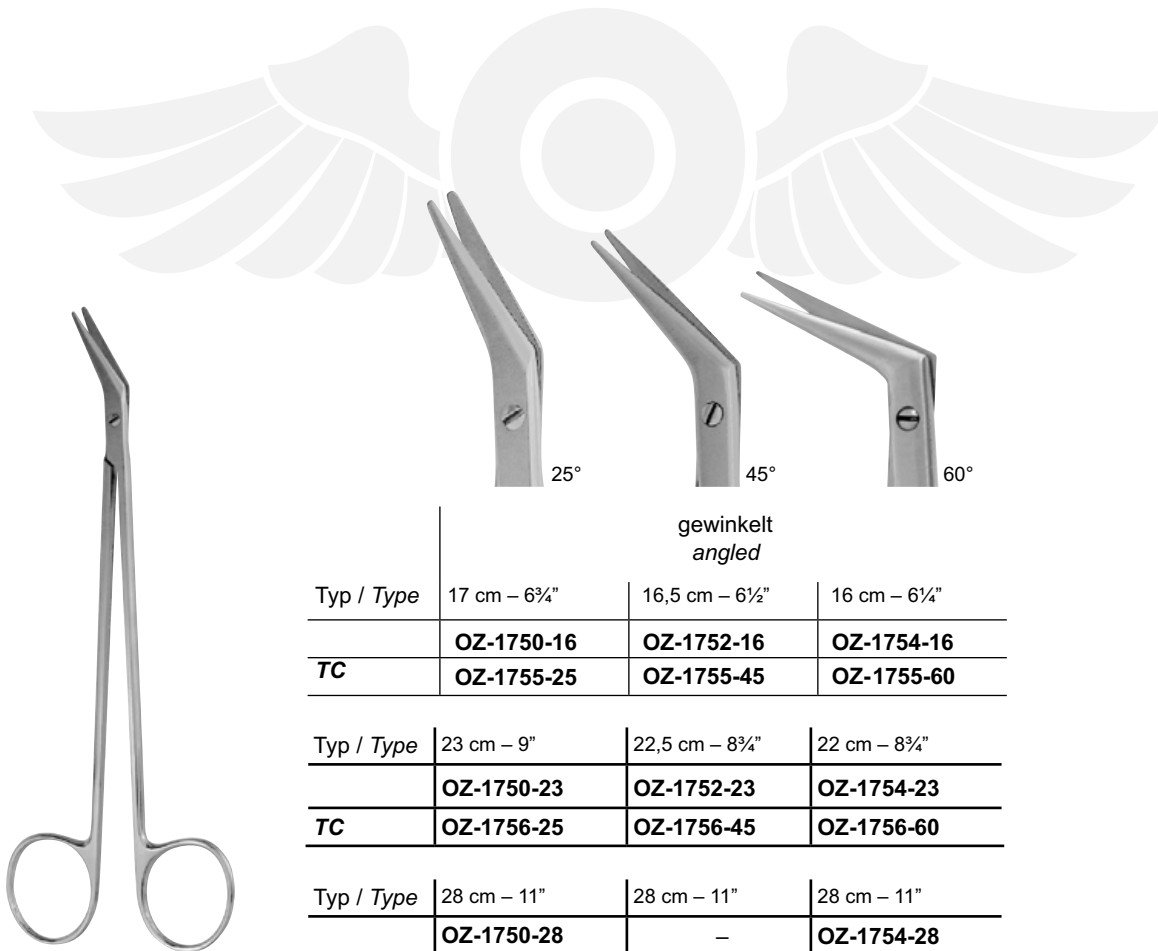

DE BAKEY

Typ / Type	gewinkelt angled		
	17 cm – 6¾"	16,5 cm – 6½"	16 cm – 6¼"
	OZ-1750-16	OZ-1752-16	OZ-1754-16
TC	OZ-1755-25	OZ-1755-45	OZ-1755-60
	OZ-1750-23	OZ-1752-23	OZ-1754-23
TC	OZ-1756-25	OZ-1756-45	OZ-1756-60
	OZ-1750-28	–	OZ-1754-28

MC = SuperCut-Schere / SuperCut scissors
TC = Hartmetallschere / hard metal scissors

CC = Keramikbeschichtete Schere / Ceramic coated scissors W
= Wellenschliff-Schere / Wavecut scissors

Gefäßscheren Vascular Scissors



HEGEMANN-DIETHRICH

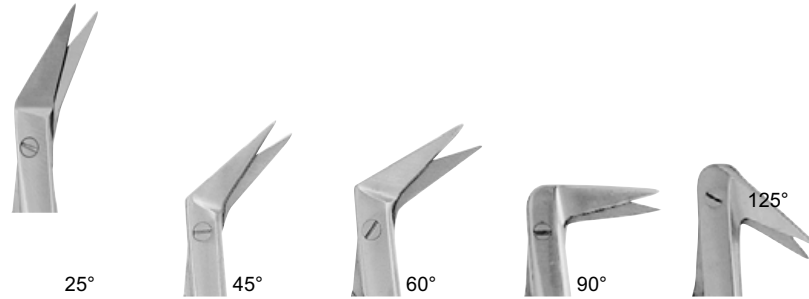

		gewinkelt <i>angled</i>				
Typ / Type		13,5 cm – 5¼"		13 cm – 5"	13,5 cm – 5¼"	–
		OZ-1760-13	OZ-1761-13	OZ-1762-13	OZ-1763-13	–
		15,5 cm – 6"		14,5 cm – 5¾"	14 cm – 5½"	
		OZ-1760-16	OZ-1761-16	OZ-1762-16	OZ-1763-16	OZ-1764-16
		18 cm – 7"		17,5 cm – 7"	17 cm – 6¾"	
		OZ-1760-19	OZ-1761-19	OZ-1762-19	OZ-1763-19	OZ-1764-19
MC		OZ-1760-19M	OZ-1761-19M	OZ-1762-19M	OZ-1763-19M	OZ-1764-19M
MC/CC		–	OZ-1761-19N	–	–	–

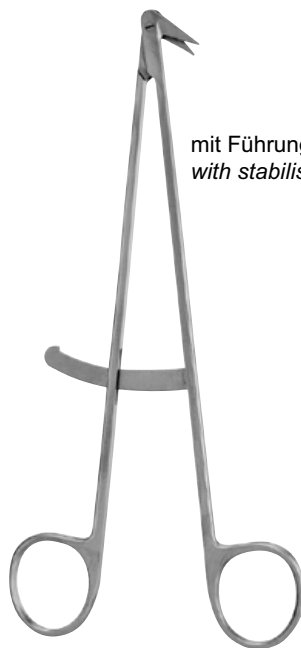

HEGEMANN-DIETHRICH

mit Führungsschiene
with stabilising bar



		gewinkelt <i>angled</i>
Typ / Type		17 cm 6¾"
		OZ-1765-19
MC		OZ-1765-19M

MC = SuperCut-Schere / *SuperCut scissors* TC
= Hartmetallschere / *hard metal scissors*

CC = Keramikbeschichtete Schere / *Ceramic coated scissors* W
= Wellenschliff-Schere / *Wavecut scissors*



Gefäßscheren Vascular Scissors



STREAMLINE

durch den geschwungenen Schluss verfängt sich der Faden nicht mehr, sondern gleitet über die Oberfläche.

weniger Reparatur anfällig

because of the curved lock design the suture does not get caught and slides over the surface.

less prone to repairs

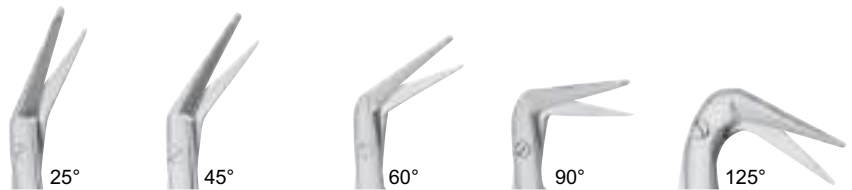

Schneide mit Knopf, spitz, gewinkelt
Blade with button, sharp, angled

Typ / Type	17,5 cm – 7"		17 cm – 6¾"	16,5 cm – 6½"	
	OZ-1770-25	OZ-1770-45	OZ-1770-60	OZ-1770-90	OZ-1770-99

Typ / Type	18 cm – 7"				
TI	OZ-1770-25V	OZ-1770-45V	OZ-1770-60V	OZ-1770-90V	OZ-1770-99V
STREAMLINE	OZ-1770-25R	OZ-1770-45R	OZ-1770-60R	OZ-1770-90R	OZ-1770-99R

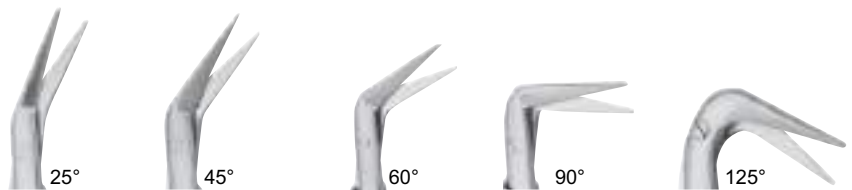

Schneide ohne Knopf, spitz, gewinkelt
Blade without button, sharp, angled

Titanium

Typ / Type	17,5 cm – 7"		17 cm – 6¾"	16,5 cm – 6½"	
	OZ-1771-25	OZ-1771-45	OZ-1771-60	OZ-1771-90	OZ-1771-99
TI	OZ-1771-25T	OZ-1771-45T	OZ-1771-60T	OZ-1771-90T	OZ-1771-99T

Typ / Type	18 cm – 7"				
TI	OZ-1771-25V	OZ-1771-45V	OZ-1771-60V	OZ-1771-90V	OZ-1771-99V
STREAMLINE	OZ-1771-25R	OZ-1771-45R	OZ-1771-60R	OZ-1771-90R	OZ-1771-99R

TI = Titan /

V = Titan / Titanium / STREAMLINE

Gefäßscheren Vascular Scissors



STREAMLINE

durch den geschwungenen Schluss verfängt sich der Faden nicht mehr, sondern gleitet über die Oberfläche.

weniger Reparatur anfällig

because of the curved lock design the suture does not get caught and slides over the surface.

less prone to repairs



Schneide mit Knopf, spitz, gewinkelt
Blade with button, sharp, angled

	17,5 cm – 7"	17 cm – 6¾"	16,5 cm – 6½"	
	OZ-1772-25	OZ-1772-45	OZ-1772-60	OZ-1772-90
	OZ-1772-99			

	OZ-1772-25R	OZ-1772-45R	OZ-1772-60R	OZ-1772-90R	OZ-1772-99R
STREAMLINE					



Schneide ohne Knopf, spitz, gewinkelt
Blade without button, sharp, angled

	17,5 cm – 7"	17 cm – 6¾"	16,5 cm – 6½"	
	OZ-1773-25	OZ-1773-45	OZ-1773-60	OZ-1773-90
	OZ-1773-99			

	OZ-1773-25R	OZ-1773-45R	OZ-1773-60R	OZ-1773-90R	OZ-1773-99R
STREAMLINE					



OZZE MEDICAL & SURGICAL SUPPLIES
TOOLS TO OPERATE

Neurochirurgische Scheren Neurosurgical Scissors



45° gewinkelt
45° angled

21 cm – 8¼"

OZ-2490-21

POTTS-DE MARTEL



45° gewinkelt,
geknöpft 45°
angled, probe
pointed

21 cm – 8¼"

OZ-2491-21

MILLS



Duraschere
Dura scissors

60° gewinkelt,
geknöpft 60°
angled, probe
pointed

14,5 cm – 5¾"

OZ-2495-14

SCHMIEDEN-TAYLOR

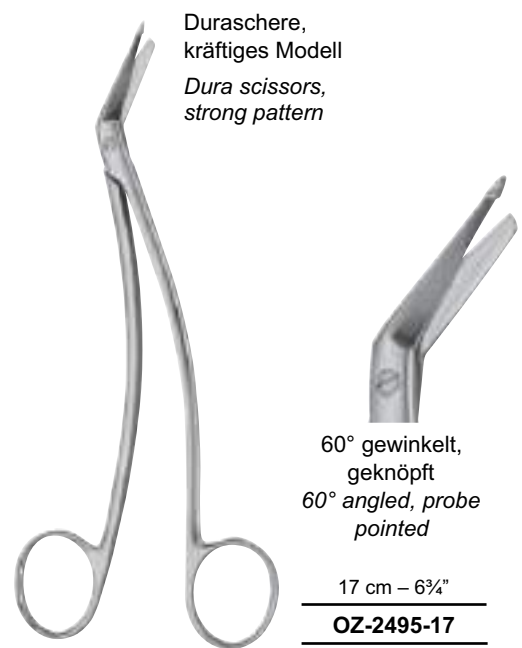

Duraschere,
kräftiges Modell
Dura scissors,
strong pattern

60° gewinkelt,
geknöpft
60° angled, probe
pointed

17 cm – 6¾"

OZ-2495-17

SCHMIEDEN-TAYLOR



OZZE MEDICAL & SURGICAL SUPPLIES
TOOLS TO OPERATE

Neurochirurgische Scheren Neurosurgical Scissors



STRULLY



spitz, gebogen
sharp, curved



geknöpft, gebogen
probe pointed, curved

22 cm – 8¾"

OZ-2496-22

OZ-2497-22



Nerv-Präparierschere
Nerve dissecting scissors



gebogen
curved

15,5 cm – 6"

OZ-1792-15



Tonsillen-Scheren Tonsil Scissors

Arteriotomie Schere
Arteriotomy scissors



TÖNNIS-ADSON FINO



gebogen
curved

17,5 cm – 7"

OZ-1819-17



TÖNNIS



gerade
straight

OZ-1820-18



gebogen
curved

OZ-1821-18



gerade,
sehr fein
straight,
very delicate

18 cm – 7"

OZ-1822-18

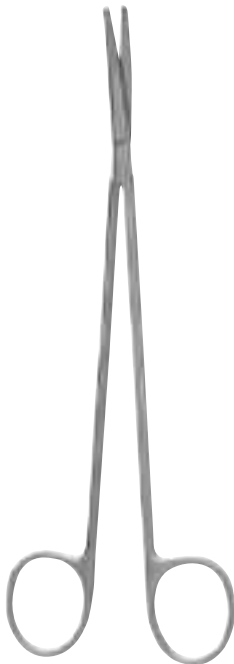

TÖNNIS-ADSON



gebogen
curved

Typ / Type	17,5 cm – 7"
	OZ-1825-17
MC	OZ-1825-17M
CC	OZ-1825-17C
TC	OZ-1829-17
TC/CC	OZ-1829-17C
TC/W	OZ-1829-17W

MC = SuperCut-Schere / SuperCut scissors TC
= Hartmetallschere / hard metal scissors

CC = Keramikbeschichtete Schere / Ceramic coated scissors W
= Wellenschliff-Schere / Wavecut scissors



Tonsillen-Scheren Tonsil Scissors



BÖTTCHER



gebogen
curved

18 cm – 7"

OZ-1810-18



BÖTTCHER



gebogen
curved

18 cm – 7"

OZ-1811-18



GOOD



gebogen
curved

19 cm – 7½"

OZ-1845-19

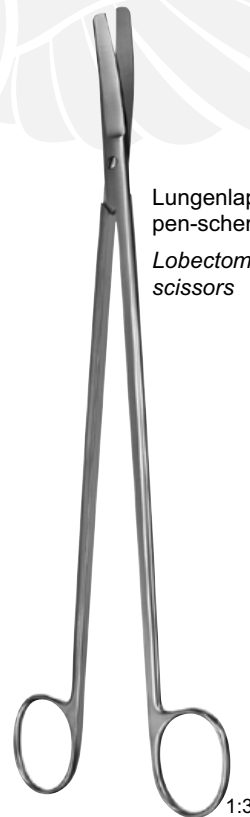

CRAFOORD



gebogen
curved

30 cm – 11¼"

OZ-1860-30

MC = SuperCut-Schere / SuperCut scissors TC
= Hartmetallschere / hard metal scissors

CC = Keramikbeschichtete Schere / Ceramic coated scissors W
= Wellenschliff-Schere / Wavecut scissors

Darmscheren Enterotomy Scissors





Ligaturscheren Ligature Scissors



SPENCER

-	gerade <i>straight</i>
9 cm – 3½"	OZ-2510-09
10,5 cm – 4¼"	OZ-2510-10
12 cm – 4¾"	OZ-2510-12



SPENCER-FINO

-	gerade <i>straight</i>
11 cm – 4¼"	OZ-2512-11
16 cm – 6¼"	OZ-2514-16



LITTAUER

gerade <i>straight</i>
14 cm – 5½"
OZ-2500-14



SHORTBENT

gebogen <i>curved</i>
9 cm – 3½"
OZ-2520-09



NORTHBENT

gebogen <i>curved</i>
12,5 cm – 5"
OZ-2520-12



gewinkelt <i>angled</i>	
Typ / Type	12,5 cm – 5"
	OZ-2522-11
CC	OZ-2522-11C

MC = SuperCut-Schere / *SuperCut scissors* TC
= Hartmetallschere / *hard metal scissors*

CC = Keramikbeschichtete Schere / *Ceramic coated scissors* W
= Wellenschliff-Schere / *Wavecut scissors*



Ligaturscheren Ligature Scissors

Speziell zum Schneiden von Nahtmaterial:

Schneiden mit aufgeschweißtem Hartmetall für erhöhte Standzeit

fein gezahntes Blatt verhindert ein Herausrutschen des Nahtmaterials

weit auslaufender Schluss verhindert ein Einklemmen oder Verfangen des Nahtmaterials weit herausgestellte Griffenden für optimierte Handhabung

Especially for the cutting of suture material:

blades with welded hard metal for extended lifetime fine serrated blade prevents the slipping of suture material

smoothly widening lock design prevents the suture material from getting caught in the parts of scissors exposed handles for optimized handling



gebogen
curved

Typ / Type	14,5 cm – 5¾"	18 cm – 7"	23 cm – 9"	26 cm – 10¼"
TC	OZ-1314-14RS	OZ-1334-18RS	OZ-1334-23RS	OZ-1334-26RS



gerade
straight

10 cm – 4"

OZ-2535-10



Präparierschere mit Fadenbohrung

Dissecting scissors with suture holes



gebogen
curved

11,5 cm – 4½"

OZ-2526-11

LITTLER



12,5 cm – 5"

OZ-2548-12

SCHOEMAKER-LOTH

Gynäkologische Scheren Gynecological Scissors



stumpf / stumpf
blunt / blunt

spitz / stumpf
sharp / blunt

	Typ Type	gerade- straight	gebogen- curved	gerade- straight	gebogen- curved
20 cm – 8"		OZ-1401-20	OZ-1411-20	OZ-1402-20	OZ-1412-20
	MC	OZ-1401-20M	OZ-1411-20M	–	–
23 cm – 9"		OZ-1401-23	OZ-1411-23	OZ-1402-23	OZ-1412-23
	MC	–	OZ-1411-23M	–	–



stumpf / stumpf
blunt / blunt

	Typ Type	gebogen- curved
20 cm – 8"	MC	OZ-1414-20M
	TC	OZ-1414-20
23 cm – 9"	MC	OZ-1414-23M
	TC	OZ-1414-23

MC = SuperCut-Schere / SuperCut scissors TC
= Hartmetallschere / hard metal scissors

CC = Keramikbeschichtete Schere / Ceramic coated scissors W
= Wellenschliff-Schere / Wavecut scissors



Gynäkologische Scheren Gynecological Scissors

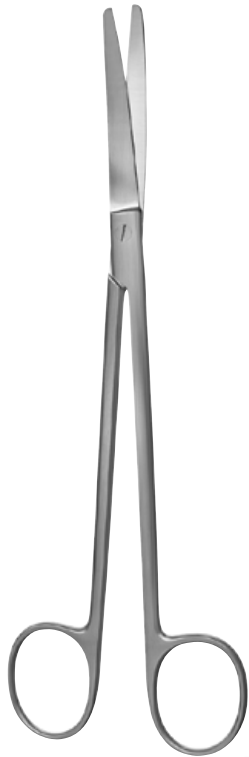

WERTHEIM



-	gebogen curved
14,5 cm – 5¾"	OZ-1415-14
19,5 cm – 7¾"	OZ-1415-19
22,5 cm – 8¾"	OZ-1415-22



DUBOIS

1:3

Kephalotomie-Schere
Cephalotomy scissors



gerade
straight



gebogen
curved

27 cm – 10½"

OZ-1420-27	OZ-1421-27
-------------------	-------------------



Gynäkologische Scheren Gynecological Scissors



DOYEN



spitz / stumpf
sharp / blunt

stumpf / stumpf
blunt / blunt

gerade
straight

gerade
straight

gebogen
curved

16 cm – 6¼"	OZ-1428-16	OZ-1430-16	OZ-1431-16
18 cm – 7"	–	OZ-1430-18	OZ-1431-18

Fistelschere
Fistula scissors

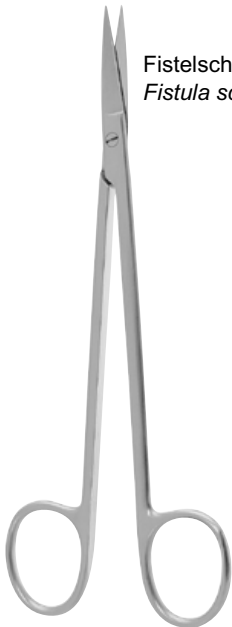

KELLY



gerade
straight

gebogen
curved

gerade
straight

gebogen
curved

Typ / Type	16 cm – 6¼"		18 cm – 7"	
	OZ-1440-16	OZ-441-16	OZ-1440-18	OZ-1441-18
MC	OZ-1440-16M	OZ-1441-16M	–	–
CC	–	OZ-1441-16C	–	–
TC	OZ-1444-16	OZ-1445-16	–	–
TC/MC	OZ-1444-16M	OZ-1445-16M	–	–

MC = SuperCut-Schere / SuperCut scissors
TC = Hartmetallschere / hard metal scissors

CC = Keramikbeschichtete Schere / Ceramic coated scissors
W = Wellenschliff-Schere / Wavecut scissors

Gynäkologische Scheren Gynecological Scissors

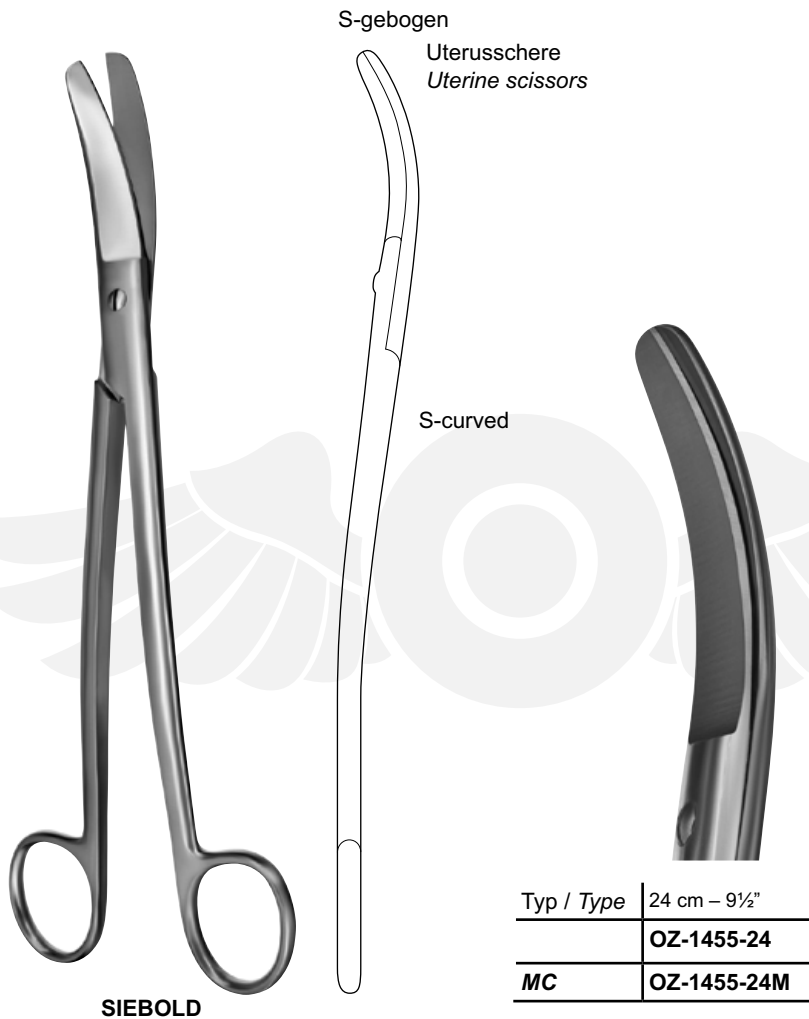

MC = S uperCut-Schere / *SuperCut scissors*
 TC = Hartmetallschere / *hard metal scissors*

CC = Keramikbeschichtete Schere / *Ceramic coated scissors* W
 = Wellenschliff-Schere / *Wavecut scissors*



OZZE MEDICAL & SURGICAL SUPPLIES
TOOLS TO OPERATE

Nabelschnurscheren Umbilical Scissors



BUSCH



gebogen
curved

16 cm – 6¼"

OZ-2000-16



SCHUMACHER

16 cm – 6¼"

OZ-2010-16



**MODELL USA
USA PATTERN**

10,5 cm – 4¼"

OZ-2020-10



Damm-(Episiotomie-)Scheren **OZZE MEDICAL & SURGICAL SUPPLIES** Perineum (Episiotomy) Scissors **TOOLS TO OPERATE**



BRAUN-STADLER

Typ / Type	14 cm – 5½"	22 cm – 8¾"
	OZ-2050-14	OZ-2055-22
MC	OZ-2050-14M	OZ-2055-22M



seitwärts gewinkelt
angled to side



WALDMANN



	ser-	gezahnt rated
Typ / Type	18 cm – 7"	
	OZ-2085-18	
MC	OZ-2085-18M	
CC	OZ-2085-18C	
MC/CC	OZ-2085-18N	



		gezahnt serrated
Typ / Type	19 cm – 7½"	
	OZ-2086-19	
MC	OZ-2086-19M	



gezahnt
serrated



		gezahnt serrated
Typ / Type	19 cm – 7½"	
TC	OZ-2087-19	
TC/MC	OZ-2087-19M	
TC/CC	OZ-2087-19C	



gezahnt
serrated

MC = SuperCut-Schere / SuperCut scissors
 TC = Hartmetallschere / hard metal scissors

CC = Keramikbeschichtete Schere / Ceramic coated scissors W
 = Wellenschliff-Schere / Wavecut scissors

Parametriumscheren Parametrium Scissors



gebogen
 curved

Fig. 1

Fig. 2

Fig. 3

Tc	23 cm – 9"	OZ-2090-11	OZ-2090-12	OZ-2090-13	OZ-2090-14
TC	26,5 cm – 10½"	OZ-2090-21	OZ-2090-22	OZ-2090-23	OZ-2090-24
Tc	30 cm – 11¾"	OZ-2090-31	OZ-2090-32	OZ-2090-33	OZ-2090-34



gebogen
 curved

MC	27,5 cm – 10¾"	OZ-2091-01M	OZ-2091-02M	OZ-2091-03M
-----------	----------------	--------------------	--------------------	--------------------

MC = SuperCut-Schere / *SuperCut scissors*
 TC = Hartmetallschere / *hard metal scissors*

CC = Keramikbeschichtete Schere / *Ceramic coated scissors* W
 = Wellenschliff-Schere / *Wavecut scissors*



Kronenscheren Crown Scissors



BEEBEE



spitz / spitz
gerade

sharp / sharp
straight



spitz / spitz
gebogen

sharp / sharp
curved

10,5 cm – 4¼"

OZ-2870-10	OZ-2871-10
-------------------	-------------------



BEEBEE



stumpf / stumpf
gerade, gezahnt

blunt / blunt
straight, serrated



stumpf / stumpf
gebogen, gezahnt

blunt / blunt
curved, serrated

12 cm – 4¾"

OZ-2890-12	OZ-2891-12
-------------------	-------------------



OZZE MEDICAL & SURGICAL SUPPLIES
TOOLS TO OPERATE

Zahnfleischscheren Gum Scissors



DEAN



gewinkelt, gezahnt
angled, serrated

17 cm – 6¾"

OZ-2913-17



LOCKLIN



gewinkelt, gezahnt
angled, serrated

16,5 cm – 6½"

OZ-2918-16



SULLIVAN



gezahnt
serrated

gerade
straight

gebogen
curved

14,5 cm – 5¾"

OZ-2920-14

OZ-2921-14



Zahnfleischscheren Gum Scissors

LA GRANGE

S-gebogen
S-curved

gezahnt
serrated

gebogen
curved

gerade
straight

gebogen
curved

Typ / Type	11,5 cm – 4½"
	OZ- 2932-11
MC/CC	OZ-2932-11N
TC	OZ-2933-11

OZ-2940-11	OZ-2941-11
-------------------	-------------------





MC = S uperCut-Schere / SuperCut scissors TC
= Hartmetallschere / hard metal scissors

CC = Keramikbeschichtete Schere / Ceramic coated scissors W
= Wellenschliff-Schere / Wavecut scissors



Nagelscheren Nail Scissors



	
gerade straight	gebogen curved
10,5 cm – 4¼"	
OZ-2980-10	OZ-2981-10



	gebogen curved
-	
9 cm – 3½"	OZ-2983-09
10,5 cm – 4¼"	OZ-2983-10



	straight	
Typ / Type	13 cm – 5"	15 cm – 6"
	OZ-2620-13	OZ-2620-15
W	-	OZ-2620-15W

MC = SuperCut-Schere / SuperCut scissors
TC = Hartmetallschere / hard metal scissors

CC = Keramikbeschichtete Schere / Ceramic coated scissors
W = Wellenschliff-Schere / Wavecut scissors



Draht-, Blechscheren Wire, Metal Cutting Scissors



Drahtschere
Wire cutting scissors



seitwärts gewinkelt
angled to side

Typ / Type	12,5 cm – 5"
	OZ-2600-12
TC	OZ-2601-12



Draht- und
Blechtschere
Wire and metal
cutting scissors



seitwärts gewinkelt
angled to side

Typ / Type	16,5 cm – 6½"
TC	OZ-2603-16

MC = S uperCut-Schere / *SuperCut scissors TC*
= Hartmetallschere / *hard metal scissors*

CC = Keramikbeschichtete Schere / *Ceramic coated scissors W*
= Wellenschliff-Schere / *Wavecut scissors*



Verbandscheren Bandage Scissors



	seitwärts gewinkelt <i>gled to side</i>
	14,5 cm – 5¾"
schwarz- black	OZ-2602-14



	seitwärts gewinkelt <i>gled to side</i>
	16 cm – 6¼"
schwarz- black	OZ-2602-16

RUDOLF



	seitwärts gewinkelt <i>gled to side</i>
	18 cm – 7"
schwarz- black	OZ-2602-18



Verbandscheren Bandage Scissors



SMITH



gezahnt
serrated

17,5 cm – 7"

OZ-2608-17



HARVEY



stumpf / stumpf
gezahnt
blunt / blunt
serrated

12,5 cm – 5"

OZ-2610-12



LISTER

	Typ Type	seitwärts gewinkeltan- gled to side
9 cm – 3½"		OZ-2650-09
11 cm – 4¼"		OZ-2650-11
14,5 cm – 5¾"		OZ-2650-14
	MC	OZ-2650-14M
15,5 cm – 6"		OZ-2650-15
18 cm – 7"		OZ-2650-18
	MC	OZ-2650-18M
	TC	OZ-2651-18
20 cm – 8"		OZ-2650-20
	MC	OZ-2650-20M

MC = S uperCut-Schere / SuperCut scissors TC
= Hartmetallschere / hard metal scissors

CC = Keramikbeschichtete Schere / Ceramic coated scissors W
= Wellenschliff-Schere / Wavecut scissors



Verbandscheren Bandage Scissors



LISTER

	seitwärts gewinkelt <i>an- gled to side</i>
Typ / Type	21 cm – 8¼"
	OZ-2652-21
MC	OZ-2652-21M



LISTER-EXCENTRIC

obere Schneide gezahnt,
seitwärts gewinkelt
*upper blade serrated,
angled to side*

16 cm – 6¼"	OZ-2654-16
19 cm – 7½"	OZ-2654-19



ESMARCH

	seitwärts gewinkelt <i>angled to side</i>	
Typ / Type	20 cm – 8"	22 cm – 8¾"
	OZ-2655-20	OZ-2655-22
TC	OZ-2656-20	–

MC = SuperCut-Schere / *SuperCut scissors*
= Hartmetallschere / *hard metal scissors*

CC = Keramikbeschichtete Schere / *Ceramic coated scissors*
= Wellenschliff-Schere / *Wavecut scissors*

Verbandscheren Bandage Scissors



seitwärts gewinkelt
angled to side

23 cm – 9"

OZ-2660-23

BERGMANN



gebogen
curved

23 cm – 9"

OZ-2665-23

LORENZ



seitwärts gewinkelt,
gezahnt
*angled to side,
saw edge*

17 cm – 6 $\frac{3}{4}$ "

OZ-2668-17



OZZE MEDICAL & SURGICAL SUPPLIES
TOOLS TO OPERATE

Verbandscheren Bandage Scissors



BRUNS



glatt
smooth



gezahnt
saw edge

24 cm – 9½"

OZ-2690-24	OZ-2692-24
-------------------	-------------------

Verbandscheren Bandage Scissors



BABY-BRUNS



glatt
smooth

Typ / Type	19,5 cm – 7¾"
TC	OZ-2693-20



BRUNS



glatt
smooth

Typ / Type	24 cm – 9½"
TC	OZ-2693-24

MC = SuperCut-Schere / SuperCut scissors TC
= Hartmetallschere / hard metal scissors

CC = Keramikbeschichtete Schere / Ceramic coated scissors W
= Wellenschliff-Schere / Wavecut scissors



Verbandscheren Bandage Scissors



gerade
straight

18 cm – 7"

OZ-2700-18

**SMITH
(MODELL USA)
(USA PATTERN)**



geknöpft
probe pointed

gerade
straight

14 cm – 5½"

OZ-2705-14

KNOWLES



geknöpft
probe pointed

seitwärts gewinkelt
angled to side

14 cm – 5½"

OZ-2706-14

KNOWLES



Gipsscheren
Plaster Shears

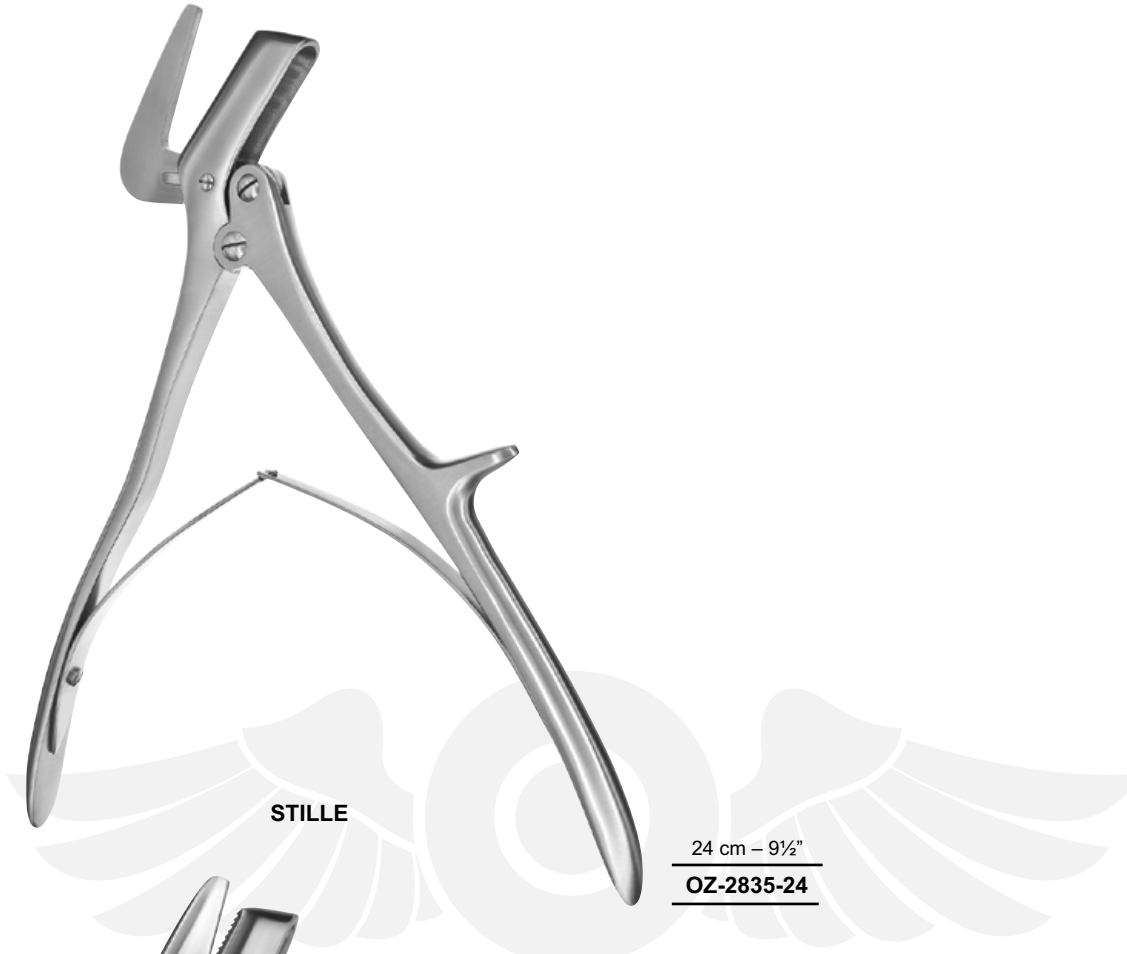

STILLE

24 cm – 9½"
OZ-2835-24



STILLE

23 cm – 9"	OZ-2840-23
26 cm – 10¼"	OZ-2840-26
37 cm – 14½"	OZ-2840-37



OZZE MEDICAL & SURGICAL SUPPLIES
TOOLS TO OPERATE

Knochenschere Bone Scissors

kniegebogen
gezahnt
curved to side
serrated



kniegebogen
gezahnt
curved to side
serrated

mit Bügel
with clamp

20 cm – 8"

OZ-2710-20



SEUTIN

23 cm – 9"

OZ-2715-23



gerade
straight

23 cm – 9"

OZ-2800-23



Rippenscheren Rib Shears

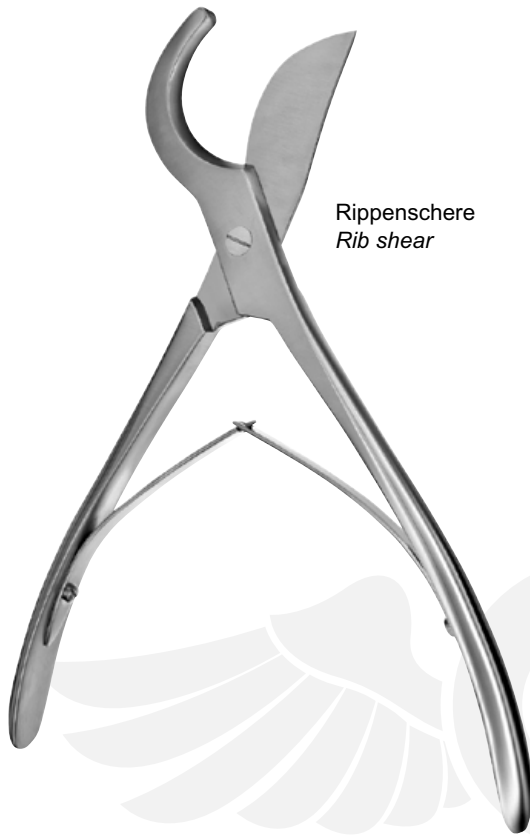

Rippenschere
Rib shear

COLLIN

22 cm – 8¾"
OZ-2805-22



Rippenschere
Rib shear

GLUCK

22 cm – 8¾"
OZ-2820-22



©ZZE MEDICAL & SURGICAL SUPPLIES

TOOLS TO OPERATE



TWO

 www.ozzesurgical.com.au

 info@ozzesurgical.com.au

Skalpelle und Messer Scalpels and Knives

Skalpelle	<i>Scalpels</i>	SK 1 - 4
Rasierklingen, Rasierklingenbrecher und -halter	<i>Razor Blades, Razor Blade Breaker and Holder</i>	SK 5 - 6
Anatomische Skalpelle	<i>Dissecting Knives</i>	SK 7
Amputationsmesser	<i>Amputation Knives</i>	SK 8
Resektions- und Seziermesser	<i>Resection- and Autopsy Knives</i>	SK 9
Dermatome	<i>Dermatomes</i>	SK 10



Mini-Klingen-System
Mini-Blade-System

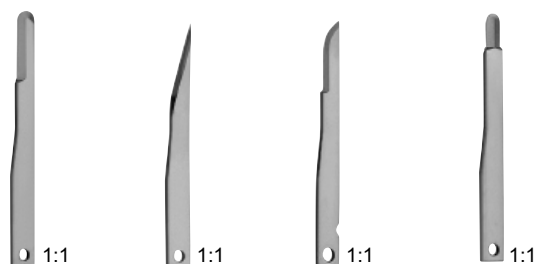

steril, Verpackungseinheit à 10 Klingen
sterile, Packing unit 10 blades

Fig. 64	Fig. 65	Fig. 67	Fig. 69
OZ-4853-64	OZ-4853-65	OZ-4853-67	OZ-4853-69



10 cm – 4"

OZ-4853-33



13,5 cm – 5¼"

OZ-4853-34



15,5 cm – 6"

OZ-4853-35



CASPAR

18 cm – 7"

OZ-4854-03



20 cm – 8"

OZ-4854-04

Skalpelle Scalpels

Verpackungseinheit à 100 Klengen
Packing unit 100 blades

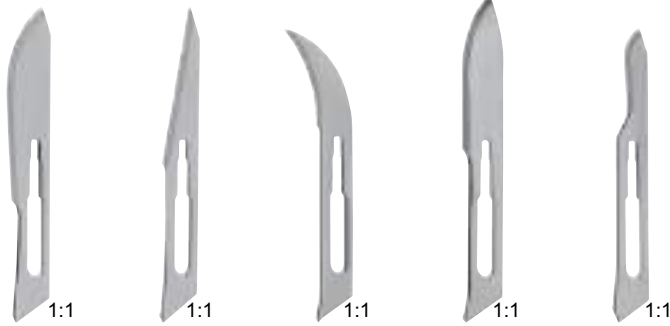

	Fig. 10	Fig. 11	Fig. 12	Fig. 13	Fig. 15
unsteril <i>non-sterile</i>	OZ-4851-10	OZ-4851-11	OZ-4851-12	OZ-4851-13	OZ-4851-15
sterilsterile	OZ-4852-10	OZ-4852-11	OZ-4852-12	OZ-4852-13	OZ-4852-15



No. 3
12,5 cm – 5"
OZ-4850-03



No. 3
12,5 cm – 5"
OZ-4850-13



No. 7
16 cm – 6¼"
OZ-4850-07



No. 7 K 12 cm
– 4¾"
OZ-4850-17



OZZE MEDICAL & SURGICAL SUPPLIES
TOOLS TO OPERATE

Verpackungseinheit à 100 Klingen
Packing unit 100 blades

Skalpelle Scalpels

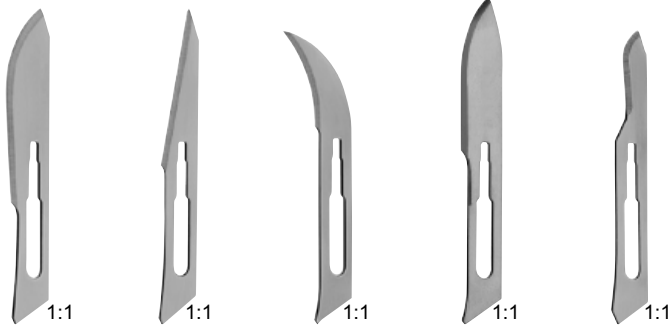

	Fig. 10	Fig. 11	Fig. 12	Fig. 13	Fig. 15
unsteril <i>non-sterile</i>	OZ-4851-10	OZ-4851-11	OZ-4851-12	OZ-4851-13	OZ-4851-15
sterilsterile	OZ-4852-10	OZ-4852-11	OZ-4852-12	OZ-4852-13	OZ-4852-15



No. 3 L
21 cm – 8¼"
OZ-4850-31



No. 3 LA 21
cm – 8¼"
OZ-4850-32

abgewinkelt
angled



No. 5
15 cm – 6"
OZ-4850-50



No. 5 A 15
cm – 6"
OZ-4850-51

abgewinkelt
angled

Skalpelle Scalpels

Verpackungseinheit à 100 Klengen
Packing unit 100 blades



	Fig. 18	Fig. 19	Fig. 20	Fig. 21	Fig. 22	Fig. 23	-
unsteril <i>non-sterile</i>	OZ-4851-18	OZ-4851-19	OZ-4851-20	OZ-4851-21	OZ-4851-22	OZ-4851-23	
sterilsterile	OZ-4852-18	OZ-4852-19	OZ-4852-20	OZ-4852-21	OZ-4852-22	OZ-4852-23	



No. 4
13,5 cm – 5¼"
OZ-4850-04



No. 4
13,5 cm – 5¼"
OZ-4850-14



No. 4 L
21 cm – 8¼"
OZ-4850-41



No. 4 LA 21
cm – 8¼"
OZ-4850-42

abgewinkelt
angeld



OZZE MEDICAL & SURGICAL SUPPLIES
TOOLS TO OPERATE

Rasierklingen, Rasierklingenbrecher und -halter Razor Blades, Razor Blade Breaker and Holder



Öffnen durch Zu-
rückschieben der
Hülse
*To open push
back the sleeve*



OZ-4874-00

Rasierklingen,
Verpackungseinheit à
10 Klingen
*Razor Blades,
Packing unit
10 blades*



TROUTMAN-CHRIS

Griffdurchmesser
Handle diameter
Ø 5,5 mm



gerade
straight



gewinkelt
angled

9 cm – 3½"

OZ-4876-09

OZ-4877-09



CASTROVIEJO

Rasierklingenhalter
mit Riegelschloss
*Razor blade holder
with slide catch*

Griffdurchmesser
Handle diameter
Ø 8 mm



gerade
straight

12,5 cm – 5"

OZ-4878-13



CASTROVIEJO

Schweizer Modell
Swiss pattern



gerade, glatt
straight, smooth

12 cm – 4¾"

OZ-4878-33

Rasierklingen, Rasierklingenbrecher und -halter Razor Blades, Razor Blade Breaker and Holder



Rasierklingen,
Verpackungseinheit à
10 Klingen
*Razor Blades,
Packing unit
10 blades*

OZ-4874-00



Öffnen durch Zu-
rückschieben der
Hülse
*To open push
back the sleeve*



Maulinnenseite:
konkav/konvex
*Jaw inside:
concave/convex*

gerade
straight

13 cm – 5"

OZ-4878-23



Rasierklingenbrecher
Razor blade breaker



gerade
straight

18,5 cm – 7¼"

OZ-4879-18

Rasierklingenhalter
mit Sperre
*Razor blade holder
with ratchet*



BARRAQUER



gerade
straight

11 cm – 4¼"

OZ-4878-53

Anatomische Skalpelle Dissecting Knives

mit Metallheft
with metal handle



Fig. 1	Fig. 2	Fig. 3	Fig. 4	Fig. 5
OZ-4858-01	OZ-4858-02	OZ-4858-03	OZ-4858-04	OZ-4858-05

spitz
pointed

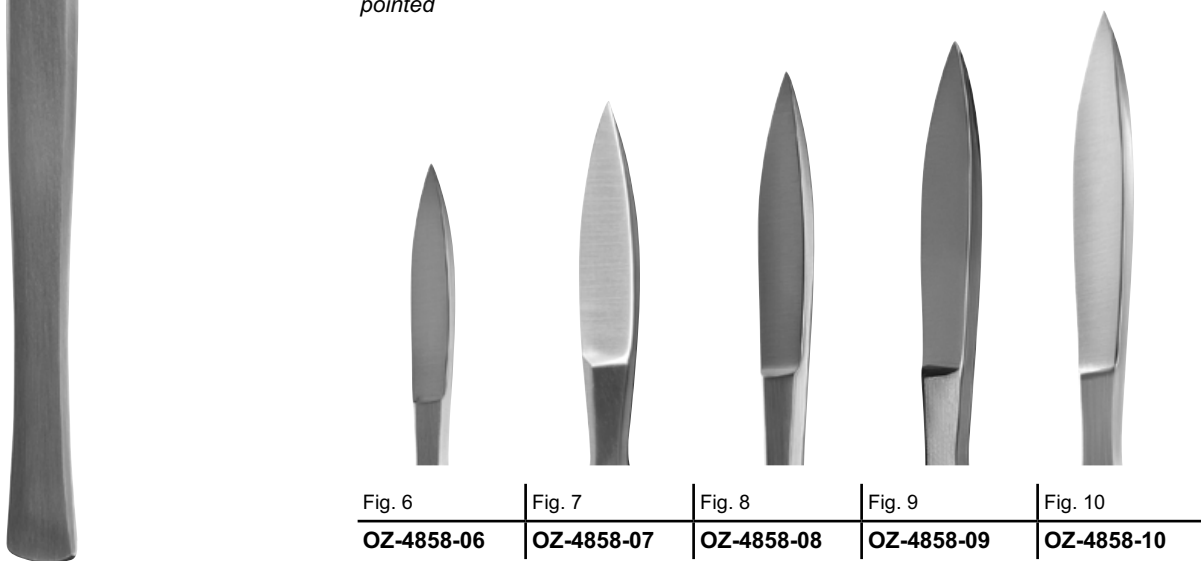
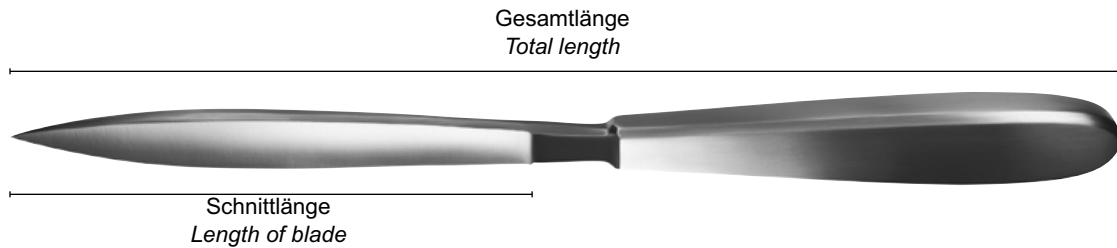

Fig. 6	Fig. 7	Fig. 8	Fig. 9	Fig. 10
OZ-4858-06	OZ-4858-07	OZ-4858-08	OZ-4858-09	OZ-4858-10

Amputationsmesser Amputation Knives



LISTON

Gesamtlänge Total length	Schnittlänge Length of blade	
26 cm – 10¼"	13 cm – 5"	OZ-4880-13
29 cm – 11½"	16 cm – 6¼"	OZ-4880-16
32 cm – 12½"	19 cm – 7½"	OZ-4880-19
35 cm – 13¾"	22 cm – 8¾"	OZ-4880-22



LISTON

Gesamtlänge Total length	Schnittlänge Length of blade	
31 cm – 12¼"	17 cm – 6¾"	OZ-4881-17
34 cm – 13½"	20 cm – 8"	OZ-4881-20



Resektions- und Seziermesser Resection- and Autopsy Knives

Gesamtlänge
Total length



Schnittlänge
Length of blade



Resektionsmesser
Resection knife

Gesamtlänge Total length	Schnittlänge Length of blade	
18 cm – 7"	5,5 cm – 2¼"	OZ-4888-05

LANGENBECK



Seziermesser
Autopsy knife

Gesamtlänge Total length	Schnittlänge Length of blade	
27 cm – 10½"	12 cm – 4¾"	OZ-4892-11

1:3



Seziermesser
Autopsy knife

Gesamtlänge Total length	Schnittlänge Length of blade	
23 cm – 9"	9 cm – 3½"	OZ-4894-09

1:3

VIRCHOW



Dermatome Dermatomes



30 cm – 11¾"

OZ-4899-00

SCHINK



Ersatzklinge, allein
Spare blade, only

OZ-4899-01



19 cm – 7½"

OZ-4899-03

SILVER

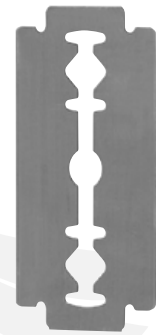

Ersatzklingen,
Verpackungseinheit à
10 Klingen

Spare blades,
Packing unit 10
blades

OZ-4899-10

Dermatom **SCHINK**, einstellbar von 0,1 mm - 2,0 mm, komplett mit 1 x auswechselbarer Klinge MA 4899-01 und 2 Spannplatten MA 4899-02

Dermatome **SCHINK**, adjustable from 0.1 mm - 2.0 mm, complete with 1 exchangeable blade MA 4899-01 and 2 straightening plates MA 4899-02



Spannplatte allein für alle Dermatome verwendbar
Skin straightening plate only usable for all dermatomes

OZ-4899-02



©ZZE MEDICAL & SURGICAL SUPPLIES

TOOLS TO OPERATE



THREE

 www.ozzesurgical.com.au

 info@ozzesurgical.com.au

Mikro-Uhrmacher Pinzetten	<i>Micro Jewelers Forceps</i>	FC 1
Mikro-Nahtpinzetten	<i>Micro Suture Forceps</i>	FC 2 - 3
Anatomische Mikro-Pinzetten	<i>Dissecting Micro Forceps</i>	FC 4 - 7
Mikro-Tumorfaßpinzetten	<i>Micro Tumor Grasping Forceps</i>	FC 8 - 9
Mikro-Pinzetten, Rundgriff	<i>Micro Forceps, Round Handle</i>	FC 10
Feine anatomische Pinzetten	<i>Delicate Dissecting Forceps</i>	FC 11 - 18
Anatomische Pinzetten	<i>Dissecting Forceps</i>	FC 19 - 21
Atraumatische Pinzetten	<i>Atraumatic Forceps</i>	FC 22
Ohrpinzetten	<i>Ear Dressing Forceps</i>	FC 23 - 24
Feine chirurgische Pinzetten	<i>Delicate Tissue Forceps</i>	FC 25 - 32
Chirurgische Pinzetten	<i>Tissue Forceps</i>	FC 33 - 36
Hautpinzetten	<i>Skin Forceps</i>	FC 37
Darm- und Lungenpinzetten	<i>Intestinal and Lung Forceps</i>	FC 38
Fasspinzetten	<i>Grasping Forceps</i>	FC 39
Splitterpinzetten	<i>Splinter Forceps</i>	FC 40
Splitterzangen	<i>Splinter Forceps</i>	FC 41
Cilienpinzetten	<i>Cilia Forceps</i>	FC 42



OZZE MEDICAL & SURGICAL SUPPLIES
TOOLS TO OPERATE

Mikro-Uhrmacher-Pinzetten Micro Jewelers Forceps

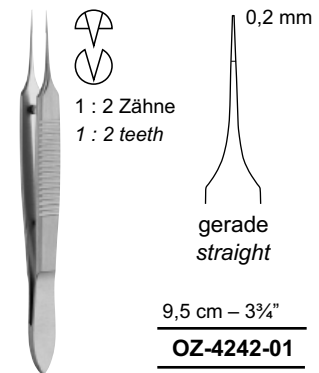
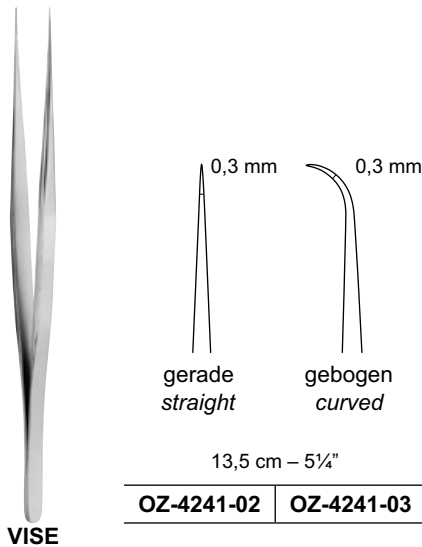
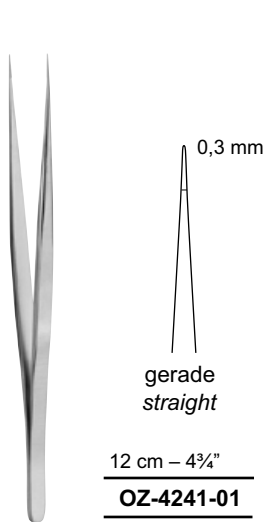
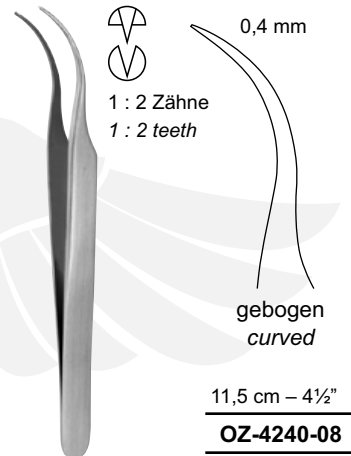
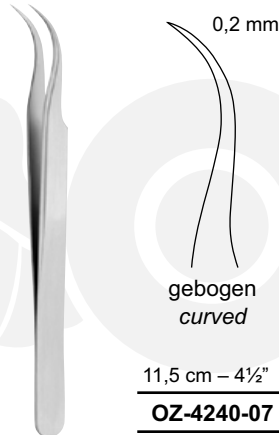
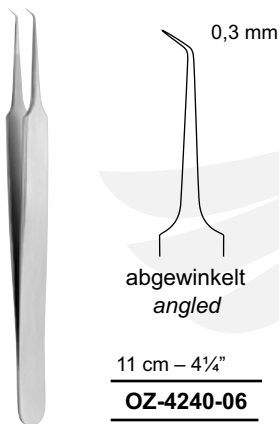
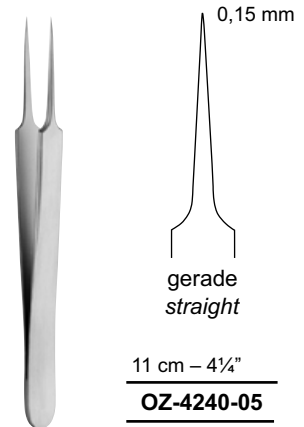
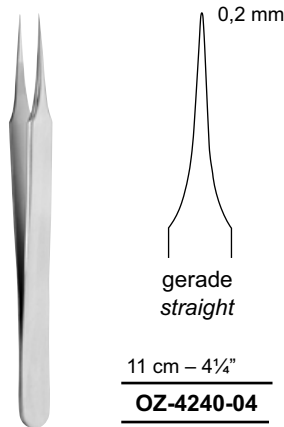
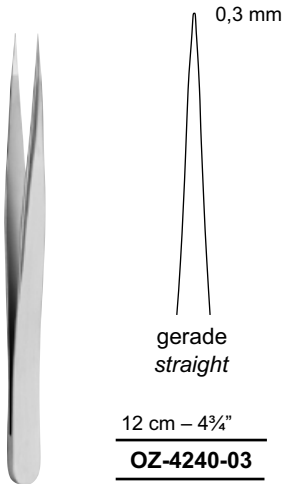



Mikro-Nahtpinzetten Micro Suture Forceps

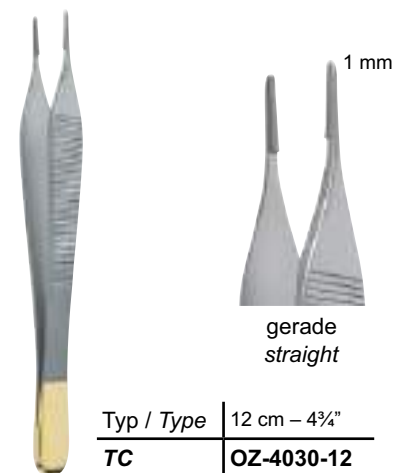
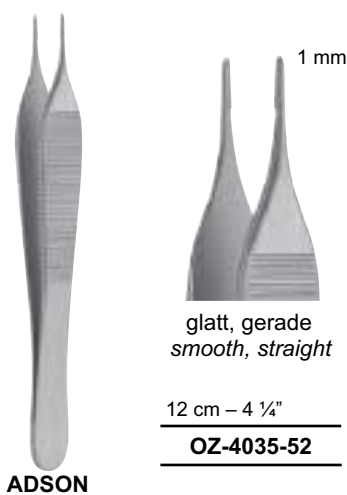
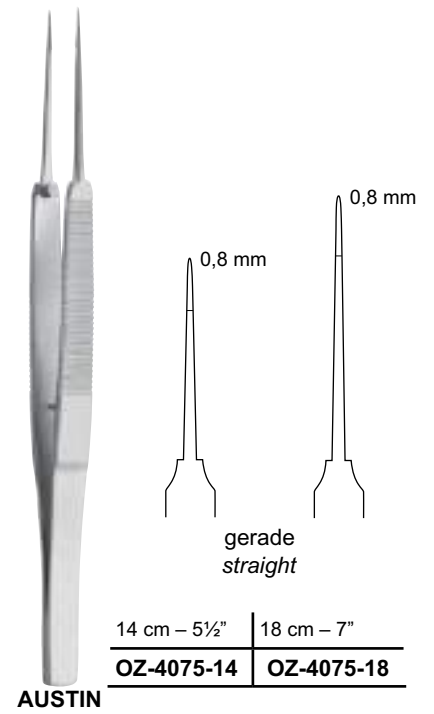
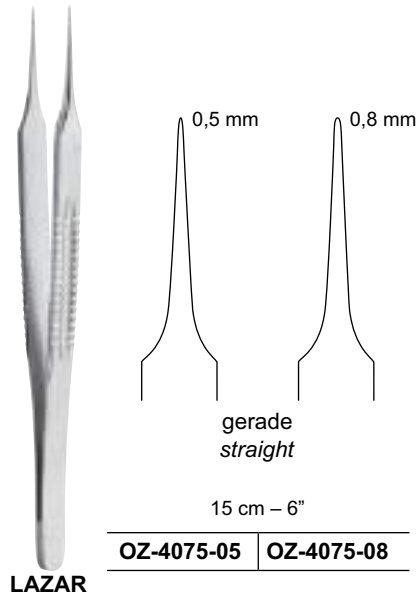



OZZE MEDICAL & SURGICAL SUPPLIES
TOOLS TO OPERATE

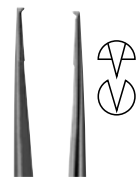



Anatomische Mikro-Pinzetten Dissecting Micro Forceps

OZZE MEDICAL & SURGICAL SUPPLIES
TOOLS TO OPERATE

Evolution / Nano

leichter als Titan dank neuem Griff-Design
alle Vorzüge von Edelstahlinstrumenten
außergewöhnlich gute Haptik für präzises Arbeiten
problemloses Reinigen für bestmögliche Hygiene
optimale Ergonomie dank der runden Griffschalen

Evolution / Nano

*lighter than titanium thanks to the new handle design
all advantages of stainless steel instruments
unsurpassed haptics for precision during the operation
easy cleaning for best possible hygiene
optimal ergonomomy due to the round shell handles*

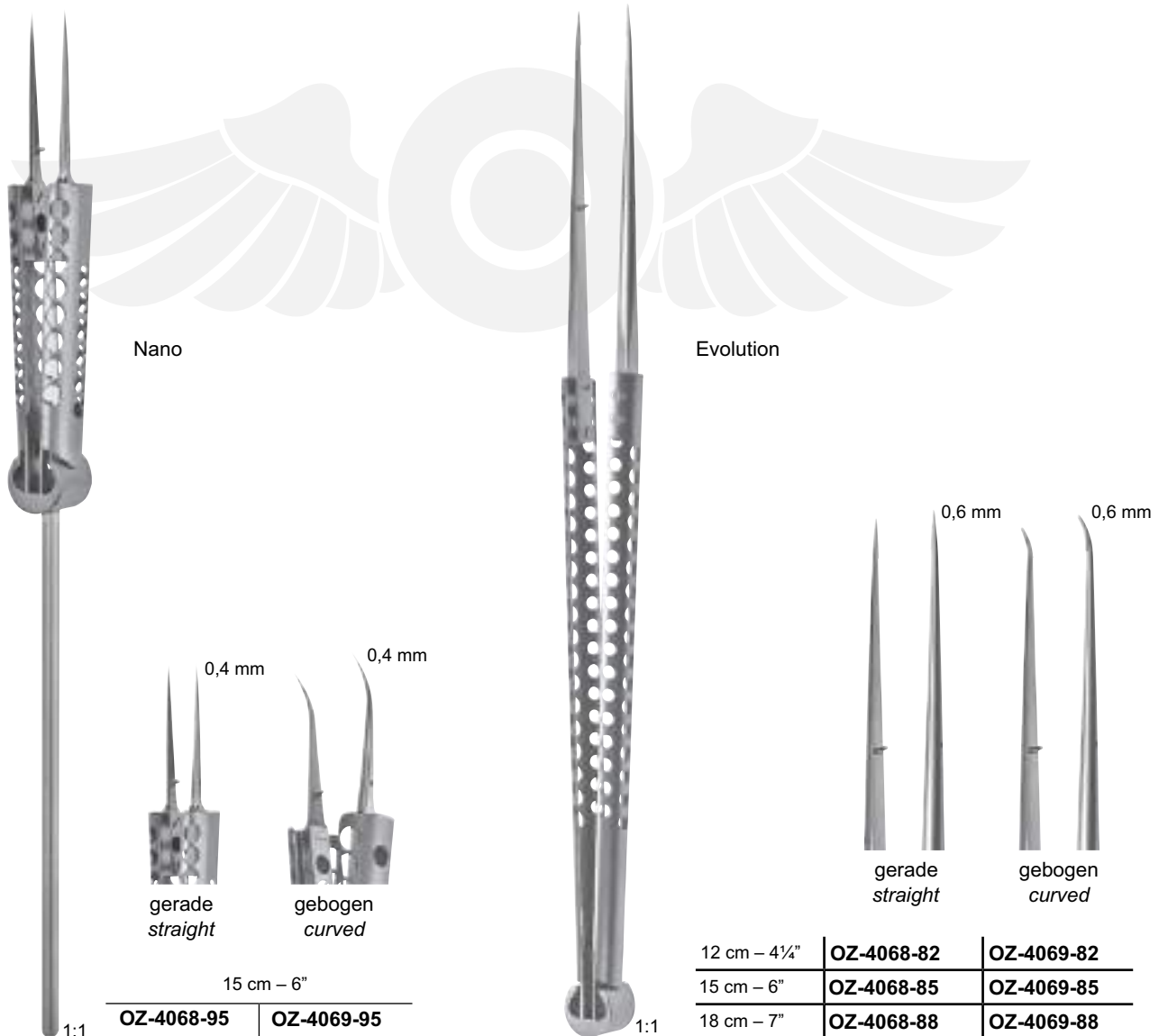



Anatomische Mikro-Pinzetten Dissecting Micro Forceps



YASARGIL

bajonettförmig
bayonet-shaped

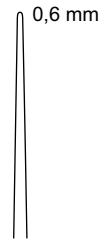

0,6 mm
glatt, gerade
smooth, straight

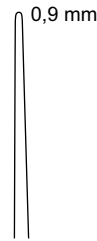

0,9 mm
gerade
straight

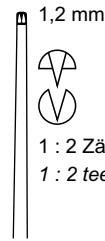

1,2 mm
1 : 2 Zähne
1 : 2 teeth

16 cm – 6¼"	OZ-4063-22	OZ-4063-24	–
18 cm – 7"	OZ-4063-32	OZ-4063-34	OZ-4063-36
20 cm – 8"	OZ-4063-42	OZ-4063-44	–
22 cm – 8¾"	OZ-4063-52	OZ-4063-54	–
24 cm – 9½"	OZ-4063-62	OZ-4063-64	–

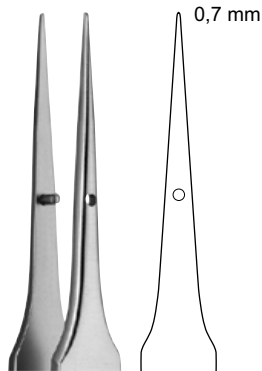

0,7 mm
gerade
straight

15 cm – 6"	OZ-4065-15
18 cm – 7"	OZ-4065-18



bajonettförmig
bayonet-shaped

JACOBSEN



0,6 mm
gerade
straight

16 cm – 6¼"	OZ-4078-16
-------------	-------------------



OZZE MEDICAL & SURGICAL SUPPLIES
TOOLS TO OPERATE

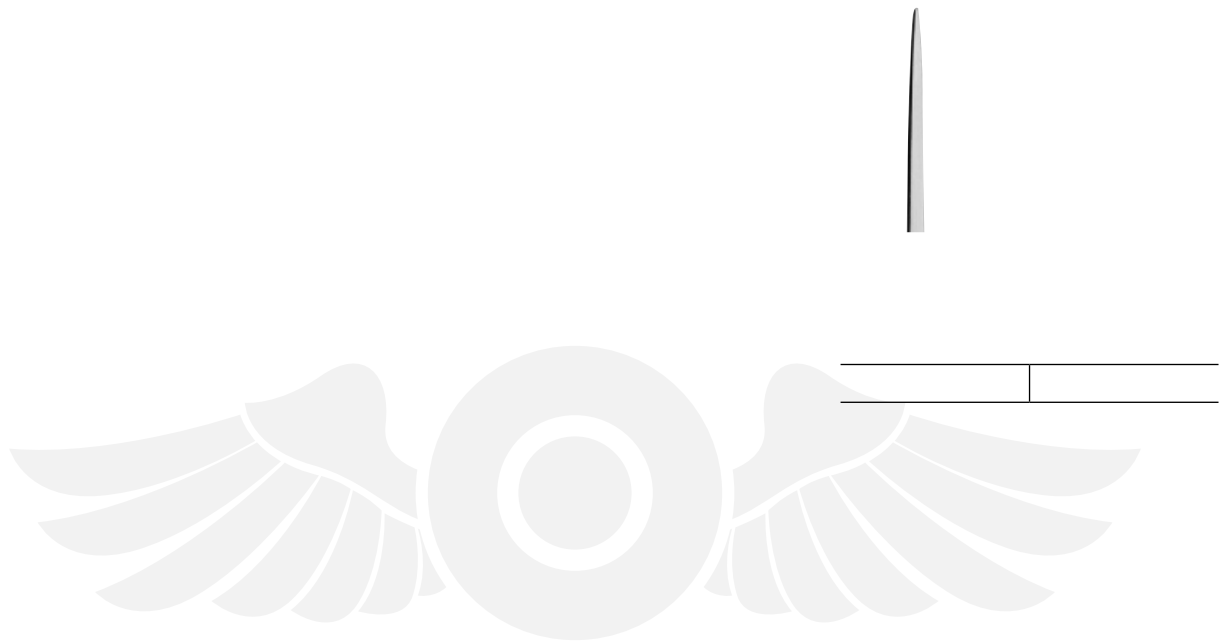



OZZE MEDICAL & SURGICAL SUPPLIES
TOOLS TO OPERATE

Anatomische Mikro-Pinzetten Dissecting Micro Forceps



bajonettförmig
bayonet-shaped

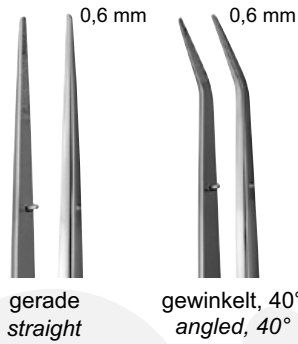

Typ / Type	19 cm – 7½"	
MG	OZ-4078-30G	OZ-4078-31G



bajonettförmig
bayonet-shaped

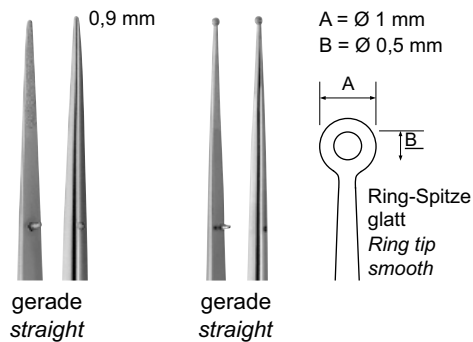

Typ / Type	22 cm – 8¾"	
MG	OZ-4078-40G	OZ-4078-41G



Mikro-Tumorfasspinzetten Micro Tumor Grasping Forceps



bajonettförmig
bayonet-shaped



Maul löffelförmig
Jaw spoon shaped



Maul flach gezahnt
Jaw flat serrated



Maul kürettenförmig
Jaw curette shaped

22 cm – 8¾"

OZ-4078-01

OZ-4078-03

OZ-4078-05

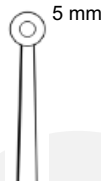

Maul löffelförmig
Jaw spoon shaped



Maul flach gezahnt
Jaw flat serrated

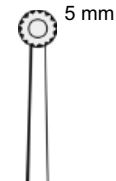

Maul kürettenförmig
Jaw curette shaped

22 cm – 8¾"

OZ-4078-02

OZ-4078-04

OZ-4078-06



bajonettförmig
bayonet-shaped



Maul löffelförmig
Jaw spoon shaped



Maul flach gezahnt
Jaw flat serrated



Maul abgewinkelt
Jaw curette angled

20 cm – 8"

OZ-4078-10

OZ-4078-11

OZ-4078-60

HUNT









OZZE MEDICAL & SURGICAL SUPPLIES
TOOLS TO OPERATE

Mikro-Tumorfasspinzetten Micro Tumor Grasping Forceps



YASARGIL

leichter
bajonettförmig
*light perforated handle,
bayonet-shaped*

	 Ø 3 mm	 Ø 5 mm	 Ø 7 mm	Lochgriff,
22 cm – 8¾"	OZ-4064-51	OZ-4064-52	–	
24 cm – 9½"	OZ-4064-61	OZ-4064-62	OZ-4064-63	
	 Ø 3 mm	 Ø 3 mm		
22 cm – 8¾"	OZ-4064-54	OZ-4064-55		
	 Ø 5 mm	 Ø 5 mm		
22 cm – 8¾"	OZ-4064-57	OZ-4064-58		



Mikro-Pinzetten, Rundgriff

Micro Forceps, Round Handle

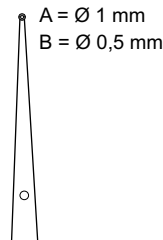
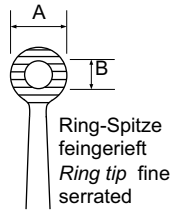
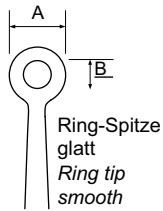

Typ
Type
feingerieft
fine serrated

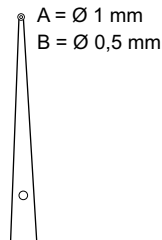

glatt
smooth

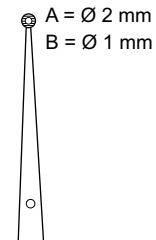

feingerieft
fine serrated

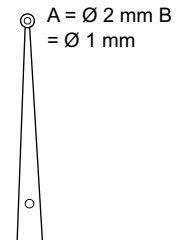

glatt
smooth

15 cm – 6"	TI	OZ-4079-12	OZ-4079-14	–	–
18 cm – 7"		–	–	OZ-4079-36	OZ-4079-38
18 cm – 7"	TI	OZ-4079-32T	OZ-4079-34T	OZ-4079-36T	OZ-4079-38T
22 cm – 8¾"		OZ-4079-52	OZ-4079-54	OZ-4079-56	OZ-4079-58

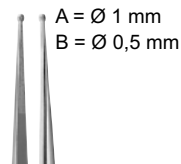

Typ
Type
gerade
straight

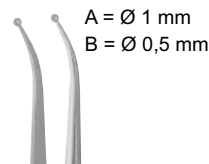

gebogen
curved

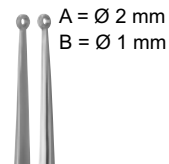

gerade
straight

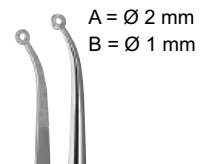

gebogen
curved

15 cm – 6"	MG	OZ-4068-74G	OZ-4068-75G	–	–
15 cm – 6"	MG/TI	OZ-4079-12U	–	OZ-4079-16U	–
18 cm – 7"	MG	OZ-4079-32G	OZ-4079-33G	OZ-4079-36G	OZ-4079-37G
18 cm – 7"	MG/TI	OZ-4079-32U	–	OZ-4079-36U	–
21 cm – 8¼"	MG	OZ-4079-42G	OZ-4079-43G	OZ-4079-46G	OZ-4079-47G



Feine anatomische Pinzetten Delicate Dissecting Forceps



ADSON



gerade
straight

12,5 cm – 5"	OZ-7585-12
15 cm – 6"	OZ-7585-15



10 cm – 4"

OZ-4250-10	OZ-4251-10	OZ-4252-10
-------------------	-------------------	-------------------



SEMKEN



12,5 cm – 5"	OZ-4040-12	OZ-4041-12
15 cm – 6"	OZ-4040-15	OZ-4041-15

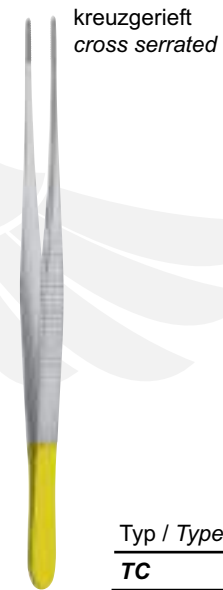

SEMKEN



Typ / Type	15 cm – 6"
TC	OZ-4042-15



MC INDOE



15 cm – 6"	OZ-4038-15
------------	-------------------



MC INDOE



Typ / Type	15 cm – 6"
TC	OZ-4039-15



Feine anatomische Pinzetten Delicate Dissecting Forceps



BRAIN



gerade
straight

17,5 cm – 7"

OZ-4048-18



WAUGH



gerade
straight

15 cm – 6"

OZ-4055-15

18 cm – 7"

OZ-4055-18

20 cm – 8"

OZ-4055-20



glatt, gerade
smooth, straight

18 cm – 7"

OZ-4056-18

20 cm – 8"

OZ-4056-20



OZZE MEDICAL & SURGICAL SUPPLIES
TOOLS TO OPERATE

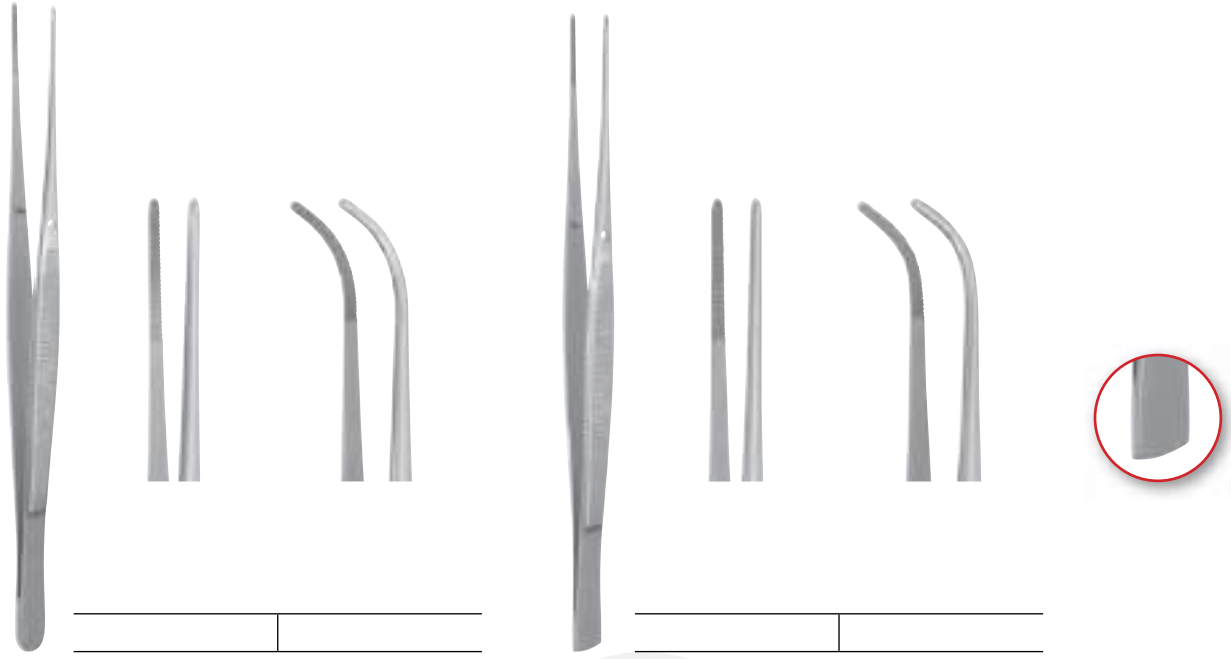



Feine anatomische Pinzetten Delicate Dissecting Forceps

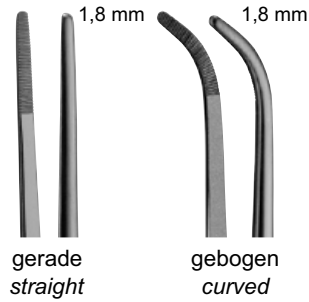

18 cm – 7"

OZ-4080-17	OZ-4081-17
------------	------------

CUSHING

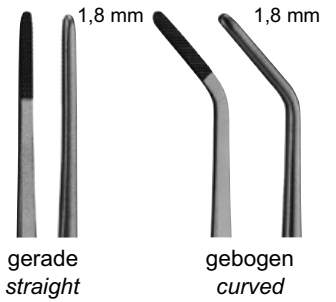

Typ / Type

18 cm – 7"

TC	OZ-4082-17	OZ-4082-27
----	------------	------------

CUSHING



bajonettförmig
bayonet-shaped



Typ / Type | 18 cm – 7"

TC	OZ-4083-17
----	------------

CUSHING-TAYLOR



OZZE MEDICAL & SURGICAL SUPPLIES
TOOLS TO OPERATE

Feine anatomische Pinzetten Delicate Dissecting Forceps



BROPHY

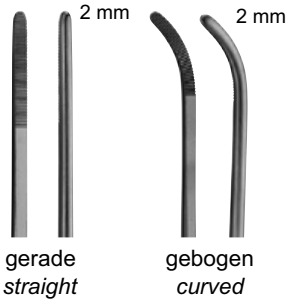

gerade
straight

gebogen
curved

20 cm – 8"

OZ-4060-20

OZ-4061-20



gewinkelt
angled

20 cm – 8"

OZ-4057-20



gerade
straight

20 cm – 8"

OZ-4058-20



Feine anatomische Pinzetten Delicate Dissecting Forceps



POTTS-SMITH

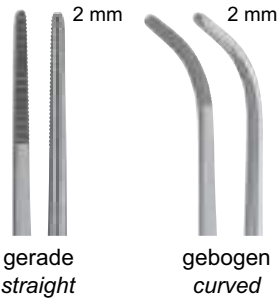

18 cm – 7"	OZ-4090-18	OZ-4091-18
21 cm – 8¼"	OZ-4090-21	OZ-4091-21
25 cm – 10"	OZ-4090-25	OZ-4091-25



POTTS-SMITH

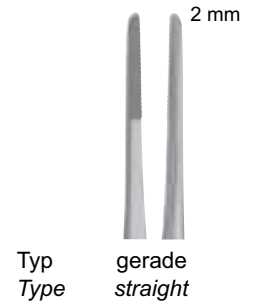

15 cm – 6"	TC	OZ-4092-15
18 cm – 7"	TC	OZ-4092-18
20 cm – 8"	TC	OZ-4092-20
23 cm – 9"	TC	OZ-4092-23
25 cm – 10"	TC	OZ-4092-25



GRÜNWALD

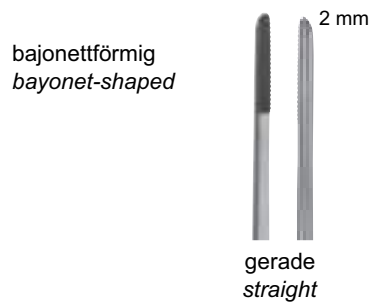

Typ / Type	19 cm – 7½"
TC	OZ-4084-18



OZZE MEDICAL & SURGICAL SUPPLIES
TOOLS TO OPERATE





Anatomische Pinzetten Dissecting Forceps

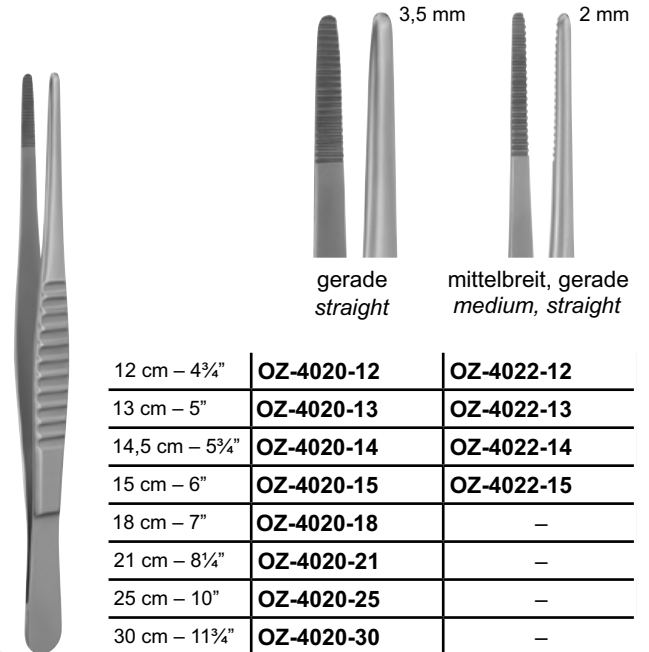
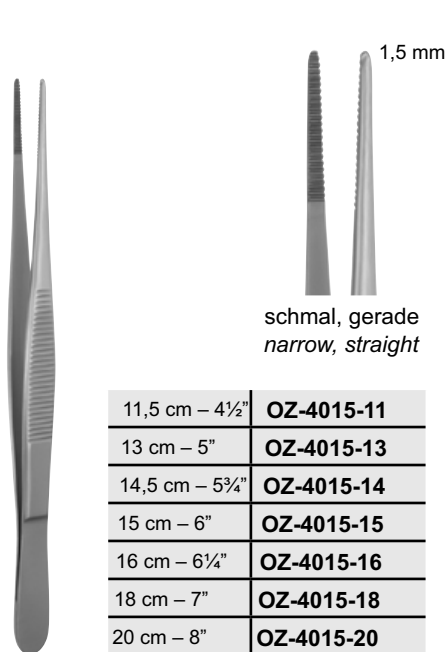

MODELL USA
USA PATTERN

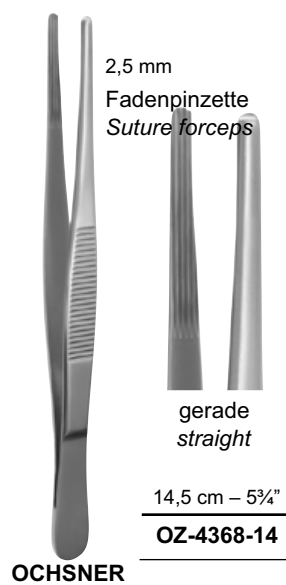
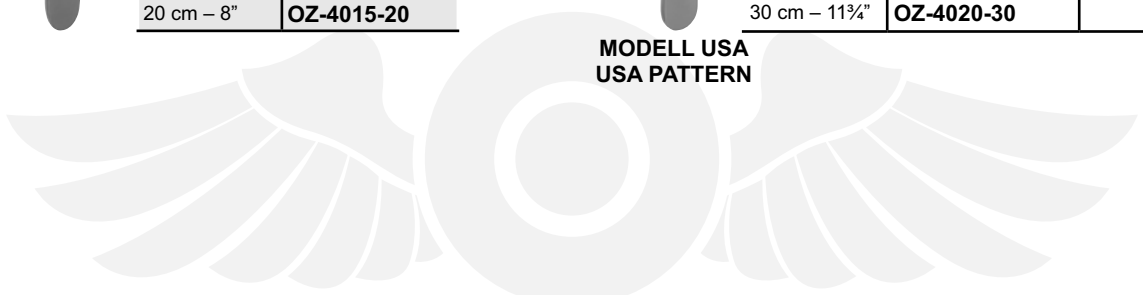



OZZE MEDICAL & SURGICAL SUPPLIES
TOOLS TO OPERATE





Atraumatische Pinzetten Atraumatic Forceps



DE BAKEY Zahnung
DE BAKEY Serration



DE BAKEY

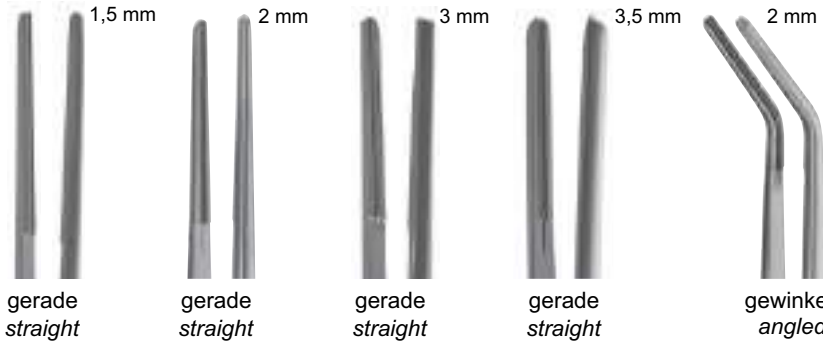

15 cm – 6"	OZ-7580-16	OZ-7581-16	OZ-7582-16	OZ-7583-16	OZ-7584-16
20 cm – 8"	OZ-7580-20	OZ-7581-20	OZ-7582-20	OZ-7583-20	OZ-7584-20
24 cm – 9½"	OZ-7580-24	OZ-7581-24	OZ-7582-24	OZ-7583-24	OZ-7584-24
30 cm – 11¾"	OZ-7580-30	OZ-7581-30	OZ-7582-30	OZ-7583-30	OZ-7584-30



DE BAKEY Zahnung
DE BAKEY Serration



DE BAKEY

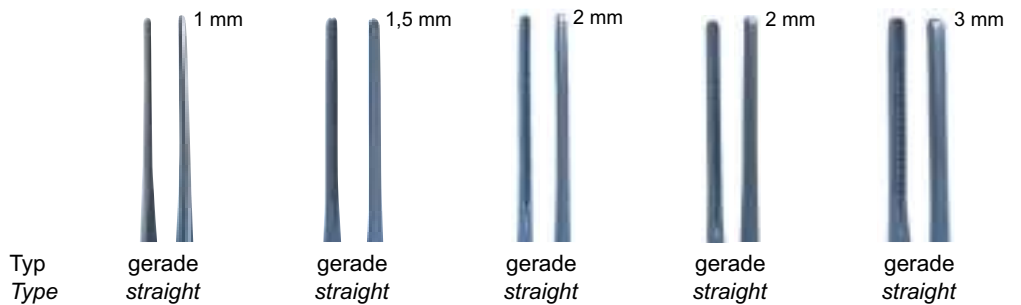

15 cm – 6"	TI	OZ-7580-01T	OZ-7580-16T	OZ-7581-01T	OZ-7582-01T	OZ-7582-16T
20 cm – 8"	TI	OZ-7580-02T	OZ-7580-20T	OZ-7581-02T	OZ-7582-02T	OZ-7582-20T
24 cm – 9½"	TI	OZ-7580-03T	OZ-7580-24T	OZ-7581-03T	OZ-7582-03T	OZ-7582-24T



Ohrpinzetten Ear Dressing Forceps

bajonettförmig
bayonet-shaped

1 : 2 Zähne
1 : 2 teeth

	14 cm – 5½"	
1 mm	OZ-7862-24	OZ-7863-14
2 mm	OZ-7862-14	–

LUCAE

Fixierpinzette
Fixing forceps

bajonettförmig
bayonet-shaped

gerade, gezahnt,
gerieft
straight, toothed,
serrated

2 mm

14 cm – 5½"

OZ-7863-15

COTTLE



bajonettförmig
bayonet-shaped

1 : 2 Zähne
1 : 2 teeth

	2,2 mm	1 mm
16 cm – 6¼"	OZ-7864-16	OZ-7864-26
19,5 cm – 7¾"	OZ-7864-18	OZ-7864-28
21 cm – 8¼"	OZ-7864-20	OZ-7864-30

JANSEN-GRUENWALD

bajonettförmig
bayonet-shaped

2 mm

16 cm – 6¼"	OZ-7865-16
20 cm – 8"	OZ-7865-20

JANSEN



Ohrpinzetten Ear Dressing Forceps

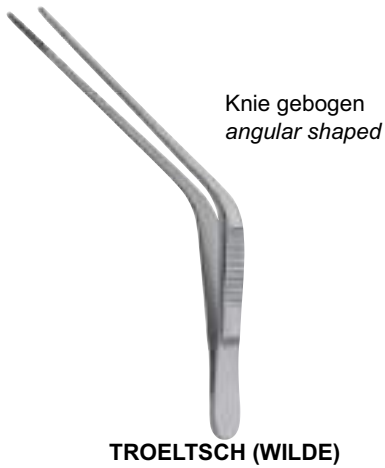

10,5 cm – 4¼"	OZ-7860-11
11,5 cm – 4½"	OZ-7860-12
15 cm – 6"	OZ-7860-15
18 cm – 7"	OZ-7860-18



2 mm
12 cm – 4¾"
OZ-7861-12

1 : 2 Zähne
1 : 2 teeth



12 cm – 4¾"
OZ-7866-12

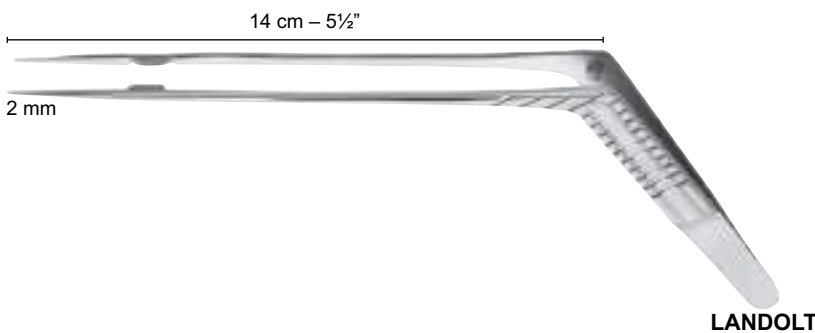

21,5 cm – 8½"
OZ-4095-00



Feine chirurgische Pinzetten Delicate Tissue Forceps

1 : 2 Zähne
1 : 2 teeth

 gerade <i>straight</i> sehr fein <i>very delicate</i> OZ-4260-10	 leicht gebogen <i>slightly curved</i> sehr fein <i>very delicate</i> 10 cm – 4" OZ-4261-10	 stark gebogen <i>strongly curved</i> sehr fein <i>very delicate</i> OZ-4262-10
--	---	--

1 : 2 Zähne
1 : 2 teeth

 gerade, kreuzgerieft <i>straight, cross serrated</i> OZ-4133-01	 OZ-4133-02	 gerade <i>straight</i> OZ-4133-03	 OZ-4133-04
---	----------------	---	----------------

12 cm – 4¾"

ADSON

1 : 2 Zähne
1 : 2 teeth

0,8 mm

15 cm – 6"
OZ-4133-10

ADSON

1 : 2 Zähne
1 : 2 teeth

 gerade <i>straight</i> OZ-4130-12	 OZ-4130-22
---	----------------

Typ
Type

12 cm – 4¾"	TC	OZ-4130-12	OZ-4130-22
15 cm – 6"	TC	OZ-4130-15	OZ-4130-25

MICRO ADSON



Feine chirurgische Pinzetten Delicate Tissue Forceps



1 : 2 Zähne
1 : 2 teeth

STANDARD ADSON



1 mm

kniegebogen
curved

12 cm – 4¾"

OZ-4135-72



1 : 2 Zähne
1 : 2 teeth

ADSON



1,5 mm
kreuzgerieft
cross serrated

12 cm – 4¾"

OZ-4136-12



STANDARD ADSON



1,5 mm



1 : 2 Zähne
1 : 2 teeth

12 cm – 4¾"

OZ-4135-12

15 cm – 6"

OZ-4135-15



2 mm



2 : 3 Zähne
2 : 3 teeth

OZ-4135-52

OZ-4135-55



ADSON-EWALD



1 : 2 Zähne
1 : 2 teeth



2 mm

12 cm – 4¾"

OZ-4132-12



STANDARD ADSON



1 : 2 Zähne
1 : 2 teeth



2 mm

Typ gerade
Type straight

12 cm – 4¾"

TC

OZ-4134-12

15 cm – 6"

TC

OZ-4134-15



OZZE MEDICAL & SURGICAL SUPPLIES
TOOLS TO OPERATE

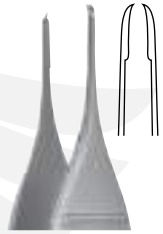



Feine chirurgische Pinzetten Delicate Tissue Forceps

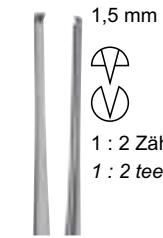

1 : 2 Zähne
1 : 2 teeth

SEMKEN

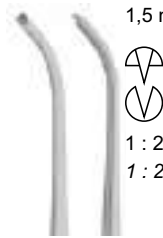

1 : 2 Zähne
1 : 2 teeth

SEMKEN

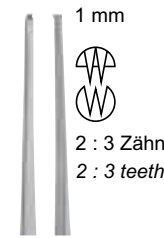

2 : 3 Zähne
2 : 3 teeth

MICRO-SEMKEN

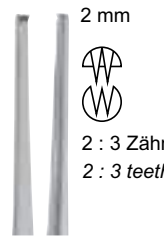

2 : 3 Zähne
2 : 3 teeth

MICRO-SEMKEN

12,5 cm – 5"	OZ-4140-12	OZ-4141-12	OZ-4140-30	OZ-4142-12
15 cm – 6"	OZ-4140-15	OZ-4141-15	OZ-4140-31	OZ-4142-15



1 : 2 Zähne
1 : 2 teeth



Typ
Type



gerade
straight

14,5 cm – 5"	TC	OZ-4140-24	–
16 cm – 6¼"	TC	–	OZ-4140-26
18 cm – 7"	TC	OZ-4140-28	–

MICRO-SEMKEN

Feine chirurgische Pinzetten Delicate Tissue Forceps

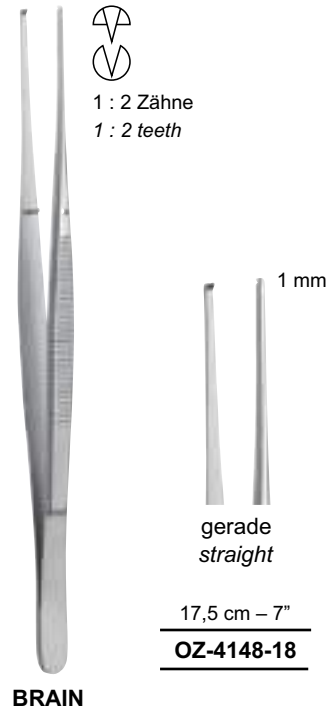
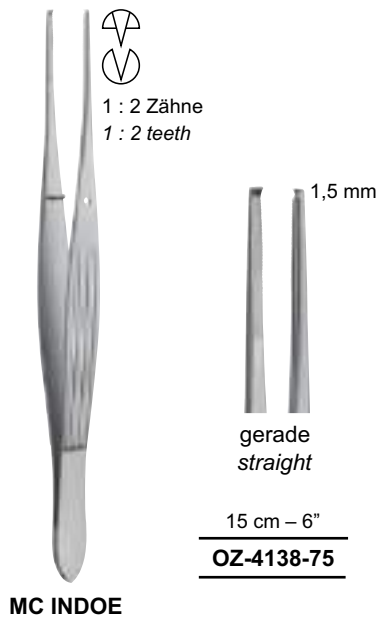
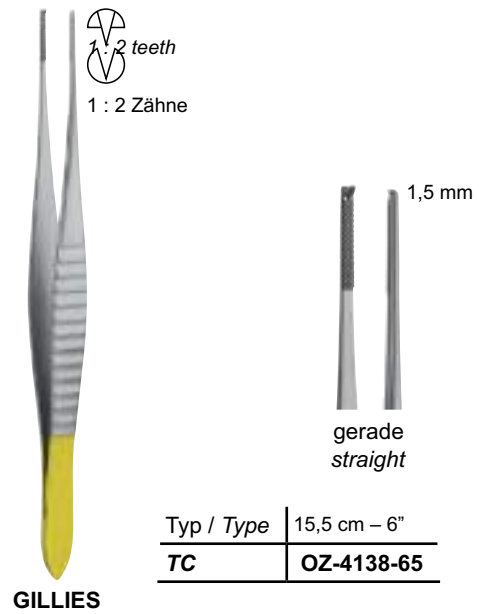
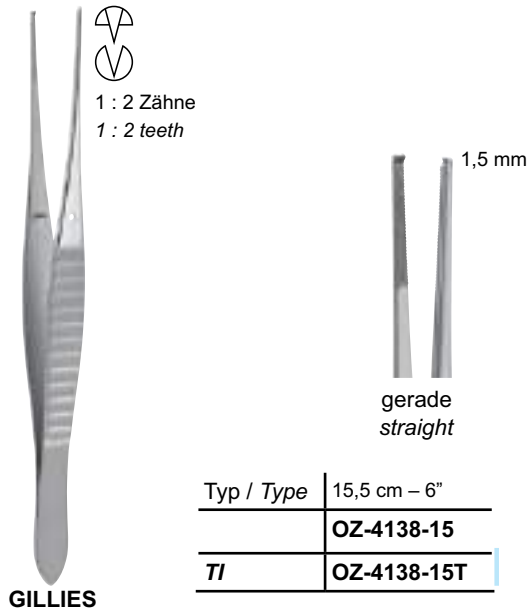



Feine chirurgische Pinzetten Delicate Tissue Forceps



1 : 2 Zähne
1 : 2 teeth



1,5 mm

Typ
Type gerade
straight

14,5 cm – 5¾"	TC	OZ-4101-14
16 cm – 6¼"	TC	OZ-4101-16
18 cm – 7"	TC	OZ-4101-18
20 cm – 8"	TC	OZ-4101-20
25 cm – 10"	TC	OZ-4101-25
30 cm – 11¾"	TC	OZ-4101-30

OEHLER



1 : 2 Zähne
1 : 2 teeth



1,5 mm

gerade
straight

15 cm – 6"	OZ-4155-15
18 cm – 7"	OZ-4155-18
20 cm – 8"	OZ-4155-20
25 cm – 10"	OZ-4155-25
30 cm – 11¾"	OZ-4155-30

WAUGH





1 : 2 Zähne
1 : 2 teeth



1,5 mm

gerade
straight



1,5 mm

gebogen
curved

18 cm – 7"	OZ-4190-18	OZ-4191-18
21 cm – 8¼"	OZ-4190-21	OZ-4191-21
25 cm – 10"	OZ-4190-25	OZ-4191-25

POTTS-SMITH



1 : 2 Zähne
1 : 2 teeth

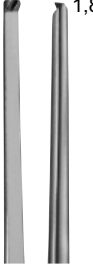

1,8 mm

gerade
straight



1,8 mm

gebogen
curved

18 cm – 7"	OZ-4180-17	OZ-4181-17
------------	------------	------------

CUSHING



Feine chirurgische Pinzetten Delicate Tissue Forceps

1 : 2 Zähne
1 : 2 teeth

2 mm 2 mm

gerade
straight

gebogen
curved

20 cm – 8"

OZ-4160-20	OZ-4161-20
-------------------	-------------------

BROPHY

1 : 2 Zähne
1 : 2 teeth

1,5 mm 1,5 mm

gerade
straight

gebogen
curved

17,5 cm – 7"

OZ-4170-18	OZ-4171-18
-------------------	-------------------

GERALD

1 : 2 Zähne
1 : 2 teeth

bajonettförmig
bayonet-shaped

1,5 mm

gerade
straight

19 cm – 7½"

OZ-4171-59

GERALD



Feine chirurgische Pinzetten Delicate Tissue Forceps

1 : 2 Zähne
1 : 2 teeth

1,5 mm

gerade
straight

gebogen
curved

17,5 cm – 7"

OZ-4150-17 | **OZ-4151-17**

TAYLOR

1,5 mm

gerade
straight

mit Dissektorende
with dissector end

17,5 cm – 7"

OZ-4152-17

TAYLOR

1 : 2 Zähne
1 : 2 teeth

1,5 mm

gerade
straight

mit Dissektorende
with dissector end

18 cm – 7" | **OZ-4154-17**
20 cm – 6" | **OZ-4154-20**

TAYLOR

Chirurgische Pinzetten Tissue Forceps



1 : 2 Zähne
1 : 2 teeth

Standard Modell
Standard pattern

10,5 cm – 4¼"	OZ-4100-10
11,5 cm – 4½"	OZ-4100-11
13 cm – 5"	OZ-4100-13
14,5 cm – 5¾"	OZ-4100-14
15,5 cm – 6"	OZ-4100-15
16 cm – 6¼"	OZ-4100-16
18 cm – 7"	OZ-4100-18
20 cm – 8"	OZ-4100-20
25 cm – 10"	OZ-4100-25
30 cm – 11¾"	OZ-4100-30



gerade
straight



1 : 2 Zähne
1 : 2 teeth

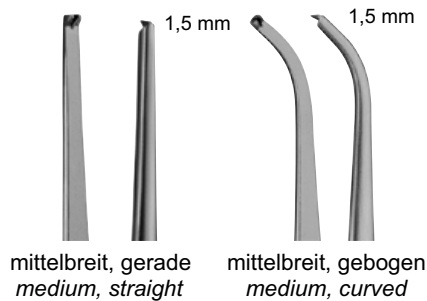

mittelbreit, gerade
medium, straight

mittelbreit, gebogen
medium, curved

11,5 cm – 4½"	OZ-4110-11	–
13 cm – 5"	OZ-4110-13	–
14,5 cm – 5¾"	OZ-4110-14	OZ-4111-14
15,5 cm – 6"	–	–
16 cm – 6¼"	OZ-4110-16	–
18,5 cm – 7¼"	OZ-4110-18	–
20 cm – 8"	OZ-4110-20	–
25 cm – 10"	OZ-4110-25	–



1 : 2 Zähne
1 : 2 teeth

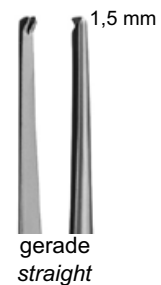

gerade
straight

16 cm – 6¼"
OZ-4109-16

Chirurgische Pinzetten Tissue Forceps



Standard Modell
Standard pattern



3 mm



2 : 3 Zähne
2 : 3 teeth

gerade
straight



4,5 mm



3 : 4 Zähne
3 : 4 teeth

gerade
straight

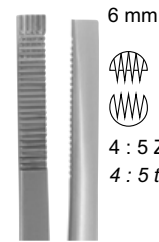

6 mm



4 : 5 Zähne
4 : 5 teeth

gerade
straight

11,5 cm – 4½"	–	OZ-4103-13	–
13 cm – 5"	OZ-4102-13	OZ-4103-14	OZ-4104-13
14,5 cm – 5¾"	OZ-4102-14	–	OZ-4104-14
15,5 cm – 6"	–	OZ-4103-16	–
16 cm – 6¼"	OZ-4102-16	–	OZ-4104-16
18 cm – 7"	OZ-4102-18	–	–
20 cm – 8"	OZ-4102-20	OZ-4103-20	–
25 cm – 10"	OZ-4102-25	–	–
30 cm – 11¾"	OZ-4102-30	–	–



MODELL USA
USA PATTERN

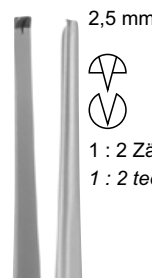

2,5 mm



1 : 2 Zähne
1 : 2 teeth

gerade
straight

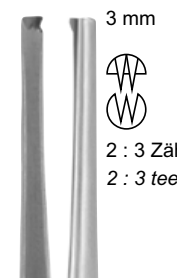

3 mm



2 : 3 Zähne
2 : 3 teeth

gerade
straight

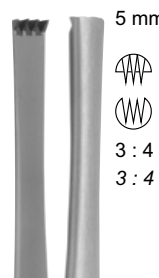

5 mm



3 : 4 Zähne
3 : 4 teeth

gerade
straight

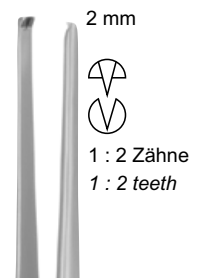

2 mm



1 : 2 Zähne
1 : 2 teeth

schmal, gerade
narrow, straight

12 cm – 4¾"	OZ-4120-12	OZ-4122-12	–	–
13 cm – 5"	OZ-4120-13	OZ-4122-13	–	OZ-4126-13
14,5 cm – 5¾"	OZ-4120-14	OZ-4122-14	OZ-4123-14	OZ-4126-14
15,5 cm – 6"	OZ-4120-15	–	–	OZ-4126-15
18,5 cm – 7¼"	OZ-4120-18	OZ-4122-18	–	–
21 cm – 8¼"	OZ-4120-21	OZ-4122-21	–	–
25 cm – 10"	OZ-4120-25	OZ-4122-25	–	–
31 cm – 12¼"	OZ-4120-31	OZ-4122-31	–	–



Chirurgische Pinzetten Tissue Forceps



3,5 mm



1 : 2 Zähne
1 : 2 teeth

gerade
straight

13 cm – 5"

OZ-4128-13

TREVES



2,5 mm



1 : 2 Zähne
1 : 2 teeth

gerade,
kreuzgerieft
straight,
cross serrated

15 cm – 6"	OZ-4224-15
20 cm – 8"	OZ-4224-20

**STRASSBURGER MODELL
STRASBOURG PATTERN**

3,5 mm



1 : 2 Zähne
1 : 2 teeth

gerade
straight

3,5 mm



2 : 3 Zähne
2 : 3 teeth

gerade
straight

18 cm – 7"

OZ-4225-18	OZ-4225-28
-------------------	-------------------

FERRIS-SMITH



3,5 mm



2 : 3 Zähne
2 : 3 teeth

gerade
straight

Typ / Type	18 cm – 7"
TC	OZ-4225-52

FERRIS-SMITH



Chirurgische Pinzetten Tissue Forceps



LANE

14,5 cm – 5¾"	OZ-4226-14	OZ-4227-14
20 cm – 8"	OZ-4226-20	OZ-4227-20



STILLE-BARRAYA

18 cm – 7"	OZ-4228-18
20 cm – 8"	OZ-4228-20
25 cm – 10"	OZ-4228-25



4 mm
1 : 2 Zähne
1 : 2 teeth

gerade
straight



4,5 mm
2 : 3 Zähne
2 : 3 teeth

gerade
straight



3 mm
3 : 4 Zähne
3 : 4 teeth

gerade,
kreuzgerieft
straight,
cross serrated



BONNEY

	OZ-4229-18	OZ-4230-18
--	-------------------	-------------------



NEW ORLEANS

15 cm – 6"	OZ-4144-15	OZ-4145-15
20 cm – 8"	OZ-4144-20	OZ-4145-20
25 cm – 10"	OZ-4144-25	OZ-4145-25



4 mm
1 : 2 Zähne
1 : 2 teeth



4 mm
2 : 3 Zähne
2 : 3 teeth



2,5 mm
2 : 3 Zähne
2 : 3 teeth

gerade
straight



4,0 mm
4 : 5 Zähne
4 : 5 teeth

gerade
straight



Hautpinzetten Skin Forceps



O

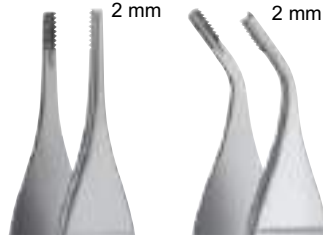
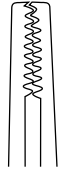

gerade
straight

gebogen
curved

12 cm – 4¾"	OZ-4137-12	OZ-4137-72
15 cm – 6"	OZ-4137-15	–

ADSON-BROWN



gerade
straight

Typ / Type	12 cm – 4¾"
TC	OZ-4137-62

ADSON-BROWN



gerade
straight

15 cm – 6"
OZ-4026-15

COTTLE



gerade
straight

15 cm – 6"	OZ-4139-15
20 cm – 6"	OZ-4139-20
25 cm – 10"	OZ-4139-25

BROWN



gerade
straight

12 cm – 4¾"
OZ-4137-82

ADSON-GRAEFE



OZZE MEDICAL & SURGICAL SUPPLIES
TOOLS TO OPERATE

Darm- und Lungenpinzetten Intestinal and Lung Forceps

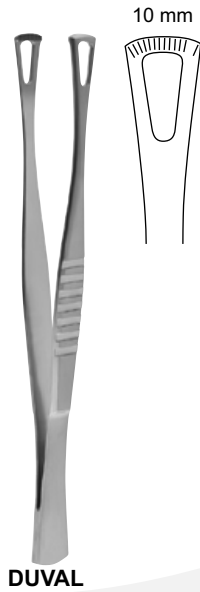

gerade
straight

14,5 cm – 5¾"

OZ-4215-14

DUVAL

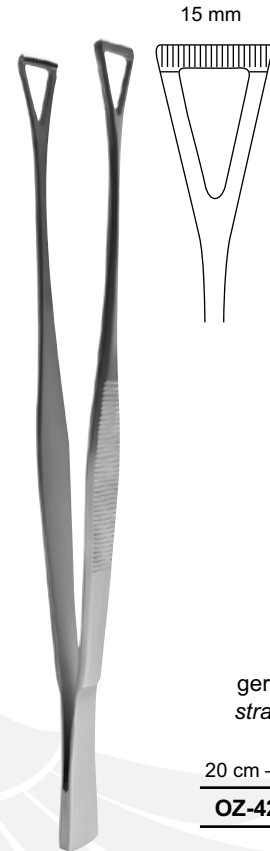

gerade
straight

20 cm – 8"

OZ-4216-20

COLLIN-DUVAL



7 mm

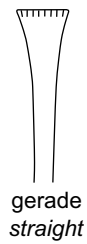

gerade
straight

15 cm – 6" | **OZ-4235-15**

18 cm – 7" | **OZ-4235-18**

23 cm – 9" | **OZ-4235-23**

NELSON

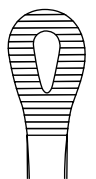

gerade
straight

18 cm – 7" | **OZ-4236-18**

23 cm – 9" | **OZ-4236-23**

SINGLEY-TUTTLE



OZZE MEDICAL & SURGICAL SUPPLIES
TOOLS TO OPERATE

Fasspinzetten Grasping Forceps



DURANTE



gerade
straight

14,5 cm – 5¾"	OZ-4219-14
16 cm – 6¼"	OZ-4219-16
20 cm – 8"	OZ-4219-20



**RUSSISCHES MODELL
RUSSIAN PATTERN**



gerade
straight

15 cm – 6"	OZ-4220-15
20 cm – 8"	OZ-4220-20
25 cm – 10"	OZ-4220-25



MAYO



gerade
straight

23 cm – 9"	OZ-4221-23
------------	-------------------



Splitterpinzetten Splinter Forceps



gerade, glatt
straight, smooth



gebogen, glatt
curved, smooth



gerade
straight



gebogen
curved

8 cm – 3¼"	OZ-4290-08	OZ-4291-08	OZ-4292-08	OZ-4293-08
9 cm – 3½"	OZ-4290-09	OZ-4291-09	OZ-4292-09	OZ-4293-09
10,5 cm – 4¼"	OZ-4290-10	OZ-4291-10	OZ-4292-10	OZ-4293-10
11,5 cm – 4½"	OZ-4290-11	OZ-4291-11	OZ-4292-11	OZ-4293-11
12,5 cm – 5"	OZ-4290-12	OZ-4291-12	OZ-4292-12	OZ-4293-12
14,5 cm – 5¾"	–	–	OZ-4270-05	OZ-4270-15

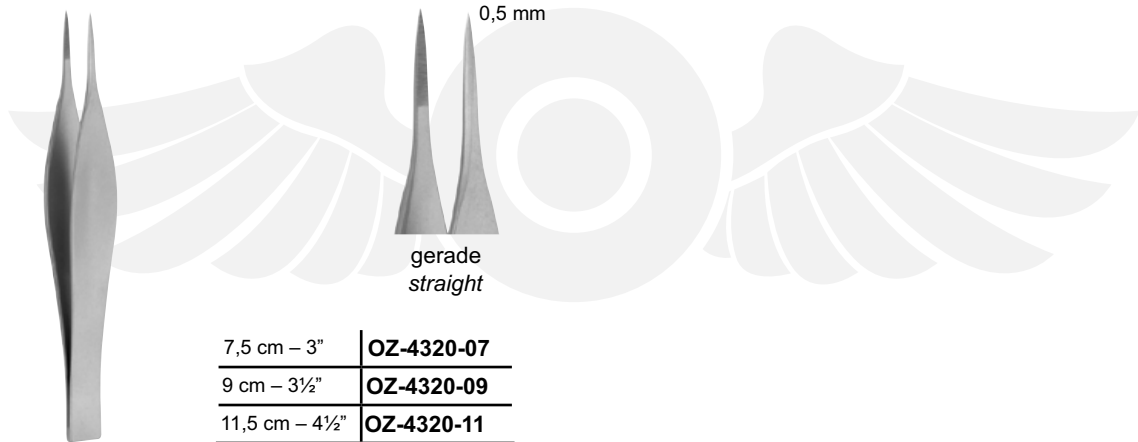

gerade
straight

7,5 cm – 3"	OZ-4320-07
9 cm – 3½"	OZ-4320-09
11,5 cm – 4½"	OZ-4320-11

FEILCHENFELD



HUNTER



gerade
straight



gebogen
curved

10,5 cm – 4¼"

OZ-4340-10	OZ-4341-10
-------------------	-------------------



WALTER-CARMALT



gerade
straight



gebogen
curved

10,5 cm – 4¼"

OZ-4350-10	OZ-4351-10
-------------------	-------------------



Splitterzangen Splinter Forceps

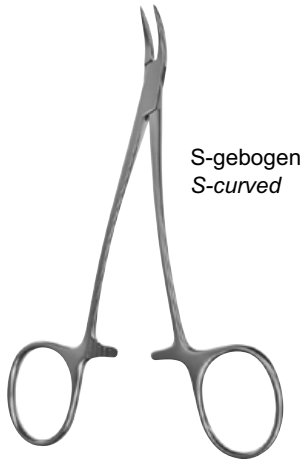

S-gebogen
S-curved

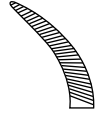

11 cm – 4¼"

OZ-4358-11

PEET



STIEGLITZ

gerade,
ohne Sperre
straight,
without ratchet

gerade,
mit Sperre
straight, with
ratchet



gebogen,
ohne Sperre
curved,
without ratchet

gebogen,
mit Sperre
curved, with
ratchet

13,5 cm – 5¼"

OZ-4359-13

OZ-4360-13

OZ-4362-13

OZ-4361-13



RALK

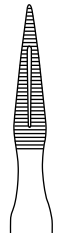

gerade
straight

15 cm – 6"

OZ-4364-15



RALK

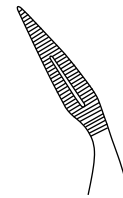

abgewinkelt 45°
angled 45°

15 cm – 6"

OZ-4365-15



Cilienpinzetten Cilia Forceps

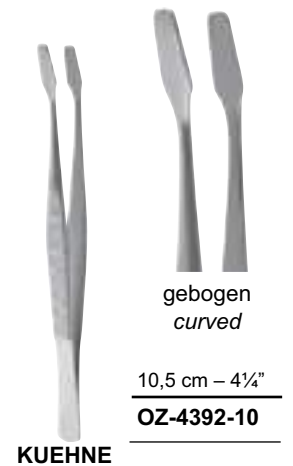
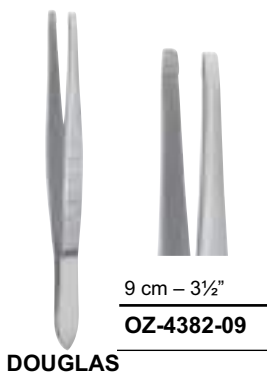
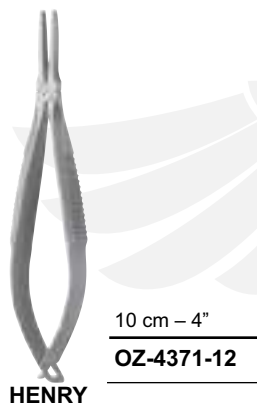
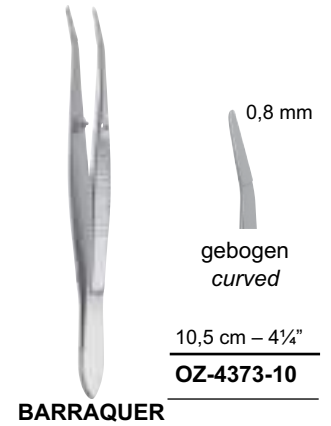
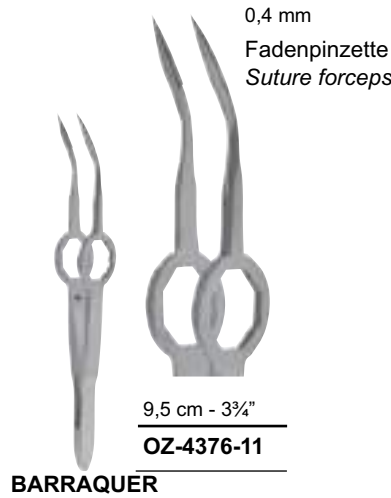



©ZZE MEDICAL & SURGICAL SUPPLIES

TOOLS TO OPERATE

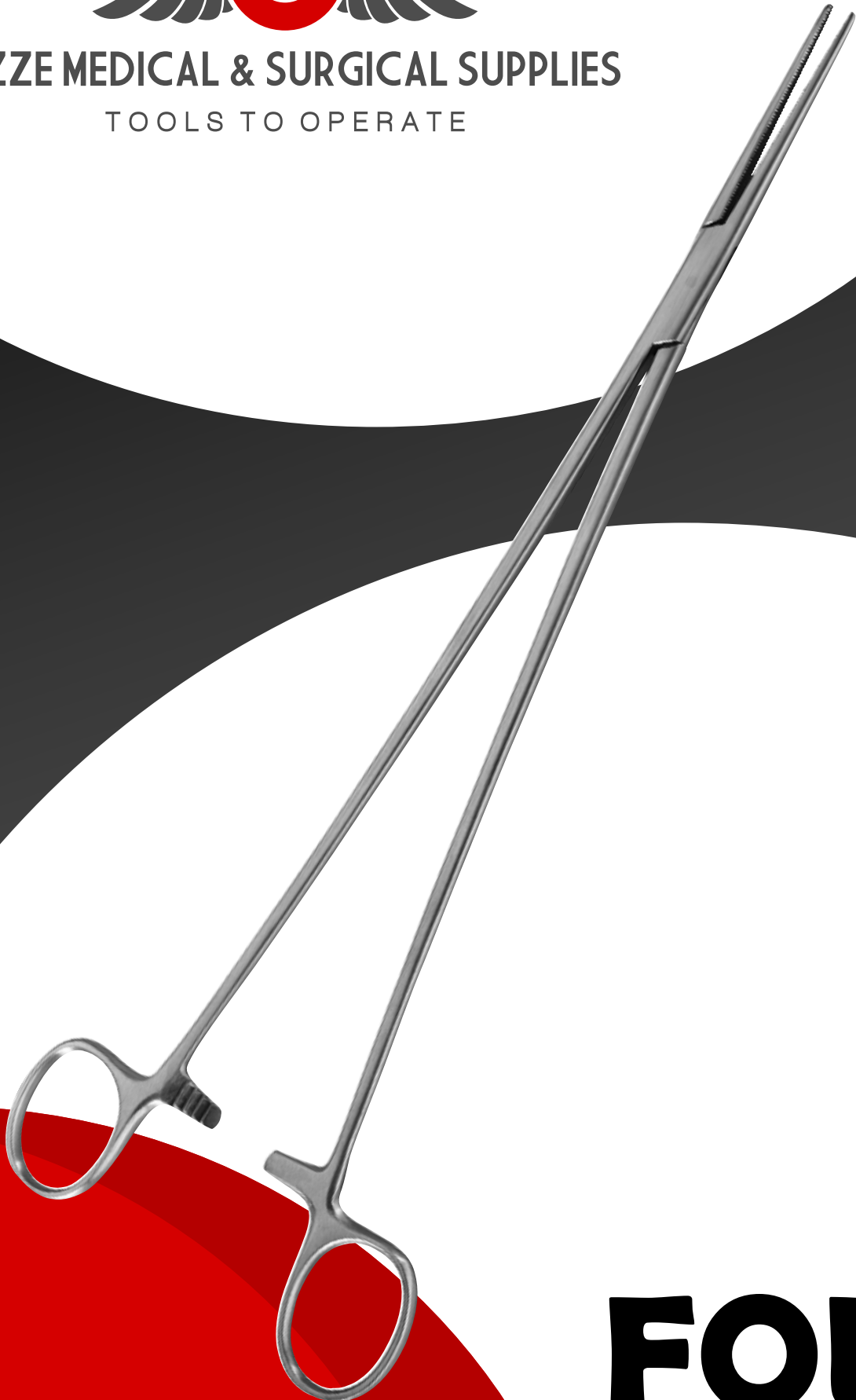

FOUR

🖱 www.ozzesurgical.com.au

✉ info@ozzesurgical.com.au



Klemmen und Zangen



Clamps and Forceps

Arterienklemmen	<i>Hemostatic forceps</i>	CF 1 - 25
Ligaturklemmen	<i>Ligature Forceps</i>	CF 26 - 39
Klemmzangen	<i>Clamp Forceps</i>	CF 40 - 41
Peritoneumklemmen	<i>Peritoneal Forceps</i>	CF 42 - 44
Tuchklemmen	<i>Towel Forceps</i>	CF 45 - 48
Schlauchklemmen	<i>Tubing Forceps</i>	CF 49 - 50
Kornzangen	<i>Dressing Forceps</i>	CF 51 - 53
Tupferzangen	<i>Cotton Swab Forceps</i>	CF 54 - 55
Schwammzangen	<i>Sponge Holding Forceps</i>	CF 56 - 57
Bulldogklemmen	<i>Bulldog Clamps</i>	CF 58 - 61

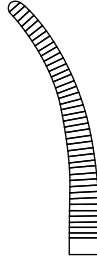

Arterienklemmen Hemostatic Forceps

			
gerade straight	gebogen curved	gerade straight	gebogen curved
13 cm – 5"		14 cm – 5½"	
OZ-3000-13	OZ-3001-13	OZ-3000-14	OZ-3001-14

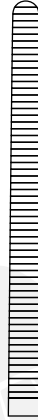
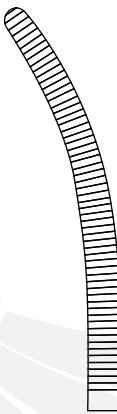
			
gerade straight	gebogen curved	gerade straight	gebogen curved
16 cm – 6¼"		18 cm – 7"	
OZ-3000-16	OZ-3001-16	OZ-3000-18	OZ-3001-18

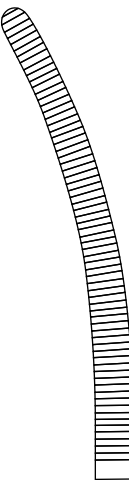
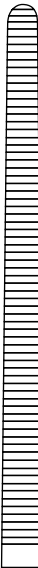
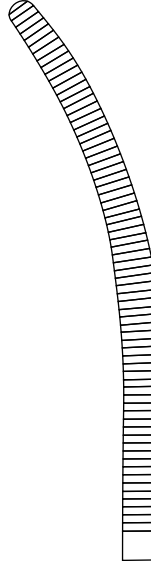

ROCHESTER-PEAN

			
gerade straight	gebogen curved	gerade straight	gebogen curved
20 cm – 8"		22 cm – 8¾"	
OZ-3000-20	OZ-3001-20	OZ-3000-22	OZ-3001-22



Arterienklemmen Hemostatic Forceps



ROCHESTER-PEAN

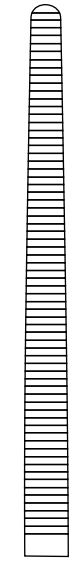

gerade
straight

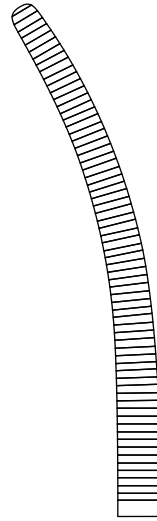

gebogen
curved



gerade
straight

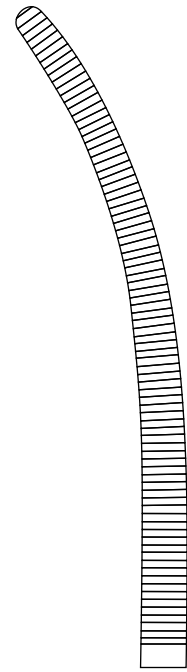

gebogen
curved

24 cm – 9½"

26 cm – 10¼"

OZ-3000-24

OZ-3001-24

OZ-3000-26

OZ-3001-26



ROCHESTER-PEAN



gerade
straight

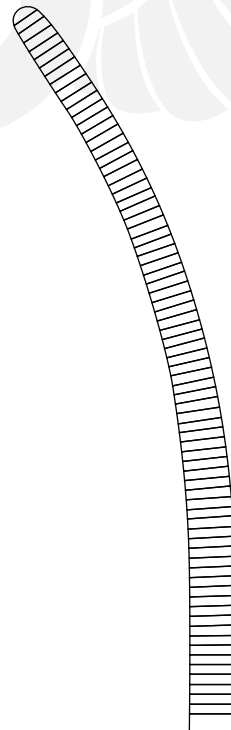

gebogen
curved

30 cm – 11¾"

OZ-3000-30

OZ-3001-30



Arterienklemmen Hemostatic Forceps



gerade
straight

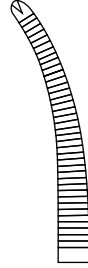

gebogen
curved

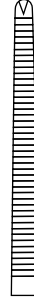

gerade
straight



gebogen
curved

13 cm – 5"

14 cm – 5½"

OZ-3010-13	OZ-3011-13	OZ-3010-14	OZ-3011-14
-------------------	-------------------	-------------------	-------------------



1 : 2 Zähne
1 : 2 teeth



OCHSNER-KOCHER

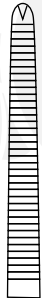

gerade
straight

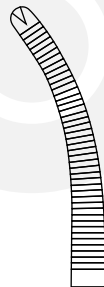

gebogen
curved



gerade
straight



gebogen
curved

16 cm – 6¼"

18 cm – 7"

OZ-3010-16	OZ-3011-16	OZ-3010-18	OZ-3011-18
-------------------	-------------------	-------------------	-------------------



Arterienklemmen Hemostatic Forceps



1 : 2 Zähne
1 : 2 teeth

OCHSNER-KOCHER



gerade
straight

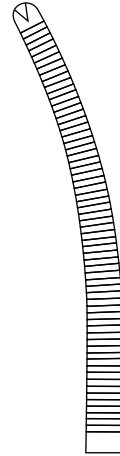

gebogen
curved



gerade
straight

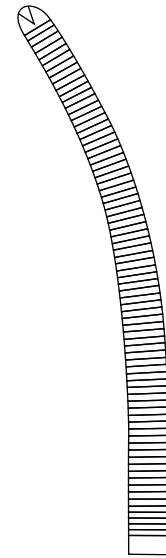

gebogen
curved

20 cm – 8"

22 cm – 8¾"

OZ-3010-20

OZ-3011-20

OZ-3010-22

OZ-3011-22



1 : 2 Zähne
1 : 2 teeth

OCHSNER-KOCHER



gerade
straight

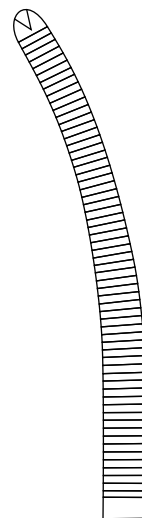

gebogen
curved



gerade
straight

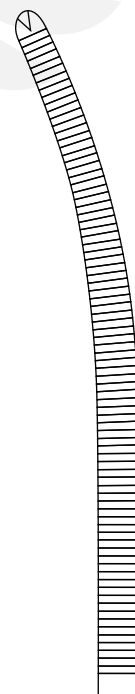

gebogen
curved

24 cm – 9½"

26 cm – 10¼"

OZ-3010-24

OZ-3011-24

OZ-3010-26

OZ-3011-26



OZZE MEDICAL & SURGICAL SUPPLIES
TOOLS TO OPERATE

Arterienklemmen Hemostatic Forceps

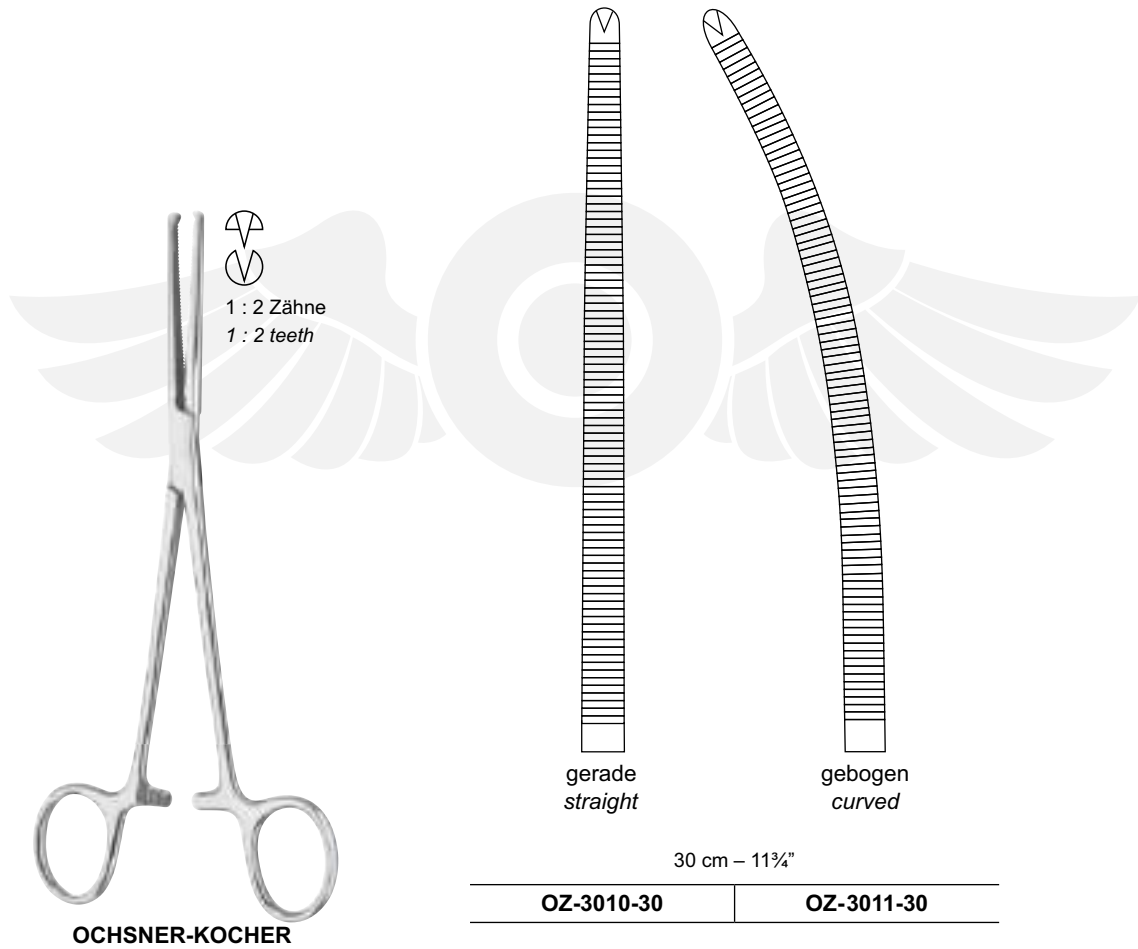







OZZE MEDICAL & SURGICAL SUPPLIES
TOOLS TO OPERATE

Arterienklemmen Hemostatic Forceps

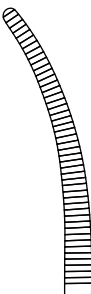

PEAN

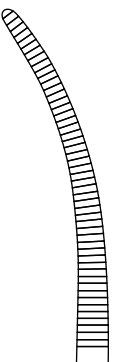



					
gerade straight	gebogen curved	gerade straight	gebogen curved	gerade straight	gebogen curved
13 cm – 5"		14 cm – 5½"		16 cm – 6¼"	
OZ-3020-13	OZ-3021-13	OZ-3020-14	OZ-3021-14	OZ-3020-16	OZ-3021-16



KOCHER

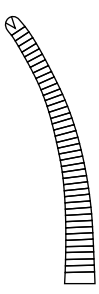

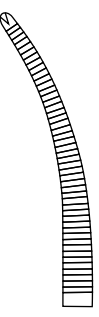
1 : 2 Zähne
1 : 2 teeth

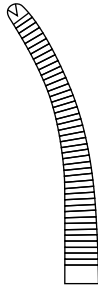
					
gerade straight	gebogen curved	gerade straight	gebogen curved	gerade straight	gebogen curved
13 cm – 5"		14 cm – 5½"		16 cm – 6¼"	
OZ-3030-13	OZ-3031-13	OZ-3030-14	OZ-3031-14	OZ-3030-16	OZ-3031-16



OZZE MEDICAL & SURGICAL SUPPLIES
TOOLS TO OPERATE

Arterienklemmen Hemostatic Forceps



KELLY

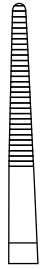

gerade
straight

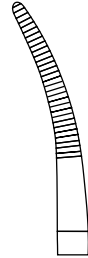

gebogen
curved

14,5 cm – 5¾"

OZ-3050-14

OZ-3051-14



KELLY-RANKIN



gerade
straight



gebogen
curved

16 cm – 6¼"

OZ-3050-16

OZ-3051-16



Arterienklemmen Hemostatic Forceps



CRILE

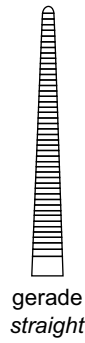

gerade
straight



gebogen
curved



gerade
straight

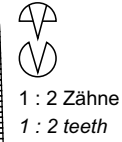

1 : 2 Zähne
1 : 2 teeth

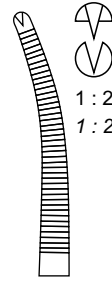

gebogen
curved

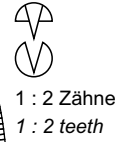

1 : 2 Zähne
1 : 2 teeth

14,5 cm – 5¾"

OZ-3070-14	OZ-3071-14	OZ-3074-14	OZ-3075-14
-------------------	-------------------	-------------------	-------------------



CRILE-RANKIN

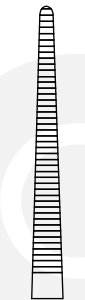

gerade
straight



gebogen
curved

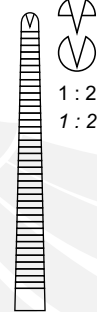

gerade
straight



1 : 2 Zähne
1 : 2 teeth

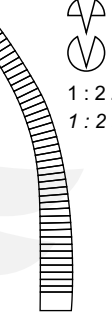

gebogen
curved

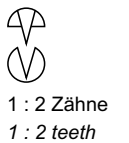

1 : 2 Zähne
1 : 2 teeth

16 cm – 6¼"

OZ-3070-16	OZ-3071-16	OZ-3074-16	OZ-3075-16
-------------------	-------------------	-------------------	-------------------



BABY-CRILE

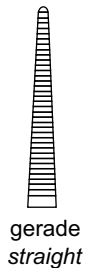

gerade
straight



gebogen
curved

14,5 cm – 5¾"

OZ-3072-14	OZ-3073-14
-------------------	-------------------



BABY-CRILE



1 : 2 Zähne
1 : 2 teeth



gerade
straight

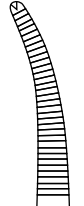

gebogen
curved

14,5 cm – 5¾"

OZ-3076-14	OZ-3077-14
-------------------	-------------------



Arterienklemmen Hemostatic Forceps



COLLER-CRILE

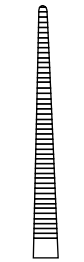

gerade
straight

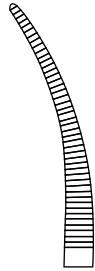

gebogen
curved



gerade
straight

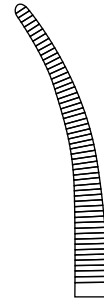

gebogen
curved

14 cm – 5½"

16 cm – 6¼"

OZ-3078-14

OZ-3079-14

OZ-3078-16

OZ-3079-16



COLLER-CRILE

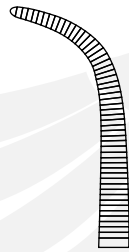

gebogen
curved

16 cm – 6¼"

OZ-3979-36



LERICHE



gerade
straight



gebogen
curved

15 cm – 6"

OZ-3080-15

OZ-3081-15

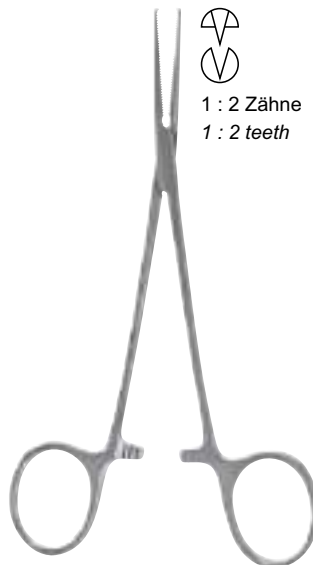

LERICHE



1 : 2 Zähne
1 : 2 teeth

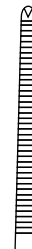

gerade
straight



gebogen
curved

15 cm – 6"

OZ-3082-15

OZ-3083-15



Arterienklemmen Hemostatic Forceps



PROVIDENCE



gerade
straight



gebogen
curved

14,5 cm – 5¾"

OZ-3090-14 | **OZ-3091-14**



Ligaturklemme
Ligature forceps



gerade, glatt
straight, smooth

9,5 cm – 3¾"

OZ-3097-09

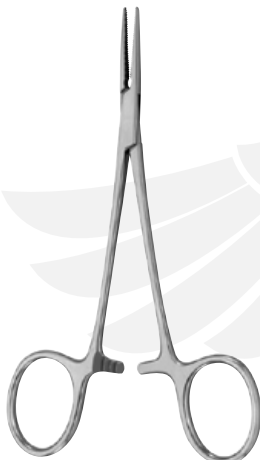

HALSTED-MOSQUITO



gerade
straight



gebogen
curved

12,5 cm – 5"

OZ-3100-12 | **OZ-3101-12**

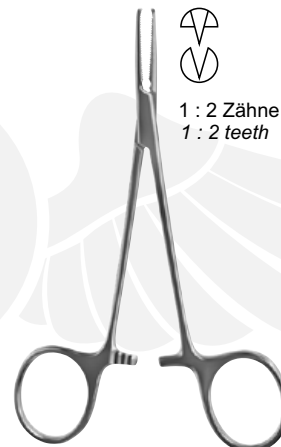

HALSTED-MOSQUITO



1 : 2 Zähne
1 : 2 teeth



gerade
straight



gebogen
curved

12,5 cm – 5"

OZ-3110-12 | **OZ-3111-12**



HALSTED-MOSQUITO

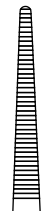

gerade
straight



gebogen
curved

14 cm – 5½"

OZ-3100-14 | **OZ-3101-14**



HALSTED-MOSQUITO



1 : 2 Zähne
1 : 2 teeth



gerade
straight

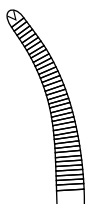

gebogen
curved

14 cm – 5½"

OZ-3110-14 | **OZ-3111-14**



Arterienklemmen Hemostatic Forceps



HALSTED-MOSQUITO



gerade
straight



gebogen
curved

18 cm – 7"

OZ-3100-18

OZ-3101-18



gerade
straight

1 : 2 Zähne
1 : 2 teeth



gebogen
curved

1 : 2 Zähne
1 : 2 teeth

18 cm – 7"

OZ-3110-18

OZ-3111-18



HALSTED-MOSQUITO



gerade
straight

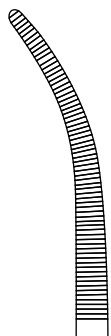

gebogen
curved

21 cm – 8¼"

OZ-3100-21

OZ-3101-21



gerade
straight

1 : 2 Zähne
1 : 2 teeth



gebogen
curved

1 : 2 Zähne
1 : 2 teeth

21 cm – 8¼"

OZ-3110-21

OZ-3111-21



Arterienklemmen Hemostatic Forceps



JACOBSON

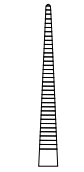

gerade
straight



gebogen
curved

13 cm – 5"

OZ-3114-13

OZ-3115-13



MICRO-MOSQUITO



gerade
straight



gebogen
curved

10 cm – 4"

OZ-3120-10

OZ-3121-10



gerade
straight



gebogen
curved

1 : 2 Zähne
1 : 2 teeth



1 : 2 Zähne
1 : 2 teeth

10 cm – 4"

OZ-3122-10

OZ-3123-10

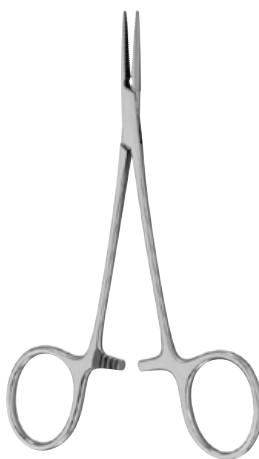

MICRO-MOSQUITO

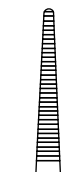

gerade
straight

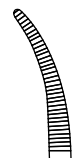

gebogen
curved

12,5 cm – 5"

OZ-3120-12

OZ-3121-12



gerade
straight



gebogen
curved

1 : 2 Zähne
1 : 2 teeth



1 : 2 Zähne
1 : 2 teeth

12,5 cm – 5"

OZ-3122-12

OZ-3123-12

Arterienklemmen Hemostatic Forceps

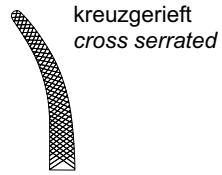

kreuzgerieft
 cross serrated

gebogen
 curved

12 cm – 4¾"

OZ-3137-12



HARTMANN



gerade
 straight



gebogen
 curved

10 cm – 4"

OZ-3140-10

OZ-3141-10



gerade
 straight

1 : 2 Zähne
 1 : 2 teeth



gebogen
 curved

1 : 2 Zähne
 1 : 2 teeth

10 cm – 4"

OZ-3142-10

OZ-3143-10



CARREL



gerade
 straight

10 cm – 4"

OZ-3147-10



CHAPUT



gerade
 straight

13 cm – 5"

OZ-3148-13



2 : 3 Zähne
 2 : 3 teeth



Arterienklemmen Hemostatic Forceps

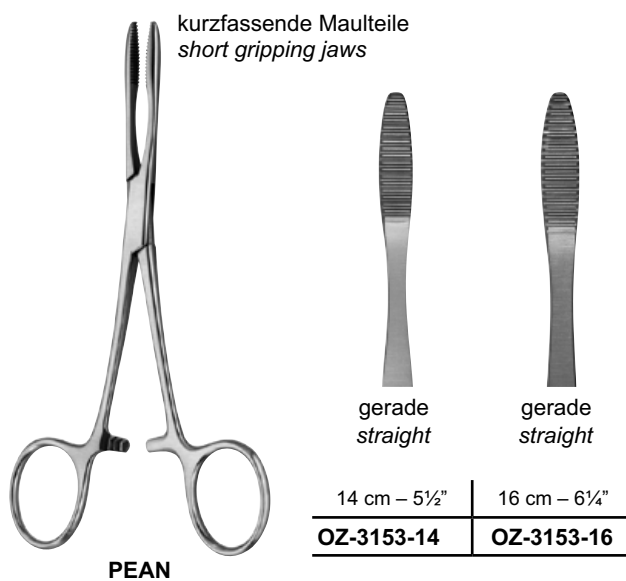
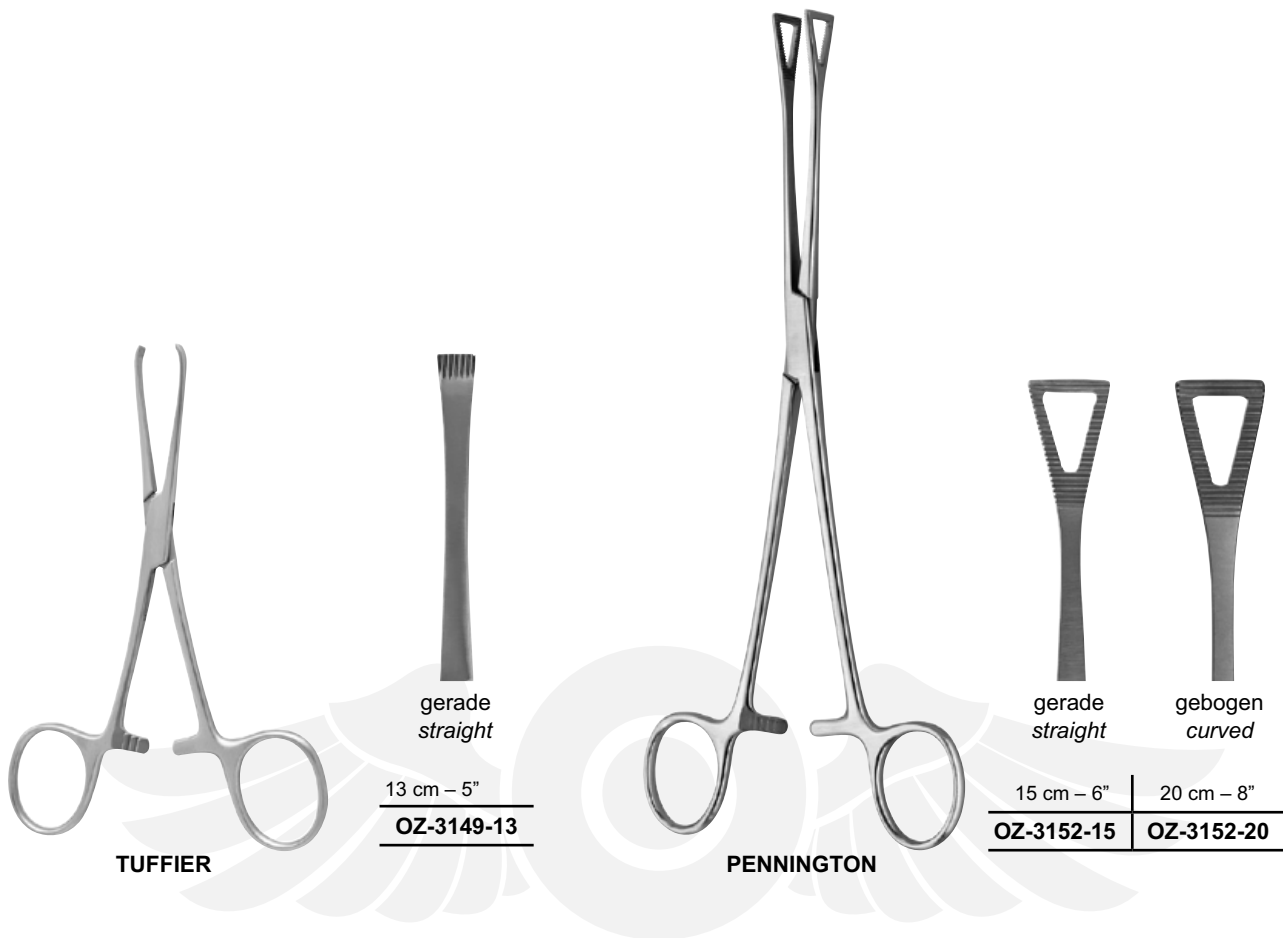



Arterienklemmen Hemostatic Forceps



COLLIN



gerade
straight

15,5 cm – 6"

OZ-3155-16



COLLIN



gerade
straight

14 cm – 5½"

OZ-3156-14



COLLIN



gerade
straight

16,5 cm – 6½"

OZ-3157-16



DUNHILL



gebogen
curved

13 cm – 5"

OZ-3159-13



OZZE MEDICAL & SURGICAL SUPPLIES
TOOLS TO OPERATE

Arterienklemmen Hemostatic Forceps



CAIRNS



gerade
straight



gebogen
curved

15 cm – 6"

OZ-3162-15 | **OZ-3163-15**



MOYNIHAN



seitlich gebogen
curved sideways

13,5 cm – 5¼"

OZ-3164-01



MOYNIHAN



gebogen
curved

15 cm – 6"

OZ-3164-02



OZZE MEDICAL & SURGICAL SUPPLIES
TOOLS TO OPERATE

Arterienklemmen Hemostatic Forceps



1 : 2 Zähne
1 : 2 teeth



seitlich gebogen
curved sideways

18 cm – 7"

OZ-3165-18



1 : 2 Zähne
1 : 2 teeth

seitlich gebogen
curved sideways

12,5 cm – 5"

OZ-3166-13

RAIMONDI



HOEN



seitlich gebogen
curved sideways

14 cm – 5½"

OZ-3167-13



Arterienklemmen Hemostatic Forceps



ROCHESTER-CARMALT



gerade
straight



gebogen
curved



gerade
straight



gebogen
curved

16 cm – 6¼"

20 cm – 8"

OZ-3170-16	OZ-3171-16	OZ-3170-20	OZ-3171-20
-------------------	-------------------	-------------------	-------------------



MOSQUITO-DANDY



seitlich gebogen
curved sideways



kreuzgerieft
cross serrated

12 cm – 4¾"

OZ-3179-12	OZ-3181-12
-------------------	-------------------



DANDY



seitlich gebogen
curved sideways



1 : 2 Zähne
1 : 2 teeth

14 cm – 5½"

OZ-3182-14	OZ-3183-14
-------------------	-------------------

Arterienklemmen Hemostatic Forceps



LOVELACE



15,5 cm – 6"
OZ-3185-15



DIXON-LOVELACE

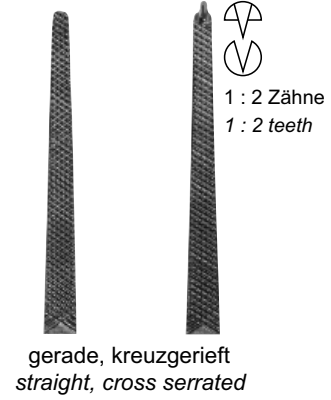

16 cm – 6¼"
OZ-3186-16 | **OZ-3187-16**



BAINBRIDGE



15 cm – 6"		18 cm – 7"	
OZ-3190-15	OZ-191-15	OZ-3190-18	OZ-3191-18



Arterienklemmen Hemostatic Forceps



FUCHSIG



gebogen
curved

19 cm – 7½"

OZ-3198-19



ADSON



gerade
straight

18,5 cm – 7¼"

OZ-3200-18



gebogen
curved

OZ-3201-18



NISSEN



gebogen
curved

18,5 cm – 7¼" | 22 cm – 8¾"

OZ-3204-18

OZ-3204-22



leicht gebogen
slightly curved

14 cm – 5½"

OZ-3205-14



BABY-ADSON



stark gebogen
strongly curved

18 cm – 7"

OZ-3205-18

Arterienklemmen Hemostatic Forceps



gerade
 straight



gebogen
 curved

20 cm – 8"

OZ-3240-20

OZ-3241-20



gerade
 straight

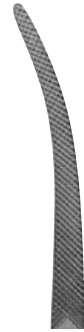

gebogen
 curved

22 cm – 8¾"

OZ-3240-22

OZ-3241-22



kreuzgerieft
 cross serrated

BENGOLEA



gerade
 straight



gebogen
 curved

24 cm – 9½"

OZ-3240-24

OZ-3241-24



gerade
 straight



gebogen
 curved

26 cm – 10¼"

OZ-3240-26

OZ-3241-26



Arterienklemmen Hemostatic Forceps



BIRKETT

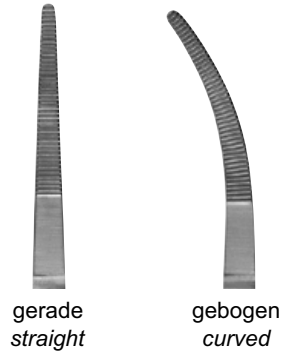

gerade
straight

gebogen
curved

19 cm – 7½"

OZ-3210-19

OZ-3211-19



ROBERTS

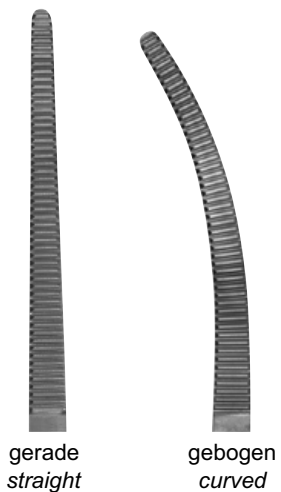

gerade
straight

gebogen
curved

22 cm – 8¾"

OZ-3250-22

OZ-3251-22

Arterienklemmen Hemostatic Forceps

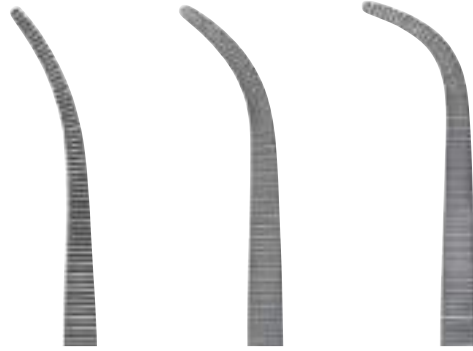

gebogen *curved* leicht gebogen *slightly curved* stark gebogen *strongly curved*

19 cm – 7½"

OZ-3253-41	OZ-3253-42	OZ-3253-43
-------------------	-------------------	-------------------

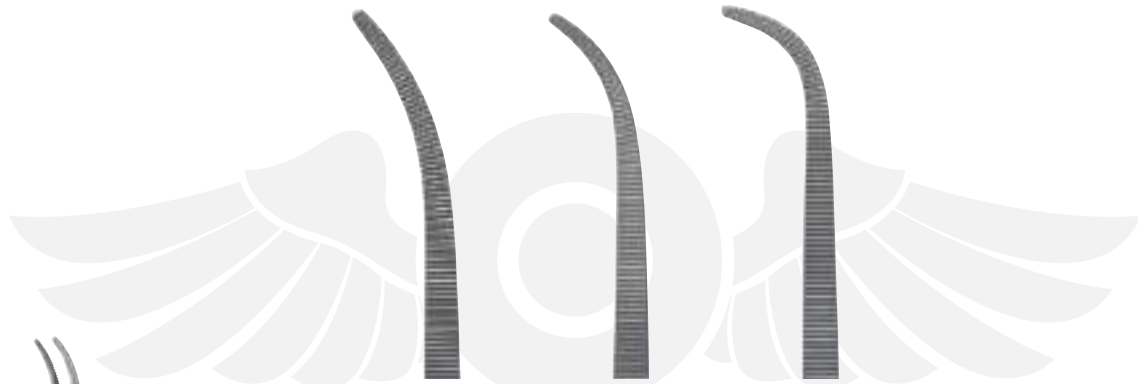

gebogen *curved* leicht gebogen *slightly curved* stark gebogen *strongly curved*

22 cm – 8¾"

OZ-3253-61	OZ-3253-62	OZ-3253-63
-------------------	-------------------	-------------------



gebogen *curved* leicht gebogen *slightly curved* stark gebogen *strongly curved*

24 cm – 9½"

OZ-3253-71	OZ-3253-72	OZ-3253-73
-------------------	-------------------	-------------------



KELLY

Arterienklemmen Hemostatic Forceps



SAROT

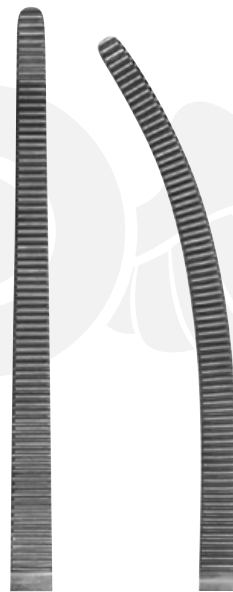

gerade
straight

gebogen
curved

24 cm – 9½"

OZ-3270-24

OZ-3271-24



Arterienklemmen Hemostatic Forceps



CRAFOORD

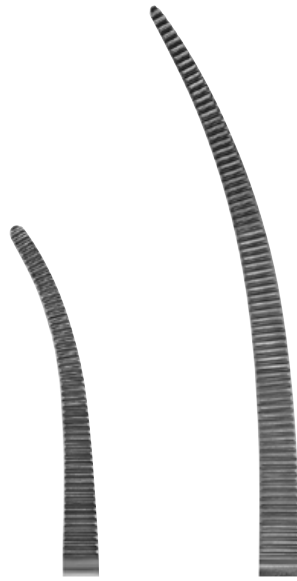

gebogen
curved

18 cm – 7"	24 cm – 9½"
OZ-3275-18	OZ-3275-24



KANTROWITZ

Ligaturklemme
Ligature forceps

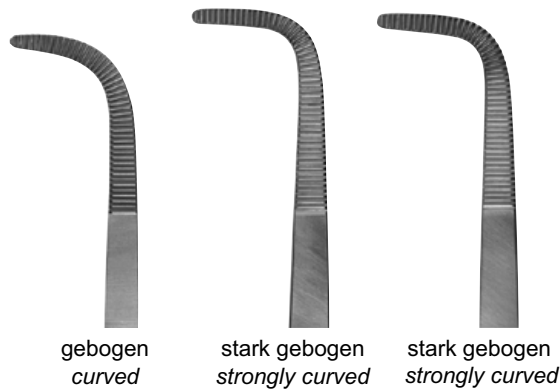

gebogen
curved

stark gebogen
strongly curved

stark gebogen
strongly curved

19 cm – 7½"	24 cm – 9½"	26,5 cm – 10½"
OZ-3279-19	OZ-3279-24	OZ-3279-26



OZZE MEDICAL & SURGICAL SUPPLIES
TOOLS TO OPERATE

Ligaturklemmen Ligature Forceps



JOHNS-HOPKINS



gebogen
curved

20 cm – 8"

OZ-3285-20



RUMEL



gebogen
curved



gebogen
curved



gebogen
curved

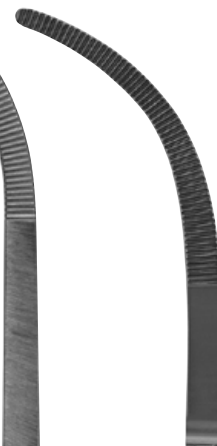

gebogen
curved

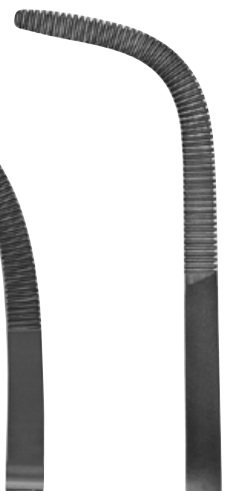

gebogen
curved

23 cm – 9"

OZ-3280-01	OZ-3280-02	OZ-3280-03	OZ-3280-04	OZ-3280-05
-------------------	-------------------	-------------------	-------------------	-------------------



OZZE MEDICAL & SURGICAL SUPPLIES
TOOLS TO OPERATE

Ligaturklemmen Ligature Forceps



ZENKER

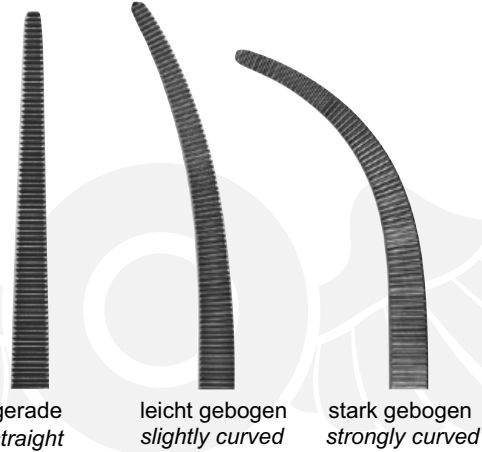

29,5 cm – 11½"

OZ-3286-00

OZ-3286-01

OZ-3286-02



BABY-OVERHOLT



gebogen
curved

13,5 cm – 5¼"

OZ-3289-14



Ligaturklemmen Ligature Forceps

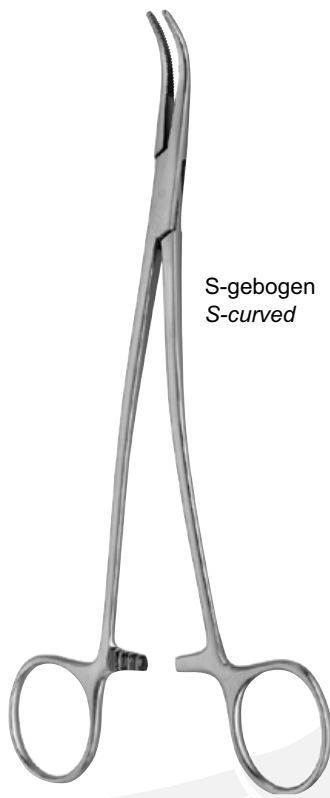

S-gebogen
S-curved

OVERHOLT-SLIM



gebogen
curved

18,5 cm – 7¼"	20,5 cm – 8"	21 cm – 8¼"	21,5 cm – 8½"
OZ-3290-21	OZ-3290-22	OZ-3290-23	OZ-3290-24

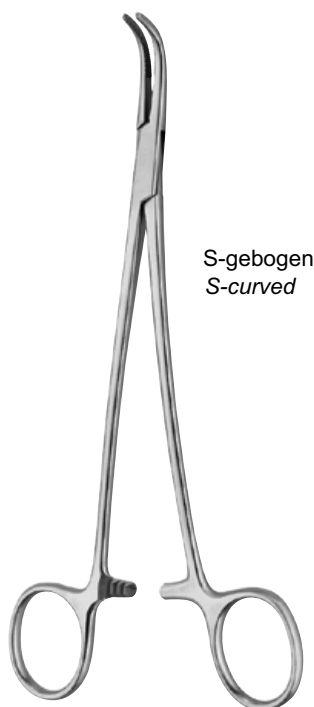

S-gebogen
S-curved

OVERHOLT-S

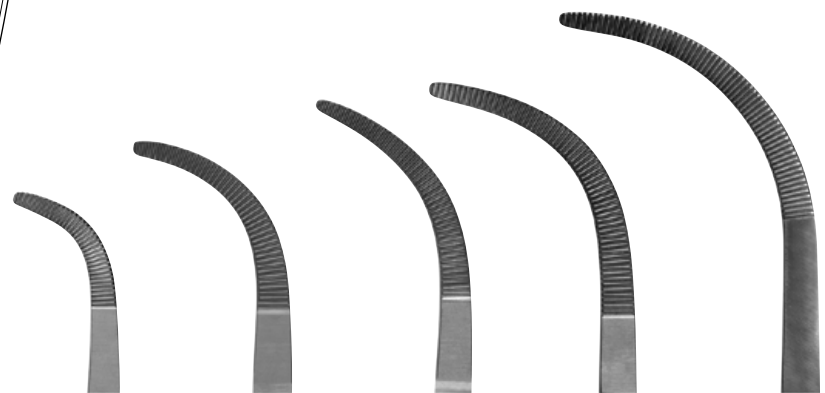

gebogen
curved

18,5 cm – 7¼"	20,5 cm – 8"	21 cm – 8¼"	21,5 cm – 8½"	24 cm – 9½"
OZ-3290-01	OZ-3290-02	OZ-3290-03	OZ-3290-04	OZ-3290-05



Ligaturklemmen Ligature Forceps



OVERHOLT-GEISSENDÖRFER

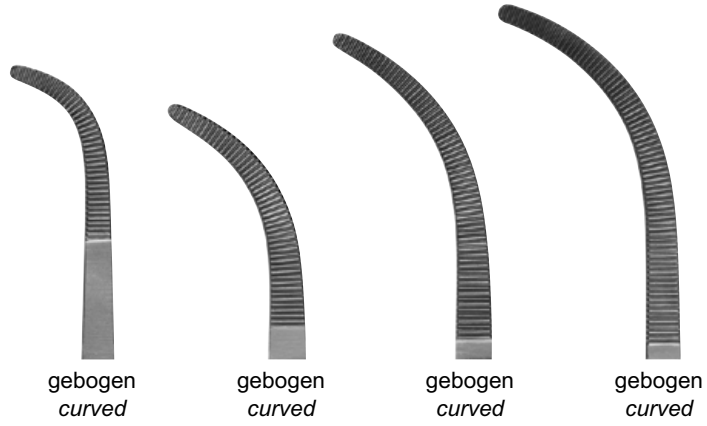

gebogen
curved

gebogen
curved

gebogen
curved

gebogen
curved

21 cm – 8¼"

OZ-3291-21	OZ-3292-21	OZ-3293-21	OZ-294-21
------------	------------	------------	-----------

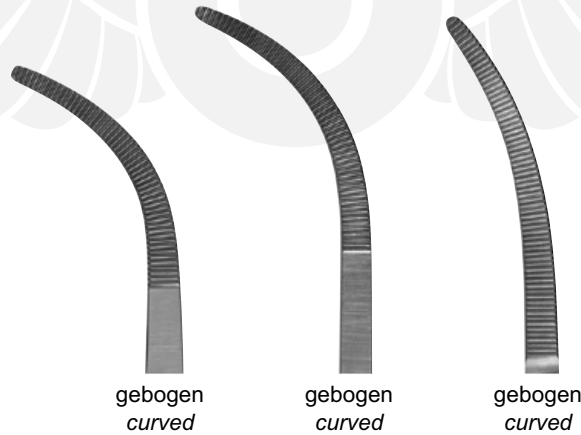

gebogen
curved

gebogen
curved

gebogen
curved

21 cm – 8¼"

OZ-3295-21	OZ-3296-21	OZ-3297-21
------------	------------	------------



Ligaturklemmen Ligature Forceps

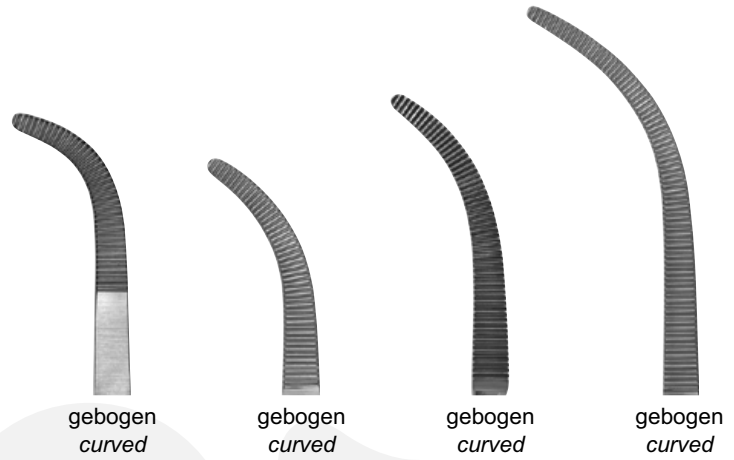

27 cm – 10½"

OZ-3291-27	OZ-3292-27	OZ-3293-27	OZ-3294-27
-------------------	-------------------	-------------------	-------------------

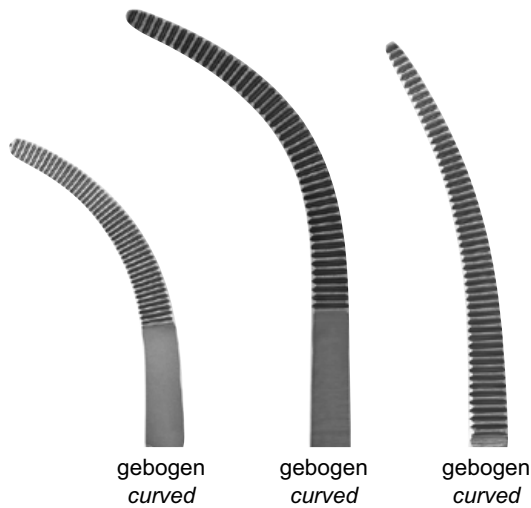

27 cm – 10½"

OZ-3295-27	OZ-3296-27	OZ-3297-27
-------------------	-------------------	-------------------



Ligaturklemmen Ligature Forceps



OVERHOLT-MIXTER



gebogen
curved

21 cm – 8¼"

OZ-3298-21



HEISS



gerade
straight



leicht gebogen
slightly curved



stark gebogen
strongly curved

20 cm – 8"

OZ-3301-20

OZ-3302-20

OZ-3303-20



1 : 2 Zähne
1 : 2 teeth



gerade
straight



gebogen
curved

20 cm – 8"

OZ-3305-20

OZ-3306-20



Ligaturklemmen Ligature Forceps

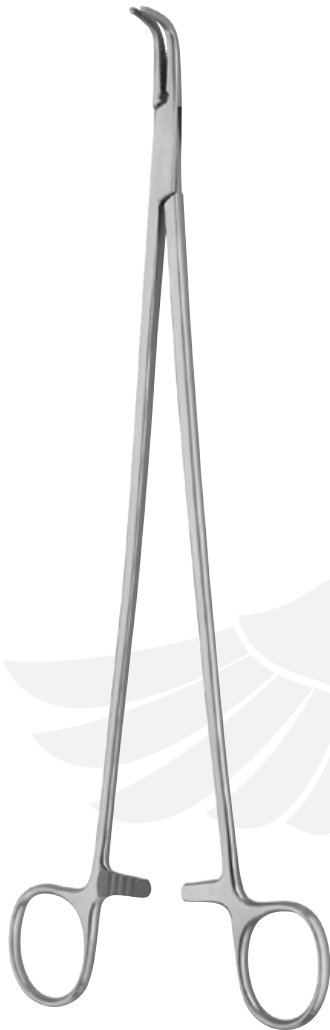

MEEKER

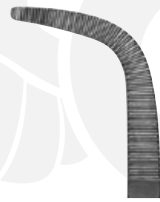

gebogen
curved

27 cm – 10½"

OZ-3308-27



LOWER

Gallenkanalklemme
Gall duct forceps



gebogen
curved

18 cm – 7"

OZ-3325-18



OZZE MEDICAL & SURGICAL SUPPLIES
TOOLS TO OPERATE

Ligaturklemmen Ligature Forceps

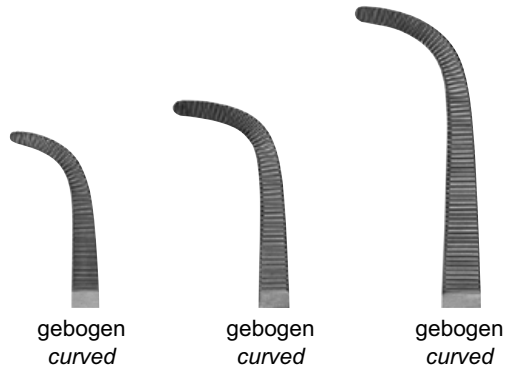

13 cm – 5"	18 cm – 7"	20 cm – 8"
OZ-3326-13	OZ-3326-18	OZ-3326-20



GEMINI

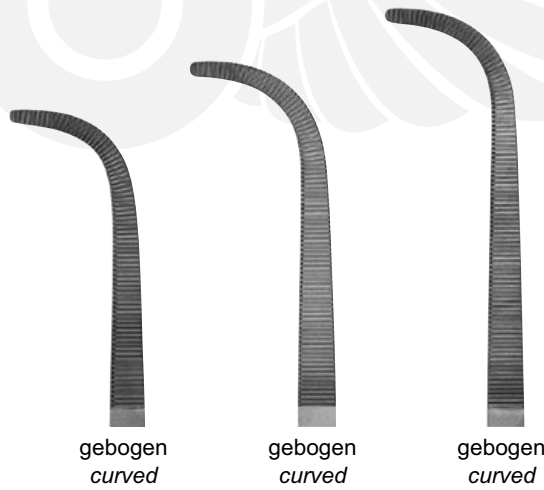

23 cm – 9"	25 cm – 10"	27 cm – 10½"
OZ-3326-23	OZ-3326-25	OZ-3326-27



Ligaturklemmen Ligature Forceps



MINI-GEMINI

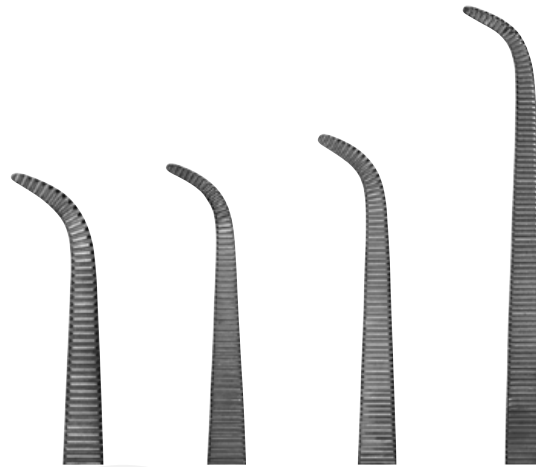

gebogen
curved

18 cm – 7"	22 cm – 8¾"	25 cm – 10"	28 cm – 11"
OZ-3327-18	OZ-3327-22	OZ-3327-25	OZ-3327-28



BABY-MIXTER



gebogen
curved

14 cm – 5½"	14 cm – 5½"	18 cm – 7"
OZ-3328-01	OZ-3328-14	OZ-3328-18

Ligaturklemmen Ligature Forceps

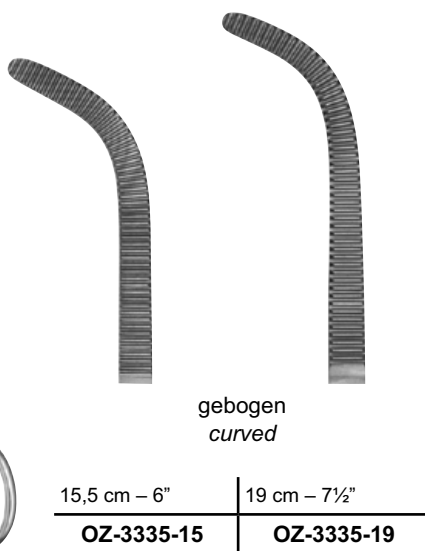
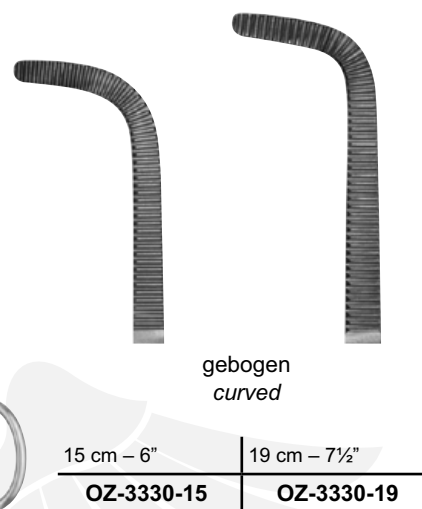
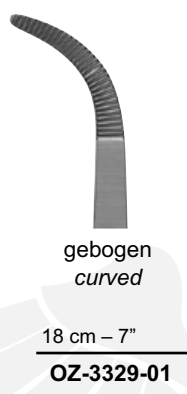



Ligaturklemmen Ligature Forceps



MIXTER-SLIM

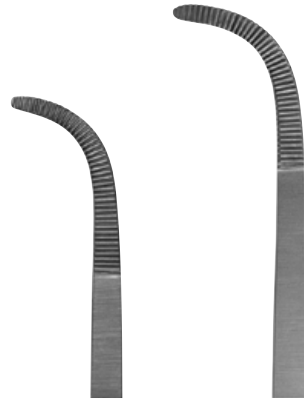

gebogen
curved

18 cm – 7"	23 cm – 9"
OZ-3336-18	OZ-3336-23



MIXTER



gebogen
curved

gebogen
curved

gebogen
curved

22 cm – 8 $\frac{3}{4}$ "	25 cm – 10"	28 cm – 11"
OZ-3341-22	OZ-3342-25	OZ-3343-28



OZZE MEDICAL & SURGICAL SUPPLIES
TOOLS TO OPERATE

Ligaturklemmen Ligature Forceps



MIXTER



gebogen
curved

22 cm – 8¾"

OZ-3350-22



WICKSTROEM

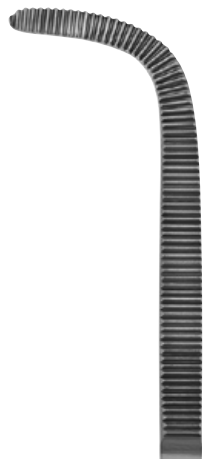

gebogen
curved

20 cm – 8"

OZ-3351-20



FINOCCHIETTO



gebogen
curved

24 cm – 9½"

OZ-3352-24



Ligaturklemmen Ligature Forceps



LAWRENCE



gebogen
curved

27,5 cm – 10¾"

OZ-3355-27



LAHEY



gebogen
curved

19 cm – 7½"

OZ-3361-19

23 cm – 9"

OZ-3361-23



OZZE MEDICAL & SURGICAL SUPPLIES
TOOLS TO OPERATE

Ligaturklemmen Ligature Forceps



gerade
straight



gerade
straight



gerade
straight



gerade
straight



gerade
straight

13 cm – 5"	14 cm – 5½"	15 cm – 6"	18 cm – 7"	20 cm – 8"
OZ-3380-13	OZ-3380-14	OZ-3380-15	OZ-3380-18	OZ-3380-20



SPENCER-WELLS



gebogen
curved



gebogen
curved



gebogen
curved



gebogen
curved



gebogen
curved

13 cm – 5"	14 cm – 5½"	15 cm – 6"	18 cm – 7"	20 cm – 8"
OZ-3381-13	OZ-3381-14	OZ-3381-15	OZ-3381-18	OZ-3381-20



Klemmzangen Clamp Forceps



Tonsillenklemme
Tonsil forceps

NEGUS

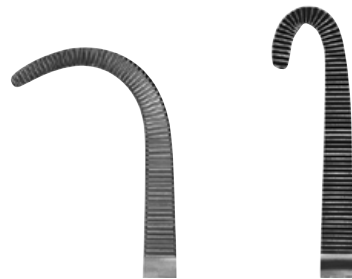

gebogen
curved

19 cm – 7½"

OZ-3387-01 | **OZ-3387-02**



BUIE

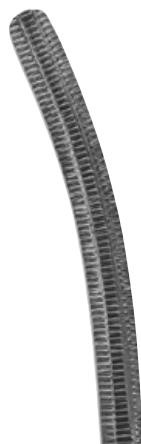

gebogen
curved

21 cm – 8¼"

OZ-3392-21



MAINGOT



1 : 2 Zähne
1 : 2 teeth



gebogen
curved

20,5 cm – 8"

25 cm – 10"

OZ-3394-20

OZ-3394-25



OZZE MEDICAL & SURGICAL SUPPLIES
TOOLS TO OPERATE

Klemmzangen Clamp Forceps



FAURE



gebogen
curved

25 cm – 10"

OZ-3433-45



Peritoneumklemmen Peritoneal Forceps



WERTHEIM



gebogen
curved

18 cm – 7"

OZ-3438-18



BABY-MIKULICZ



1 : 2 Zähne
1 : 2 teeth

gebogen
curved

14 cm – 5½"

OZ-3492-14



BABY-MIKULICZ



1 : 2 Zähne
1 : 2 teeth

gebogen
curved

18,5 cm – 7¼"

OZ-3499-18



MIKULICZ



1 : 2 Zähne
1 : 2 teeth



gebogen
curved

18 cm – 7"

OZ-3500-18

20 cm – 8"

OZ-3500-20



Peritoneumklemmen Peritoneal Forceps



MIKULICZ



1 : 2 Zähne
1 : 2 teeth

gebogen
curved

20 cm – 8"

OZ-3501-20



MIKULICZ



1 : 2 Zähne
1 : 2 teeth

seitlich gebogen
curved sideways

18,5 cm – 7 1/4"

OZ-3502-18



MIKULICZ



1 : 2 Zähne
1 : 2 teeth

gebogen
curved

18 cm – 7"

OZ-3504-18



MIKULICZ



1 : 2 Zähne
1 : 2 teeth



gebogen
curved

20 cm – 8"

OZ-3505-20

OZ-3506-20



Peritoneumklemmen Peritoneal Forceps



1 : 2 Zähne
1 : 2 teeth

FAURE



leicht gebogen
slightly curved



gebogen
curved

20 cm – 8"

OZ-3511-20

OZ-3512-20

Tuchklemmen Towel Forceps

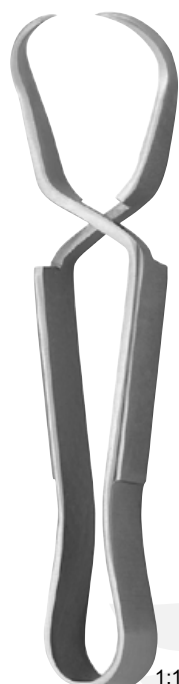

SCHÄDEL

1:1

gebogen
curved

9 cm – 3½"

OZ-3550-09

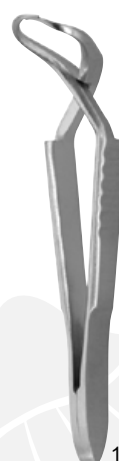

JONES

1:1

gebogen
curved

6 cm – 2½"

OZ-3552-05

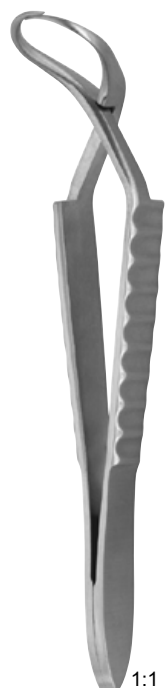

JONES

1:1

gebogen
curved

9 cm – 3½"

OZ-3552-09



ENGLISCHES MODELL
ENGLISH PATTERN

1:1

gebogen
curved

9 cm – 3½"

OZ-3553-09



Tuchklemmen Towel Forceps



BACKHAUS



9 cm – 3½"	OZ-3600-09
11 cm – 4¼"	OZ-3600-11
13 cm – 5"	OZ-3600-13
15 cm – 6"	OZ-3600-15



Tuchklemme
mit Schlauch-
oder Kabelhalter
*Towel forceps
with clip for tubing or
cable*



11 cm – 4¼"	OZ-3602-11
13 cm – 5"	OZ-3602-13



PEERS-BERTRAM



14,5 cm – 5¾"	OZ-3604-14
---------------	-------------------



OZZE MEDICAL & SURGICAL SUPPLIES
TOOLS TO OPERATE

Tuchklemmen Towel Forceps



TOHOKU

10 cm – 4"	OZ-3605-10
13 cm – 5"	OZ-3605-13



Tuchklemme
für Papiertücher
*Towel forceps
for paper tissues*

11 cm – 4¼"	OZ-3617-11
14 cm – 5½"	OZ-3617-13



LORNA

10 cm – 4"	OZ-3618-10
13 cm – 5"	OZ-3618-13





Tuchklemmen Towel Forceps



BERNHARD



16,5 cm – 6½"
OZ-3620-16



LANE



13 cm – 5"

OZ-3622-13



15,5 cm – 6"

OZ-3622-15



20 cm – 8"

OZ-3622-20



Schlauchklemmen Tubing Forceps



15 cm – 6"	18 cm – 7"	20 cm – 8"
OZ-3680-15	OZ-3680-18	OZ-3680-20



14,5 cm – 5¾"
OZ-3682-14



16,5 cm – 6½"	18 cm – 7"
OZ-3684-16	OZ-3684-18



glatt
smooth



Schlauchklemmen Tubing Forceps



Schlauchklemme
mit Schutzbügel
*Tubing forceps with
safety guard*



15 cm – 6"	18 cm – 7"	20 cm – 8"
OZ-3686-15	OZ-3686-18	OZ-3686-20

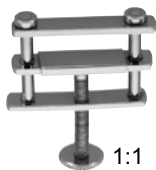

1:1
HOFFMANN

max. Schlauch-Durchmesser- max. tubing diameter	
8 mm	OZ-3692-13
10 mm	OZ-3692-17
12 mm	OZ-3692-20
15 mm	OZ-3692-25
18 mm	OZ-3692-30
25 mm	OZ-3692-40



Kornzangen Dressing Forceps



ULRICH



gerade
straight



gebogen
curved



gerade
straight



gebogen
curved



gerade
straight



gebogen
curved

22 cm – 8¾"

25 cm – 10"

27 cm – 10½"

OZ-3800-22

OZ-3801-22

OZ-3800-25

OZ-3801-25

OZ-3800-27

OZ-3801-27



LISTER

Sinusklemme
Sinus forceps



gerade
straight



gerade
straight



gerade
straight

12,5 cm – 5"

16 cm – 6¼"

18 cm – 7"

OZ-3810-12

OZ-3810-16

OZ-3810-18

Korn-(Polypen) Zange
Dressing and polypus forceps



BRYANT



gebogen
curved

13 cm – 5"

OZ-3812-13



Kornzangen Dressing Forceps



GROSS-MAIER



mit Sperre
with ratchet



ohne Sperre
without ratchet

gerade- straight	gebogen- curved	gerade- straight	gebogen- curved
20 cm – 8"		20 cm – 8"	
OZ-3860-20	OZ-3861-20	OZ-3862-20	OZ-3863-20



GROSS-MAIER

1:3



mit Sperre
with ratchet

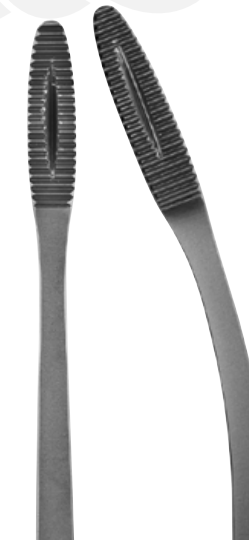

ohne Sperre
without ratchet

gerade- straight	gebogen- curved	gerade- straight	gebogen- curved
25 cm – 10"		25 cm – 10"	
OZ-3860-25	OZ-3861-25	OZ-3862-25	OZ-3863-25



Kornzangen Dressing Forceps



PELKMANN

1:3



gerade
straight



gebogen
curved

25 cm – 10"

OZ-3872-25

OZ-3873-25



SIMS-MAIER

1:3



gerade
straight



gebogen
curved

28 cm – 11"

OZ-3874-28

OZ-3875-28



Tupferzangen Cotton Swab Forceps



COLLIN

1:3



gerade
straight

25 cm – 10"

OZ-3887-25



CHERON

1:3



gebogen
curved

25 cm – 10"

OZ-3888-25



EMMET



gerade
straight

21 cm – 8¼"

OZ-3889-21



BOZEMANN

1:3



gerade
straight

26 cm – 10¼"

OZ-3890-26



Tupferzangen Cotton Swab Forceps

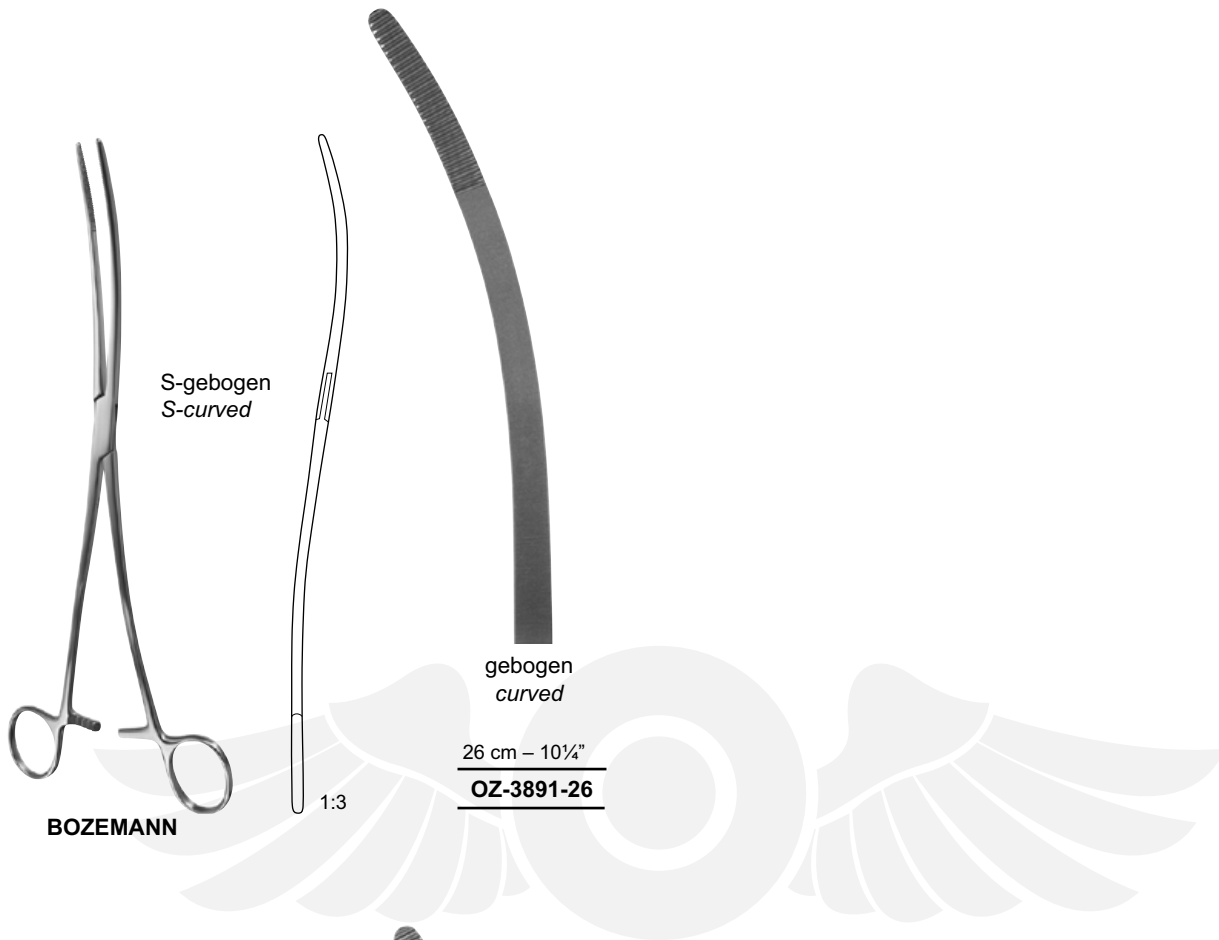

S-gebogen
S-curved

gebogen
curved

26 cm – 10¼"

OZ-3891-26

BOZEMANN

1:3

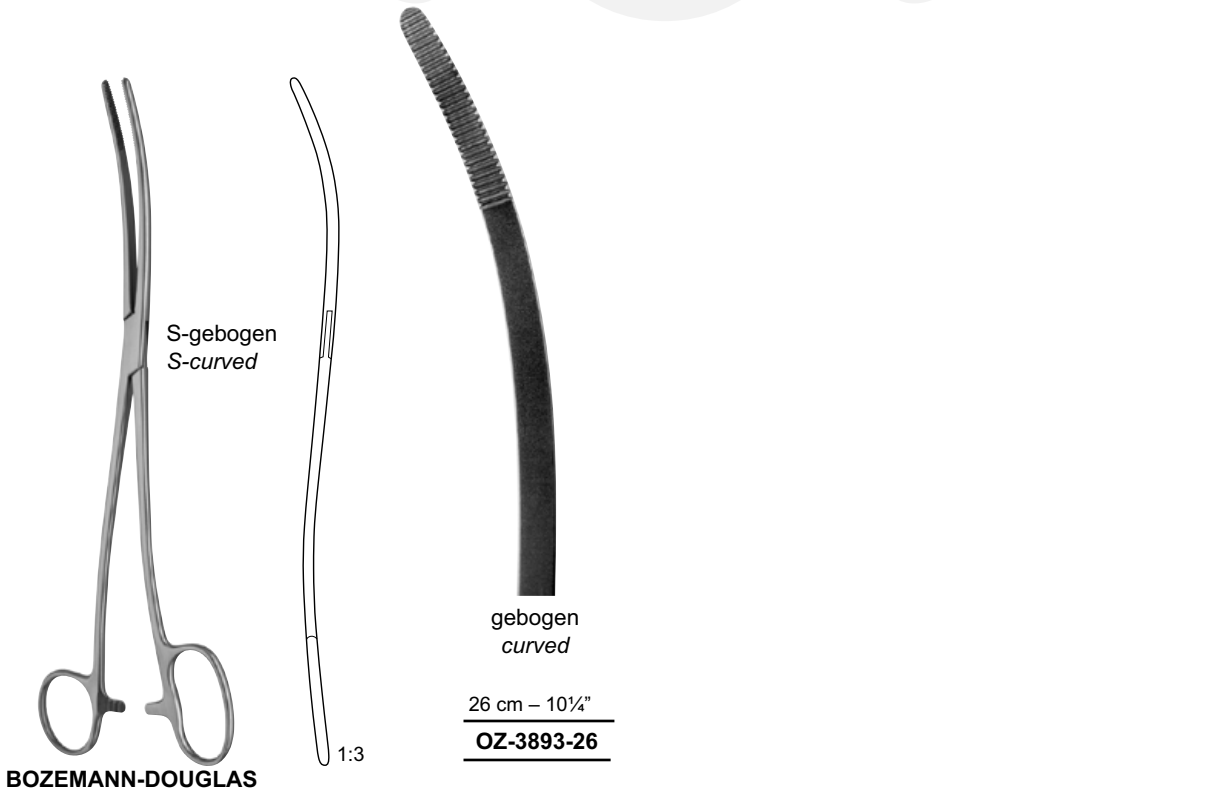

S-gebogen
S-curved

gebogen
curved

26 cm – 10¼"

OZ-3893-26

BOZEMANN-DOUGLAS

1:3



Schwammzangen Sponge Holding Forceps



FÖRSTER-BALLENGER



gerade, glatt
straight, smooth

gebogen, glatt
curved, smooth

18 cm – 7"	OZ-3900-18	OZ-3901-18
25 cm – 10"	OZ-3900-25	OZ-3901-25



FÖRSTER-BALLENGER



gerade, gerieft
straight, serrated

gebogen, gerieft
curved, serrated

18 cm – 7"	OZ-3910-18	OZ-3911-18
25 cm – 10"	OZ-3910-25	OZ-3911-25



OZZE MEDICAL & SURGICAL SUPPLIES
TOOLS TO OPERATE

Schwammzangen Sponge Holding Forceps



RAMPLAY



gerade
straight

18 cm – 7"

OZ-3896-18

25 cm – 10"

OZ-3896-25



COLLIN

Zungenzange
Tongue holding forceps



16 cm – 6¼"

OZ-8450-16



Bulldogklemmen Bulldog Clamps

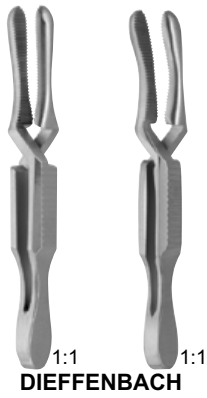

DIEFFENBACH

gerade
straight gebogen
curved

3,5 cm – 1½"	OZ-3144-03	OZ-3145-03
5 cm – 2"	OZ-3144-05	OZ-3145-05



DIEFFENBACH

gerade
straight gebogen
curved

6 cm – 2½"	OZ-3144-06	OZ-3145-06
------------	-------------------	-------------------



JOHNS-HOPKINS

gerade
straight gebogen
curved

3,8 cm – 1½"	OZ-3146-11	OZ-3146-01
4,8 cm – 2"	OZ-3146-12	OZ-3146-02
5,7 cm – 2¼"	OZ-3146-13	OZ-3146-03
6,3 cm – 2½"	OZ-3146-14	OZ-3146-04
7 cm – 2¾"	OZ-3146-15	OZ-3146-05
7,5 cm – 3"	OZ-3146-16	OZ-3146-06
9 cm – 3½"	OZ-3146-17	OZ-3146-07



Bulldogklemmen Bulldog Clamps

Mikro-Clips
Micro clips



gerade
straight

2,7 cm – 1¼"

OZ-3930-01



SCHWARTZ

leicht gebogen
slightly curved

2,7 cm – 1¼"

OZ-3930-02



stark gebogen
strongly curved

2,5 cm – 1"

OZ-3930-03



Anlegezange
für SCHWARTZ Mikro-
Clips *Applying forceps for
SCHWARTZ micro clips*

gebogen
curved

19 cm – 7½"

OZ-3930-80

SCHWARTZ



DE BAKEY-HESS

gewinkelt
angled

4,5 cm – 1¾"

OZ-3936-20

1:1



DE BAKEY-HESS

gewinkelt
angled

5,5 cm – 2¼"

OZ-3936-30

1:1





Bulldogklemmen

Bulldog Clamps

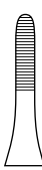

1:1

 10 mm	 14 mm	 18 mm
3 cm – 1¼"	3,5 cm – 1½"	4 cm – 1½"
OZ-3932-00	OZ-3932-04	OZ-3932-08



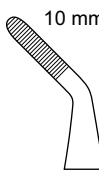
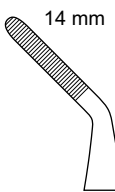
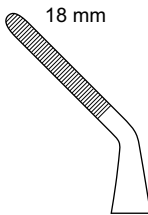

1:1

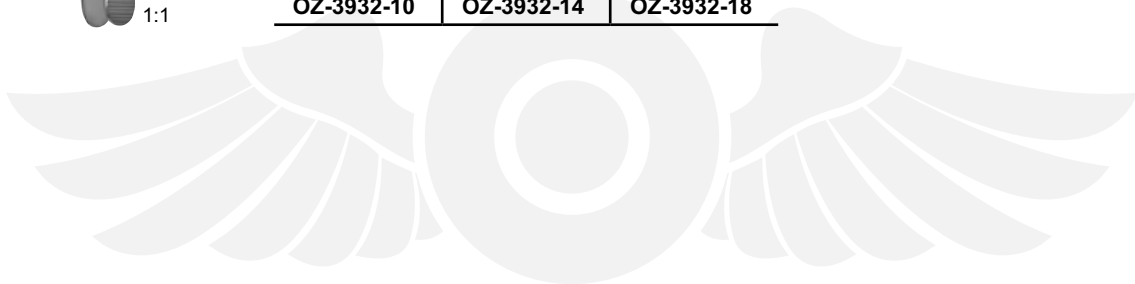
 10 mm	 14 mm	 18 mm
3 cm – 1¼"	3,5 cm – 1½"	4 cm – 1½"
OZ-3932-10	OZ-3932-14	OZ-3932-18

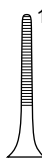
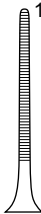

DIETHRICH
1:1

 8 mm	 12 mm	 16 mm
4,9 cm – 2"	5,3 cm – 2"	5,6 cm – 2¼"
OZ-3934-08	OZ-3934-12	OZ-3934-16

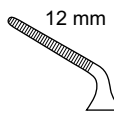
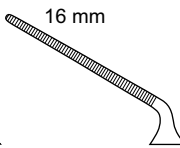
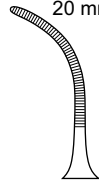
 8 mm	 12 mm	 16 mm	 20 mm
4,3 cm – 1½"	4,5 cm – 1½"	5,6 cm – 2¼"	5,4 cm – 2"
OZ-3935-08	OZ-3935-12	OZ-3935-16	OZ-3935-21



Bulldogklemmen

Bulldog Clamps



DIETHRICH
1:1

DE BAKEY Zahnung
DE BAKEY Serration

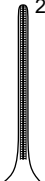
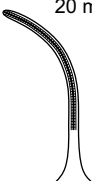
			
10 mm	14 mm	20 mm	20 mm
4,7 cm – 2"	5,1 cm – 2"	5,7 cm – 2¼"	5,4 cm – 2"
OZ-3934-60	OZ-3934-64	OZ-3934-70	OZ-3934-71

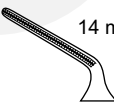
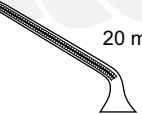
		
10 mm	14 mm	20 mm
4,4 cm – 1½"	4,6 cm – 1½"	4,9 cm – 2"
OZ-3935-60	OZ-3935-64	OZ-3935-70



©ZZE MEDICAL & SURGICAL SUPPLIES

TOOLS TO OPERATE

Australia's Leading Supplier of Medical & Surgical Instruments



©ZZE MEDICAL & SURGICAL SUPPLIES

TOOLS TO OPERATE



FIVE

www.ozzesurgical.com.au

info@ozzesurgical.com.au

Retraktoren Retractors

Feine Wundhäkchen	<i>Fine Wound Retractors</i>	RE 1 - 2
Wund- und Trachealhäkchen	<i>Wound and Trachea Retractors</i>	RE 3 - 6
Wundhaken	<i>Retractors</i>	RE 7 - 29
Spatel	<i>Spatulas</i>	RE 30
Wundspreizer	<i>Self-retaining Retractors</i>	RE 31 - 47, RE 49
Spezialwundspreizer	<i>Special Retractors</i>	RE 48
Bauchdeckenhalter	<i>Abdominal Retractors</i>	RE 50 - 64





Feine Wundhäkchen Fine Wound Retractors

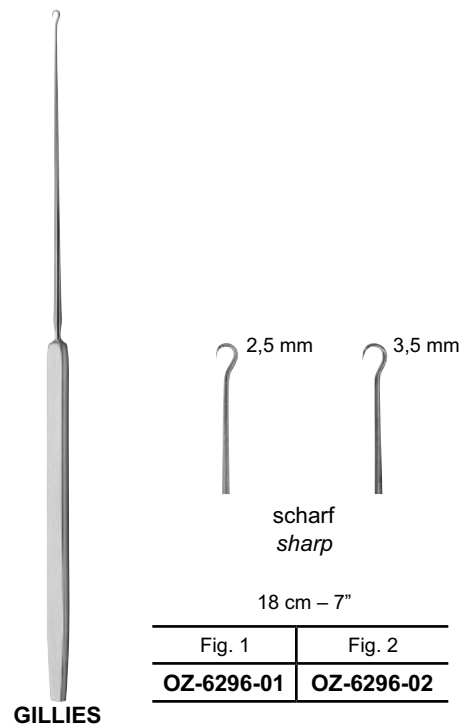
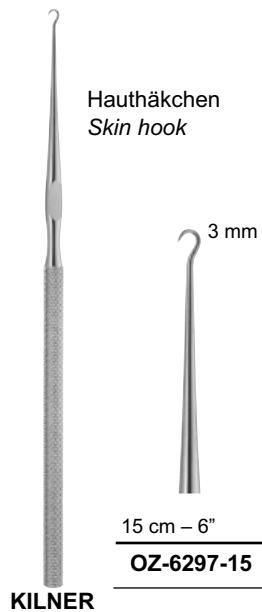
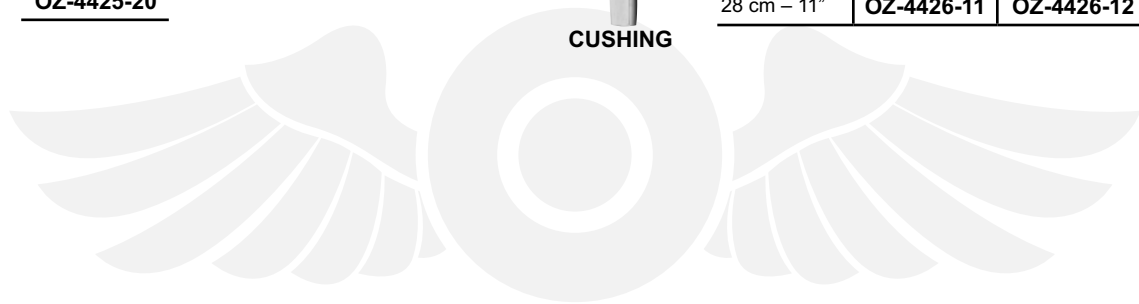
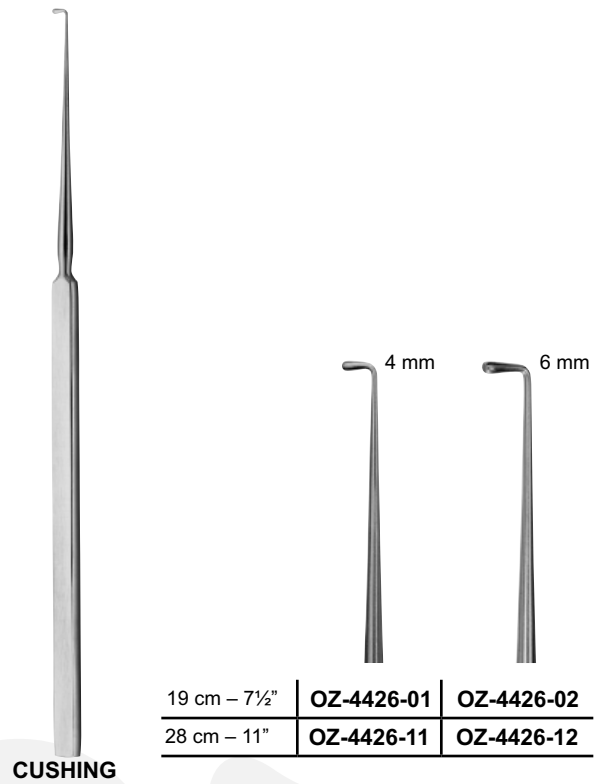
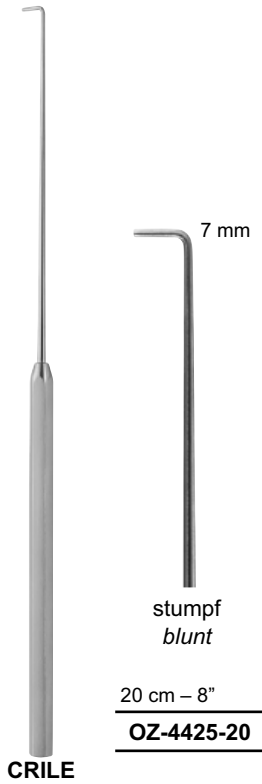



Feine Wundhäkchen Fine Wound Retractors

Hauthäkchen
Skin hook

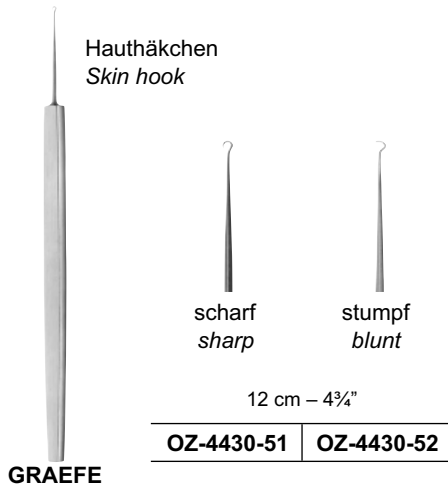

GRAEFE

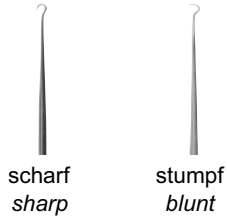

scharf
sharp

stumpf
blunt

12 cm – 4¾"

OZ-4430-51

OZ-4430-52

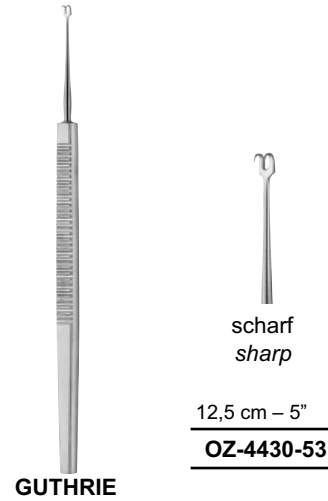

GUTHRIE



scharf
sharp

12,5 cm – 5"

OZ-4430-53

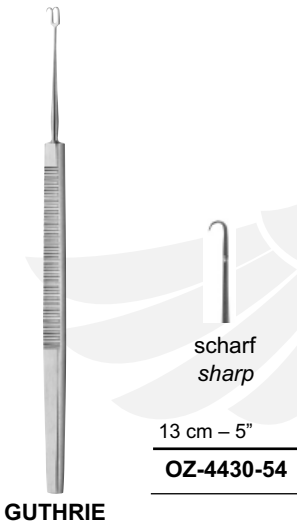

GUTHRIE



scharf
sharp

13 cm – 5"

OZ-4430-54

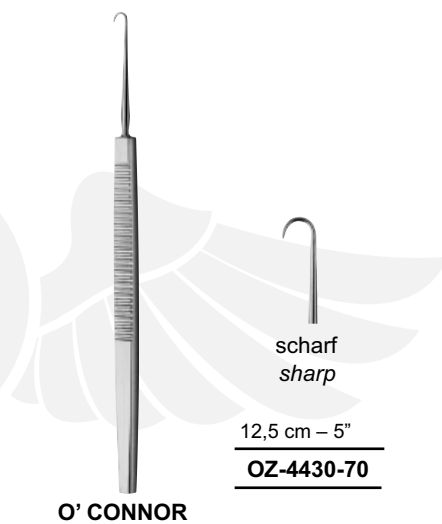

O'CONNOR



scharf
sharp

12,5 cm – 5"

OZ-4430-70

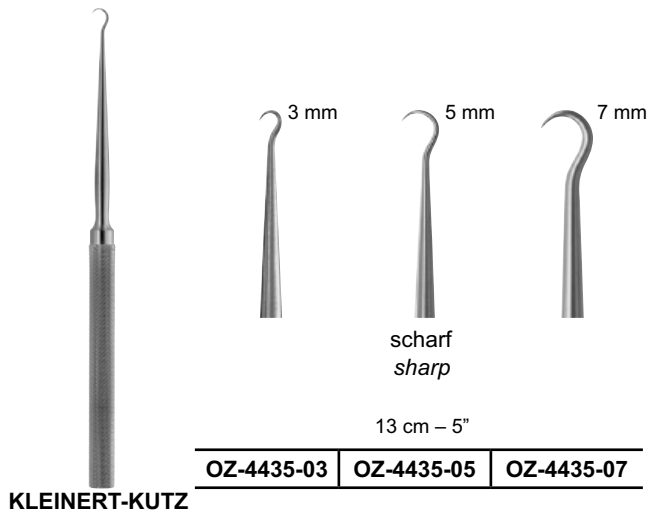

KLEINERT-KUTZ



3 mm



5 mm



7 mm

scharf
sharp

13 cm – 5"

OZ-4435-03

OZ-4435-05

OZ-4435-07

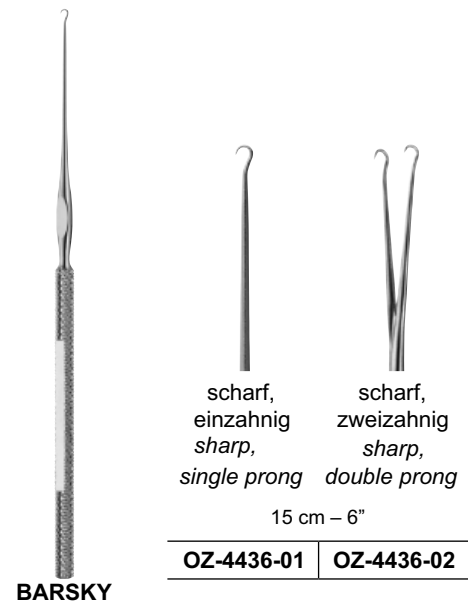

BARSKY



scharf,
einzahnig
sharp,
single prong



scharf,
zweizahnig
sharp,
double prong

15 cm – 6"

OZ-4436-01

OZ-4436-02



Wund- und Trachealhäkchen Wound and Trachea Retractors

MINI-LANGENBECK

10 x 6 mm	17 x 5 mm
16,5 cm – 6½"	
OZ-4430-10	OZ-4430-17

20 x 6 mm	22 x 8 mm
16,5 cm – 6½"	
OZ-4430-20	OZ-4430-22

JACKSON

17 cm – 6¾"
OZ-4439-17

NEWS

Trachealhäkchen
Trachea hook

15 cm – 6"
OZ-4440-15

CLOWARD

75 mm	16 cm – 6¼"
75 x 18 mm	OZ-4454-18
75 x 20 mm	OZ-4454-20
75 x 23 mm	OZ-4454-23



Wund- und Trachealhäkchen

Wound and Trachea Retractors

Standard
Standard



scharf
sharp

16,5 cm – 6½"

OZ-4460-01	OZ-4460-02	OZ-4460-03	OZ-4460-04
------------	------------	------------	------------



stumpf
blunt

16,5 cm – 6½"

OZ-4461-01	OZ-4461-02	OZ-4461-03	OZ-4461-04
------------	------------	------------	------------

fein
delicate



scharf
sharp

16 cm – 6¼"

OZ-4462-01	OZ-4462-02	OZ-4462-03	OZ-4462-04
------------	------------	------------	------------



stumpf
blunt

16 cm – 6¼"

OZ-4463-01	OZ-4463-02	OZ-4463-03	OZ-4463-04
------------	------------	------------	------------

Wund- und Trachealhäkchen Wound and Trachea Retractors



scharf
sharp

15,5 cm – 6"

OZ-4464-01	OZ-4464-02	OZ-4464-03	OZ-4464-04
-------------------	-------------------	-------------------	-------------------

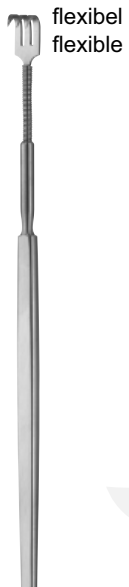

stumpf
blunt

15,5 cm – 6"

OZ-4465-01	OZ-4465-02	OZ-4465-03	OZ-4465-04
-------------------	-------------------	-------------------	-------------------



16 cm – 6¼"

OZ-4466-01	OZ-4466-02
-------------------	-------------------



13 cm – 5"

OZ-4468-13



14 cm – 5½"

OZ-4469-14



Wund- und Trachealhäkchen Wound and Trachea Retractors



ITERSON

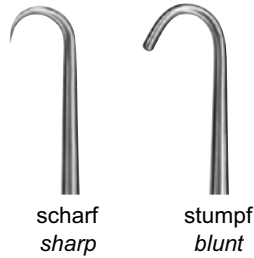

scharf
sharp

stumpf
blunt

16 cm – 6¼"

Fig. 1	Fig. 2
OZ-4471-01	OZ-4471-02



scharf
sharp

11,5 cm – 4½"

OZ-4472-02	OZ-4472-03	OZ-4472-04	OZ-4472-06
-------------------	-------------------	-------------------	-------------------



VOLKMANN



stumpf
blunt

11,5 cm – 4½"

OZ-4473-02	OZ-4473-03	OZ-4473-04	OZ-4473-06
-------------------	-------------------	-------------------	-------------------



OZZE MEDICAL & SURGICAL SUPPLIES
TOOLS TO OPERATE

Wundhaken Retractors



LITTLE

12 x 14 mm



20 cm – 8"

OZ-4455-20



LOVE (MORSE)

1:3



25 cm – 10"

10 mm	OZ-4456-10
15 mm	OZ-4456-15
20 mm	OZ-4456-20
30 mm	OZ-4456-30
40 mm	OZ-4456-40
50 mm	OZ-4456-50



CUSHING

1:3



25 cm – 10"

11 x 14 mm	OZ-4456-81
13 x 18 mm	OZ-4456-82
15 x 22 mm	OZ-4456-83



CUSHING



Breite
Width

20 cm – 8"

8 mm	OZ-4474-08
10 mm	OZ-4474-10
12 mm	OZ-4474-12
14 mm	OZ-4474-14
16 mm	OZ-4474-16
18 mm	OZ-4474-18



Wundhaken Retractors



CUSHING

Breite Width	24 cm – 9½"
8 mm	OZ-4474-58
10 mm	OZ-4474-60
12 mm	OZ-4474-62
14 mm	OZ-4474-64
16 mm	OZ-4474-66
18 mm	OZ-4474-68



1:3



DESMARRES

Breite Width	14 cm – 5½"
8 mm	OZ-4475-08
10 mm	OZ-4475-10
11 mm	OZ-4475-11
12 mm	OZ-4475-12
13 mm	OZ-4475-13
14 mm	OZ-4475-14
15 mm	OZ-4475-15
16 mm	OZ-4475-16
18 mm	OZ-4475-18



CRILE

12 x 4 mm
20 x 6 mm
11 cm – 4¼"
OZ-4478-11



LUER

11 cm – 4¼"
OZ-4479-11



OZZE MEDICAL & SURGICAL SUPPLIES
TOOLS TO OPERATE

Wundhaken Retractors



	17 cm – 6¾"
6 x 25 mm	OZ-4481-01
8 x 25 mm	OZ-4481-02

LANGENBECK-GREEN



Dekompressionshaken
Decompression hook



20 cm – 8"
OZ-4485-20

CUSHING



7 x 8 mm



18 x 6 mm

SENN-MUELLER

scharf <i>sharp</i>	stumpf <i>blunt</i>
16 cm – 6¼"	
OZ-4486-01	OZ-4486-02



Wundhaken Retractors

7 x 8 mm

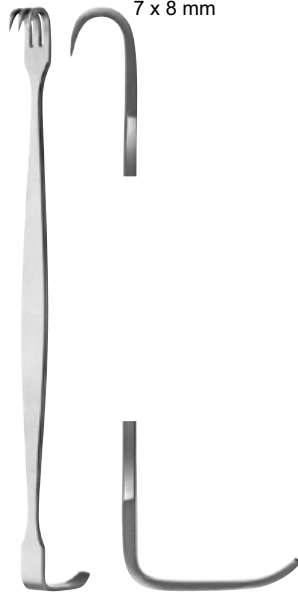

BABY-SENN-MUELLER

22 x 7 mm

scharf <i>sharp</i>	stumpf <i>blunt</i>
15,5 cm – 6"	
OZ-4487-01	OZ-4487-02

7 x 3,5 mm

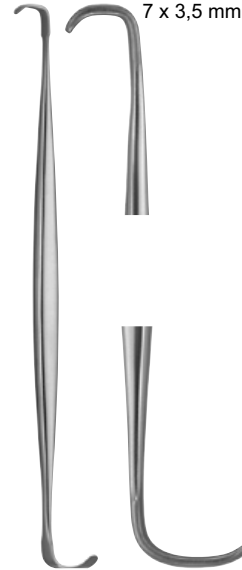

RAGNELL-DAVIS

14 x 5 mm

15 cm – 6"
OZ-4488-14



SENN-GREEN

10 x 6 mm



20 x 6 mm



16 cm – 6 1/4"

OZ-4489-01	OZ-4489-02
-------------------	-------------------



LANGENBECK-GREEN



scharf
sharp

16 cm – 6 1/4"

OZ-4490-01	OZ-4490-02	OZ-4490-03
-------------------	-------------------	-------------------

11 x 13 mm



16 x 6 mm



25 x 6 mm



16 cm – 6 1/4"

OZ-4490-13	OZ-4490-16	OZ-4490-25
-------------------	-------------------	-------------------



Wundhaken Retractors



ROUX

OZ-4492-00

Satz bestehend aus:
OZ-4492-01, OZ-4492-02, OZ-4492-03
Set consisting of:
OZ-4492-01, OZ-4492-02, OZ-4492-03

14 cm – 5½"	Fig. 1	OZ-4492-01
15 cm – 6"	Fig. 2	OZ-4492-02
17 cm – 6¾"	Fig. 3	OZ-4492-03



BABY-ROUX

17 x 16 mm
18 x 22 mm
13 cm – 5"
OZ-4492-13

30 x 31 mm



GOELET

37 x 40 mm

19 cm – 7½"
OZ-4493-19

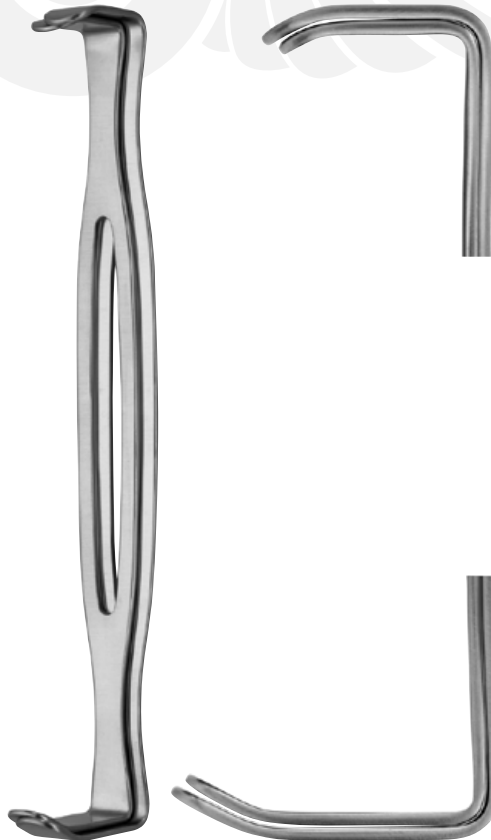

PARKER-LANGENBECK

Satz
Set
21 cm – 8¼"
OZ-4494-21



Wundhaken Retractors



Satz
Set
13,5 cm – 5¼"
OZ-4495-13

PARKER



Satz
Set
18 cm – 7"
OZ-4495-18

PARKER



Satz
Set
16 cm – 6¼"
OZ-4496-00

PARKER-MOTT

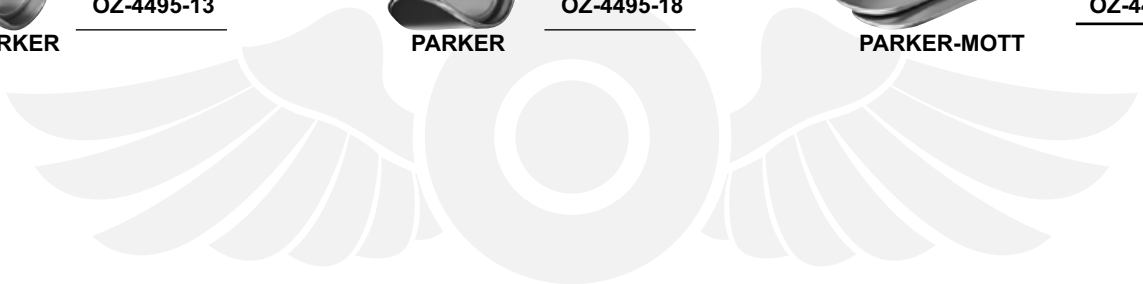

Satz
Set
12 cm – 4¾"
OZ-4497-12

FARABEUF



Satz
Set
15 cm – 6"
OZ-4497-15

FARABEUF



OZZE MEDICAL & SURGICAL SUPPLIES
TOOLS TO OPERATE

Wundhaken Retractors



COLLIN

Satz
Set

16,5 cm – 6½"

OZ-4498-00



MATHIEU

Satz
Set

19 cm – 7½"

OZ-4499-00



OLLIER



22,5 cm – 8¾"

OZ-4510-03

OZ-4510-04

Wundhaken Retractors

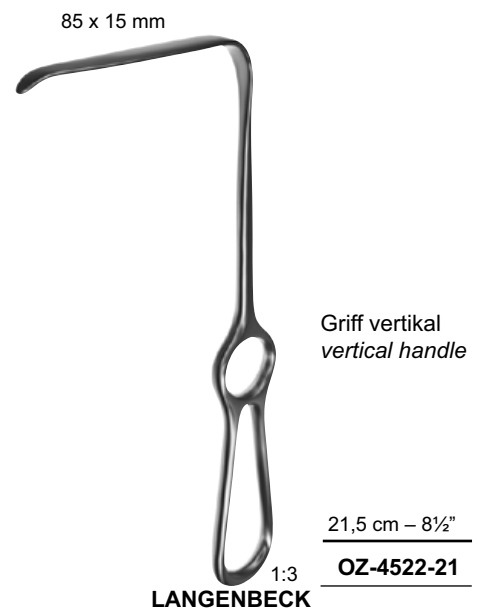
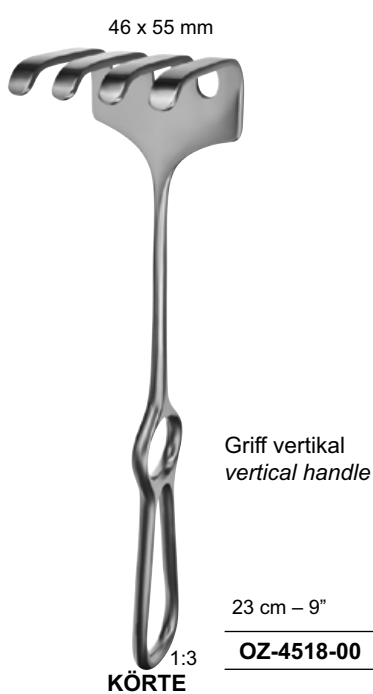
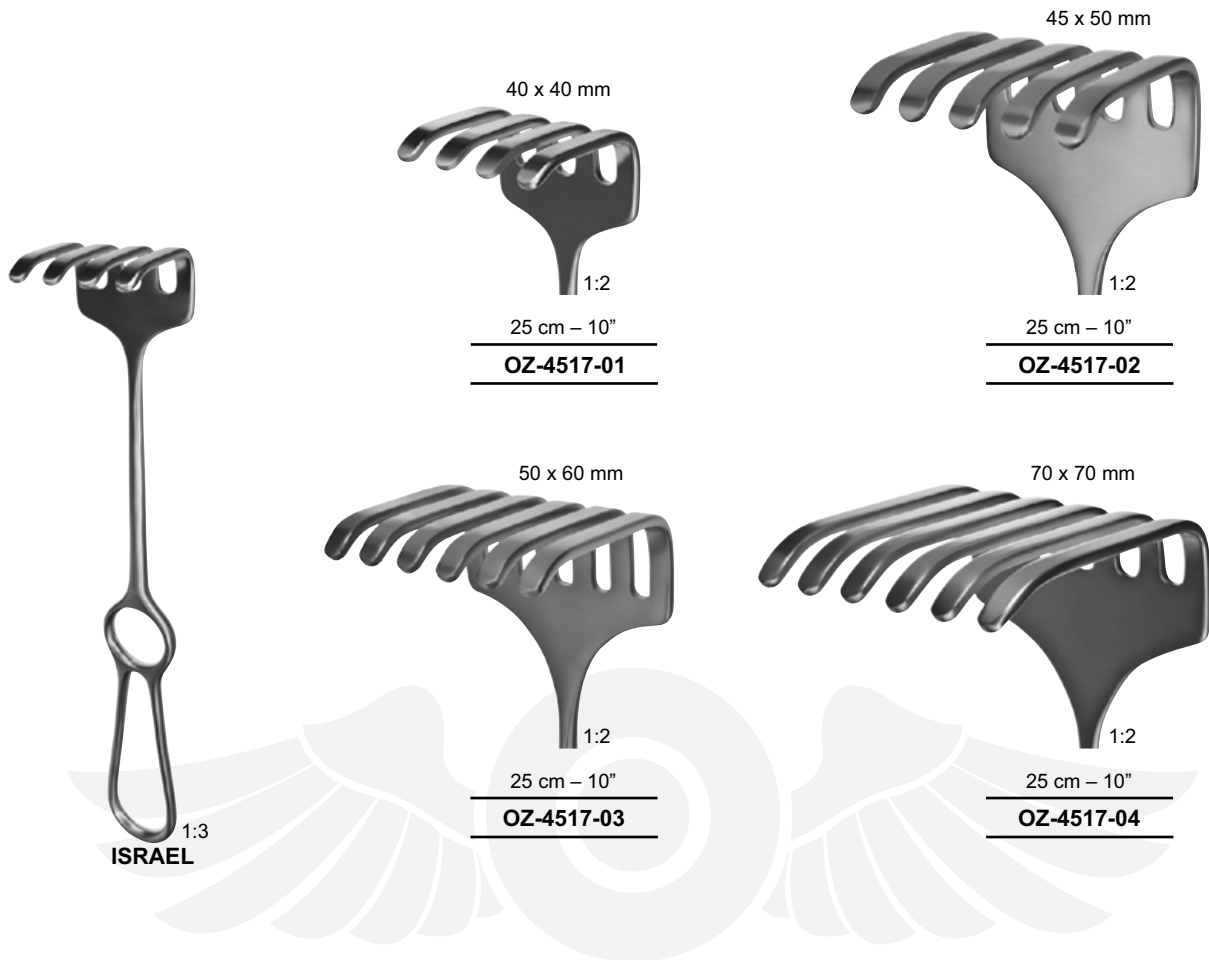



Wundhaken Retractors



LANGENBECK

	21 cm – 8¼"
55 x 20 mm	OZ-4522-01
63 x 20 mm	OZ-4522-02
60 x 20 mm	OZ-4522-05



LANGENBECK



	23 cm – 9"
35 x 7 mm	OZ-4523-01
35 x 10 mm	OZ-4523-02
35 x 15 mm	OZ-4523-03
60 x 20 mm	OZ-4523-04

28 x 6 mm



LAHEY

	19 cm – 7½"
	OZ-4525-19



SAUERBRUCH



	22,5 cm – 8¾"
45 x 15 mm	OZ-4526-01
55 x 23 mm	OZ-4526-02
72 x 20 mm	OZ-4526-03



Wundhaken Retractors



LANGENBECK

38 x 20 mm



21 cm – 8¼"

30 x 11 mm	OZ-4530-01
30 x 14 mm	OZ-4530-02
33 x 14 mm	OZ-4530-03
30 x 16 mm	OZ-4530-04
40 x 11 mm	OZ-4530-05
42 x 13 mm	OZ-4530-06
50 x 11 mm	OZ-4530-07



LANGENBECK

Hohlheftgriff
Hollow handle

22 cm – 8¾"

30 x 11 mm	OZ-4531-01
40 x 11 mm	OZ-4531-05
42 x 13 mm	OZ-4531-06



KOCHER

22 cm – 8¾"

OZ-4535-01



KOCHER



19 cm – 7½"

19 x 12 mm	OZ-4536-01
21 x 12 mm	OZ-4536-02



Wundhaken Retractors



KOCHER-LANGENBECK

	21,5 cm – 8½"
25 x 6 mm	OZ-4538-11
25 x 8 mm	OZ-4538-12
35 x 8 mm	OZ-4538-13
35 x 11 mm	OZ-4538-14
35 x 15 mm	OZ-4538-15
40 x 11 mm	OZ-4538-16
55 x 11 mm	OZ-4538-17
70 x 14 mm	OZ-4538-18
80 x 12 mm	OZ-4538-19
80 x 16 mm	OZ-4538-20



CASPAR

67 x 17 mm
21,5 cm – 8½"
OZ-4537-21



KOCHER

	23 cm – 9"
40 x 18 mm	OZ-4539-11
60 x 20 mm	OZ-4539-12
60 x 25 mm	OZ-4539-13
75 x 30 mm	OZ-4539-14
75 x 40 mm	OZ-4539-15



KOCHER-WAGNER

	28 cm – 11"
22 x 15 mm	OZ-4540-01
38 x 20 mm	OZ-4540-02
67 x 25 mm	OZ-4540-03
100 x 35 mm	OZ-4540-04



Wundhaken Retractors



ST. MARKS

160 x 60 mm	29 cm – 11 ½"
OZ-4543-00/29	



ST. MARKS

180 x 60 mm	32,5 cm – 12 ¾"
OZ-4543-00/32	



ST. MARKS

180 x 60 mm	33 cm – 13"
OZ-4543-00/33	



Wundhaken Retractors



1:3
HÖSEL

	25 cm – 10"
60 x 20 mm	OZ-4542-01
80 x 30 mm	OZ-4542-02
100 x 30 mm	OZ-4542-03
120 x 30 mm	OZ-4542-04
140 x 30 mm	OZ-4542-05
140 x 40 mm	OZ-4542-06

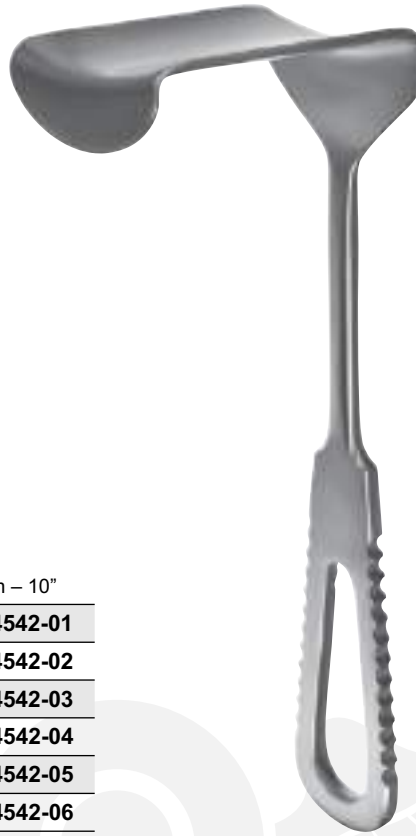

MORRIS

	21 cm – 8¼"
70 x 40 mm	OZ-4544-40
70 x 50 mm	OZ-4544-50
70 x 65 mm	OZ-4544-65



CANNY-RYALL

19 cm – 7½"	16 mm	OZ-4544-47
19 cm – 7½"	20 mm	OZ-4544-48
20 cm – 8"	25 mm	OZ-4544-49



1:3
MORRIS

	24 cm – 9½"
32 x 50 mm / 38 x 50 mm	OZ-4544-01
45 x 50 mm / 50 x 50 mm	OZ-4544-02
65 x 50 mm / 38 x 50 mm	OZ-4544-03



Wundhaken Retractors



WYLIE

1:3

30,5 cm – 12"	75 x 23 mm	OZ-4548-30
33 cm – 13"	175 x 23 mm	OZ-4548-33



GREEN

22 cm – 8¾"	OZ-4549-22
-------------	-------------------



MIDDELDORPF

21,5 cm – 8½"	14 x 17 mm	OZ-4551-01
22 cm – 8¾"	20 x 22 mm	OZ-4551-02
23,5 cm – 9¼"	26 x 30 mm	OZ-4551-03



MIDDELDORPF

1:3

	25,5 cm – 10"
45 x 45 mm	OZ-4551-51
45 x 50 mm	OZ-4551-52
55 x 70 mm	OZ-4551-53



1:3

RICHARDSON

	24 cm – 9½"
28 x 20 mm	OZ-4552-11
30 x 28 mm	OZ-4552-12
38 x 37 mm	OZ-4552-13
52 x 22 mm	OZ-4552-14



1:3

RICHARDSON-EASTMAN

OZ-4553-00

Satz bestehend aus:
 OZ-4553-01, OZ-4553-02

Set consisting of:
 OZ-4553-01, OZ-4553-02

25 cm – 10"	24 x 22 mm / 30 x 30 mm	Fig. 1	OZ-4553-01
27 cm – 10½"	40 x 37 mm / 65 x 43 mm	Fig. 2	OZ-4553-02

51 x 19 mm



1:3

RICHARDSON

	23,5 cm – 9¼"
	OZ-4552-55



1:3

RICHARDSON

	24 cm – 9½"
64 x 41 mm	OZ-4552-51
25 x 19 mm	OZ-4552-52
32 x 25 mm	OZ-4552-53
38 x 38 mm	OZ-4552-54



Wundhaken Retractors



KELLY 1:3

	26 cm – 10¼"
40 x 50 mm	OZ-4554-00
50 x 65 mm	OZ-4554-01
65 x 75 mm	OZ-4554-02
75 x 90 mm	OZ-4554-03



KELLY 1:3

	25 cm – 10"
51 x 38 mm	OZ-4554-50
64 x 51 mm	OZ-4554-51
76 x 64 mm	OZ-4554-52
89 x 76 mm	OZ-4554-53



FRITSCH 1:3

	24 cm – 9½"
45 x 40 mm	OZ-4555-01
45 x 50 mm	OZ-4555-02
45 x 60 mm	OZ-4555-03
45 x 75 mm	OZ-4555-04
65 x 85 mm	OZ-4555-05



DOYEN 1:3

50 x 85 mm	25 cm – 10"
	OZ-4556-25



Wundhaken Retractors



1:3
DOYEN-STILLE

	24 cm – 9½"
15 x 90 mm	OZ-4557-01
20 x 90 mm	OZ-4557-02
30 x 90 mm	OZ-4557-03
35 x 110 mm	OZ-4557-04
40 x 110 mm	OZ-4557-05
55 x 120 mm	OZ-4557-06

70 x 25 mm



1:3
KOCHER

	22,5 cm – 8¾"
	OZ-4557-22



1:3
KOCHER

	25 cm – 10"
80 x 42 mm	OZ-4558-01
80 x 50 mm	OZ-4558-02
80 x 60 mm	OZ-4558-03



1:3
SIMON

	28 cm – 11"
115 x 22 mm	OZ-4560-01
115 x 27 mm	OZ-4560-02



Wundhaken Retractors

105 x 27 mm



1:3
MARTÍN

26 cm – 10¼"
OZ-4562-26



1:3
BRUNNER

	25 cm – 10"
80 x 20 mm	OZ-4563-08
100 x 25 mm	OZ-4563-10
120 x 25 mm	OZ-4563-12
130 x 30 mm	OZ-4563-13
140 x 30 mm	OZ-4563-14
160 x 30 mm	OZ-4563-16
180 x 30 mm	OZ-4563-18



19 mm



DEAVER

18 cm – 7"
OZ-4570-01

22 mm



DEAVER

21,5 cm – 8½"
OZ-4570-02



Wundhaken Retractors

25 mm

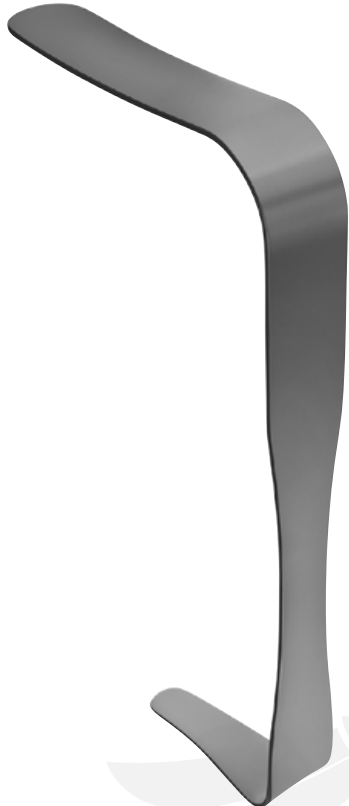

DEAVER

23 cm – 9"
OZ-4570-03

25 mm



DEAVER

30 cm – 11¾"	OZ-4570-04
33 cm – 13"	OZ-4570-05
36 cm – 14¼"	OZ-4570-06



DEAVER

	30 cm – 11¾"
38 mm	OZ-4570-07
50 mm	OZ-4570-08
75 mm	OZ-4570-09



DEAVER

Hohlgriff
Hollow handle

	30 cm – 11¾"
25 mm	OZ-4571-04
38 mm	OZ-4571-07
50 mm	OZ-4571-08
75 mm	OZ-4571-09



Wundhaken Retractors



1:3
HARRINGTON

	32 cm – 12½"
40 x 127 mm	OZ-4572-01
62 x 127 mm	OZ-4572-02



MEYERDING

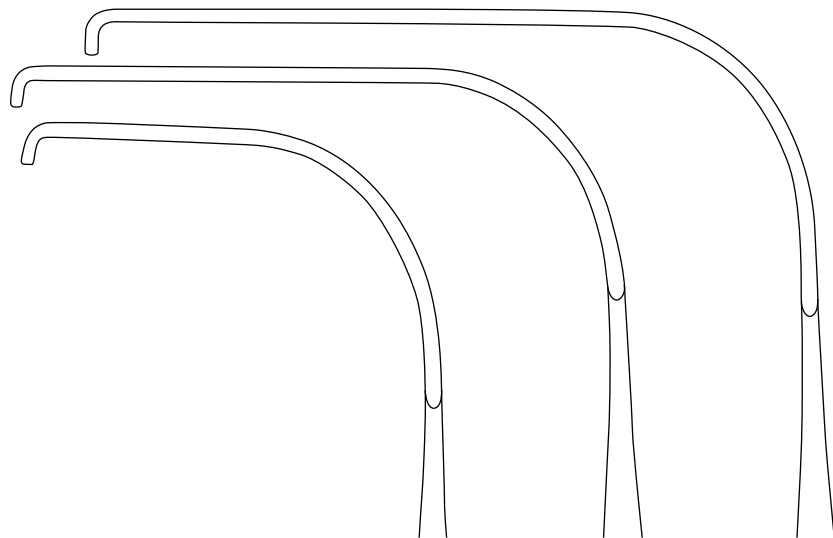

52 x 16 mm	76 x 25 mm	89 x 50 mm
23 cm – 9"	23 cm – 9"	25,5 cm – 10"
OZ-4573-01	OZ-4573-02	OZ-4573-03

Wundhaken Retractors



HIBBS

OZ-4575-00

Satz bestehend aus:
OZ-4575-01, OZ-4575-02

Set consisting of:
OZ-4575-01, OZ-4575-02



Fig. 1

75 x 25 mm

24,5 cm – 9¾"

OZ-4575-01

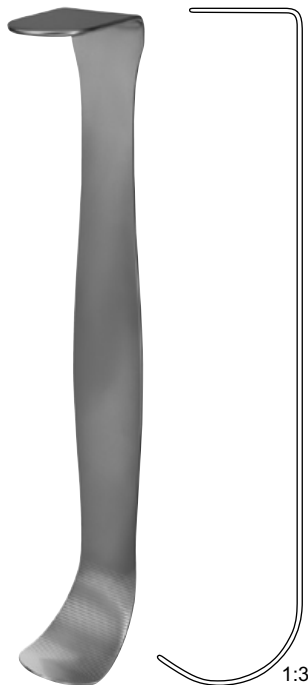

Fig. 2

80 x 25 mm

24,5 cm – 9¾"

OZ-4575-02



HEANEY

	27 cm – 10½"
45 x 25 mm	OZ-4575-51
73 x 28 mm	OZ-4575-52
82 x 28 mm	OZ-4575-53



LERICHE

45 mm

25,5 cm – 10"

OZ-4579-01

60 mm

27,5 cm – 10¾"

OZ-4579-02



Wundhaken Retractors



1:3
BRUNNER

	25,5 cm – 10"
80 x 20 mm	OZ-4564-01
100 x 20 mm	OZ-4564-02
120 x 25 mm	OZ-4564-03
140 x 25 mm	OZ-4564-04



1:3
MIKULICZ

	26 cm – 10¼"
85 x 35 mm	OZ-4565-01
120 x 50 mm	OZ-4565-02
155 x 50 mm	OZ-4565-03



1:3
MIKULICZ

90 x 50 mm

	26 cm – 10¼"
	OZ-4566-26



1:3
KELLY

	27 cm – 10½"
160 x 38 mm	OZ-4567-01
160 x 57 mm	OZ-4567-02
190 x 38 mm	OZ-4567-51
190 x 57 mm	OZ-4567-52



Wundhaken Retractors

	16 cm – 6¼"
75 x 50 mm	OZ-4590-01
75 x 90 mm	OZ-4590-02



DAVIDSON

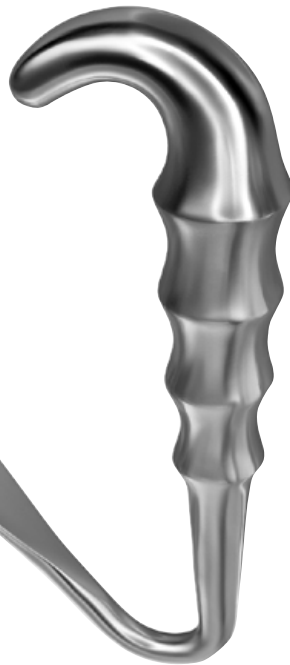

ROSS

		27 cm – 10½"
Fig. 1	15 x 16 mm	OZ-4593-01
Fig. 2	13 x 23 mm	OZ-4593-02
Fig. 3	17 x 23 mm	OZ-4593-03
Fig. 4	13 x 27 mm	OZ-4593-04
Fig. 5	29 x 29 mm	OZ-4593-05
Fig. 6	40 x 21 mm	OZ-4593-06



COOLEY



35 x 45 mm
21,5 cm – 8½"
OZ-4591-01

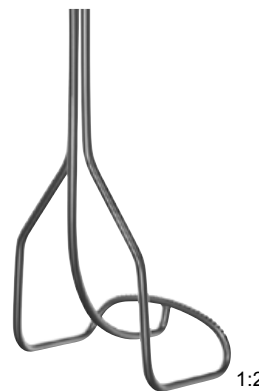

45 x 50 mm
21,5 cm – 8½"
OZ-4591-02

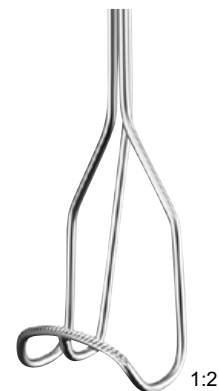

20 x 50 mm
26 cm – 10¼"
OZ-4591-03



Spatel Spatulas



biegsam
malleable

	33 cm – 13"
20 mm	OZ-4580-20
25 mm	OZ-4580-25
30 mm	OZ-4580-30
35 mm	OZ-4580-35
40 mm	OZ-4580-40
45 mm	OZ-4580-45
50 mm	OZ-4580-50
64 mm	OZ-4580-64
76 mm	OZ-4580-76
1:3 102 mm	OZ-4580-99



biegsam
malleable

17 / 25 mm
20 cm – 8"
OZ-4582-20

TUFFIER



biegsam
malleable

20 cm – 8"	6 mm	OZ-4584-06
	8 mm	OZ-4584-08
	10 mm	OZ-4584-10
	12 mm	OZ-4584-12
	17 mm	OZ-4584-17
	20 mm	OZ-4584-20
25 cm – 10"	25 mm	OZ-4584-25
	25 mm	OZ-4584-29



biegsam
malleable

28 cm – 11"	25 / 30 mm	OZ-4585-01
30 cm – 11¾"	37 / 45 mm	OZ-4585-02
	40 / 50 mm	OZ-4585-03

HABERER



28,5 cm – 11¼"

OZ-4587-28

REVERDIN

Wundspreizer Self-retaining Retractors



2 : 3 Zähne
2 : 3 teeth

	scharfsharp	stumpfb blunt
5 cm – 2"	OZ-4640-05	OZ-4641-05

FINSEN



3 : 4 Zähne
3 : 4 teeth

	scharfsharp	stumpfb blunt
7 cm – 2¾"	OZ-4640-07	OZ-4641-07

FINSEN



3 : 4 Zähne
3 : 4 teeth

scharf
sharp

7 cm – 2¾"

OZ-4642-07

FINSEN

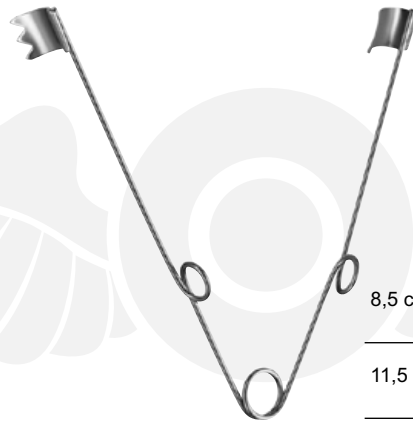

8,5 cm – 3¼"

Spreizweite: 60 mm
Spread: 60 mm

OZ-4643-08

11,5 cm – 4½"

Spreizweite: 60 mm
Spread: 60 mm

OZ-4643-11



ALM

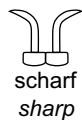

7 cm – 2¾"	OZ-4650-07	OZ-4651-07
10 cm – 4"	–	OZ-4651-10



HEISS



10 cm – 4"	
OZ-4655-00	OZ-4655-10



Wundspreizer Self-retaining Retractors

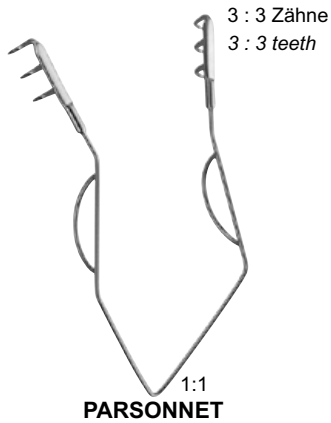

Größe Size	Epicardial Wundspreizer Epicardial retractors	
25 mm	Spreizweite: 15 mm Spread: 15 mm	OZ-4660-01
33 mm	Spreizweite: 19 mm Spread: 19 mm	OZ-4660-02
38 mm	Spreizweite: 24 mm Spread: 24 mm	OZ-4660-03
52 mm	Spreizweite: 32 mm Spread: 32 mm	OZ-4660-04

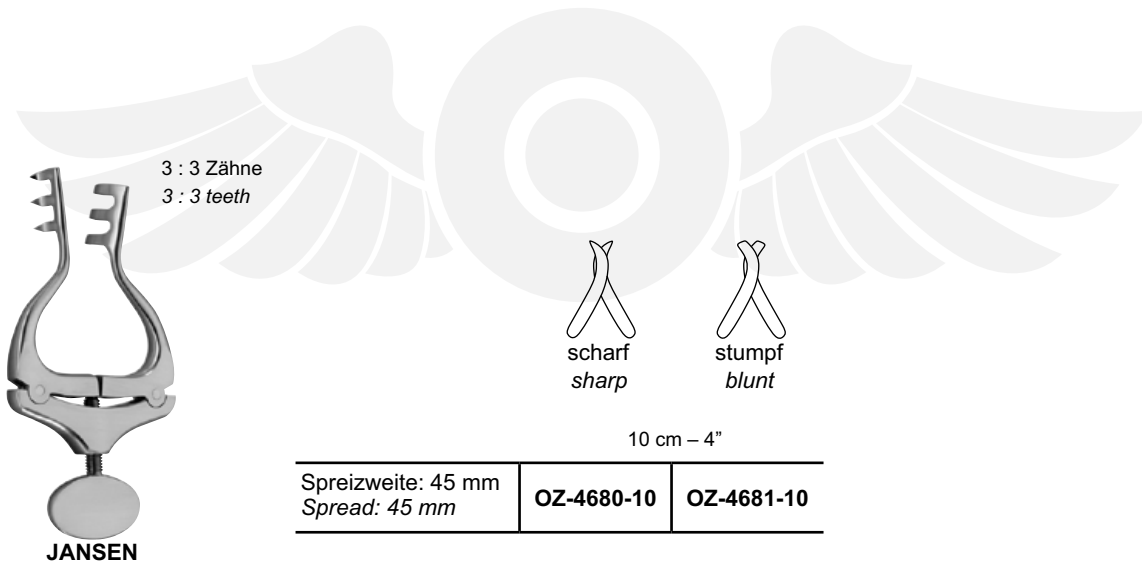

Spreizweite: 45 mm Spread: 45 mm	OZ-4680-10	OZ-4681-10
-------------------------------------	-------------------	-------------------



Wundspreizer Self-retaining Retractors

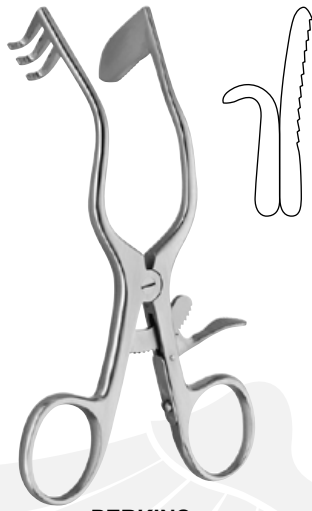

PERKINS

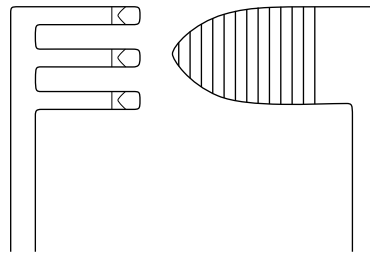

volles Blatt rechts,
scharf gezahnt
*solid blade right,
sharp serrated*

13 cm – 5"

OZ-4688-01

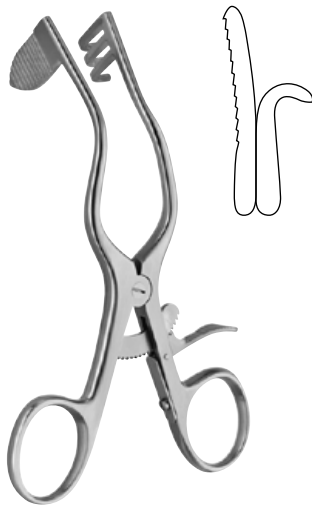

PERKINS

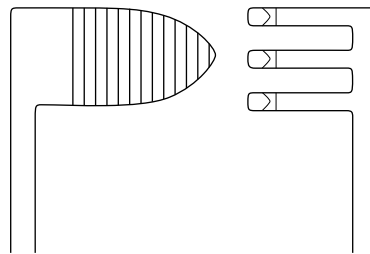

volles Blatt links,
scharf gezahnt
*solid blade left,
sharp serrated*

13 cm – 5"

OZ-4688-02



Wundspreizer Self-retaining Retractors

Spreizweite: 55 mm
Spread: 55 mm

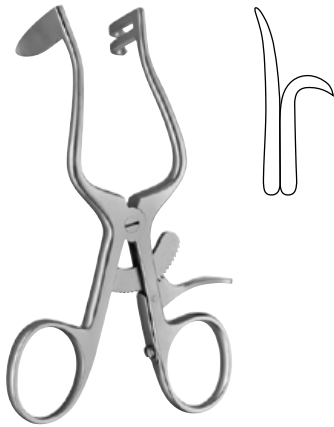

PLESTER

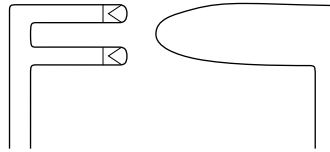

Blatt links voll
Blatt rechts 2 Zähne, scharf
Blade left solid, sharp
Blade left 2 teeth, sharp

11 cm – 4 1/4"

OZ-4690-01

Spreizweite: 55 mm
Spread: 55 mm



PLESTER

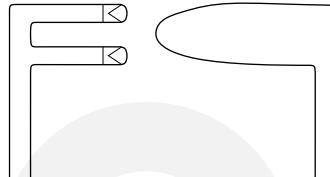

Blatt rechts voll
Blatt links 2 Zähne, scharf

Blade right solid, sharp
Blade left 2 teeth, sharp

11 cm – 4 1/4"

OZ-4690-02



PLESTER

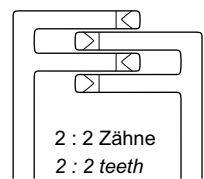

scharf stumpf
sharp blunt

13 cm – 5"

OZ-4691-01 | **OZ-4691-02**

Spreizweite: 60 mm
Spread: 60 mm



Wundspreizer Self-retaining Retractors



FISH

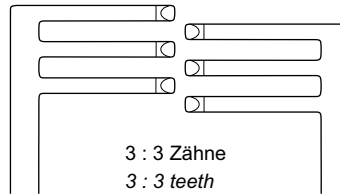

stumpf
blunt

17 cm – 6¾"

OZ-4694-11



WEITLANER

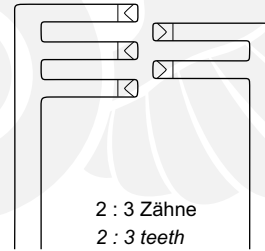

scharf
sharp

stumpf
blunt

halbscharf
semi-sharp

10,5 cm – 4¼"

OZ-4700-10

OZ-4701-10

OZ-4702-10



WEITLANER

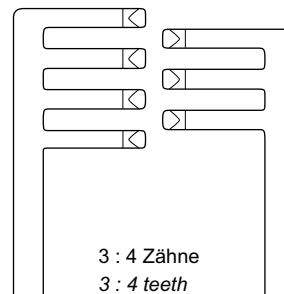

scharf
sharp

stumpf
blunt

halbscharf
semi-sharp

13 cm – 5"

OZ-4700-13

OZ-4701-13

OZ-4702-13

16,5 cm – 6½"

OZ-4700-16

OZ-4701-16

OZ-4702-16



Wundspreizer Self-retaining Retractors



JEFFERSEN

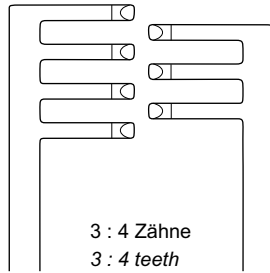

3 : 4 Zähne
3 : 4 teeth

stumpf
blunt

14 cm – 5½"

OZ-4709-10



MOLLISON

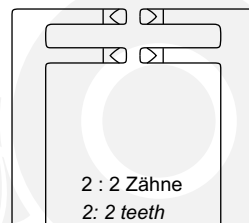
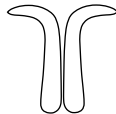

2 : 2 Zähne
2 : 2 teeth

scharf
sharp

14 cm – 5½"

OZ-4709-20



WEITLANER-WULLSTEIN

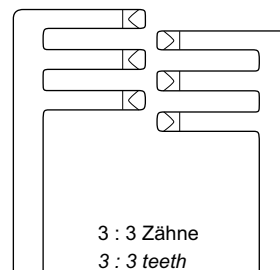

3 : 3 Zähne
3 : 3 teeth

scharf
sharp

stumpf
blunt

13 cm – 5"

Spreizweite: 45 mm
Spread: 45 mm

OZ-4710-13

OZ-4711-13

16,5 cm – 6½"

Spreizweite: 75 mm
Spread: 75 mm

OZ-4710-16

OZ-4711-16



Wundspreizer Self-retaining Retractors



MOLLISON

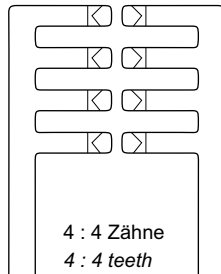

4 : 4 Zähne
4 : 4 teeth

scharf
sharp

15 cm – 6"

OZ-4714-15



CLOWARD

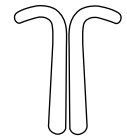

stumpf
blunt

14 cm – 5½"

OZ-4715-14



**TÜBINGER MODELL
TUEBINGEN PATTERN**

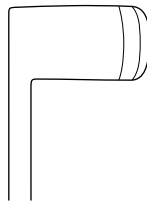

stumpf
blunt

16 cm – 6¼"

OZ-4716-16



Wundspreizer Self-retaining Retractors



MAYO-ADAMS

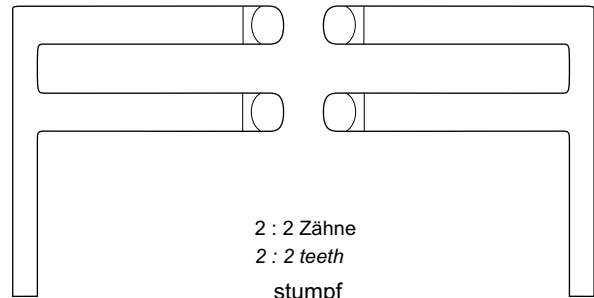
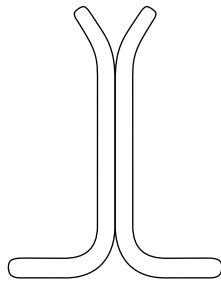

2 : 2 Zähne
2 : 2 teeth
stumpf
blunt

17 cm – 6¾"

OZ-4755-17



MAYO-ADAMS

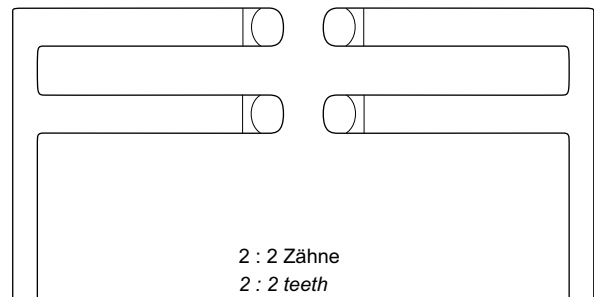
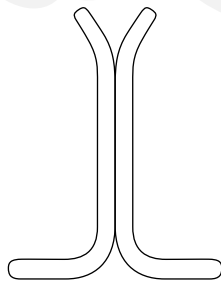

2 : 2 Zähne
2 : 2 teeth
stumpf
blunt

17 cm – 6¾"

OZ-4756-17

Wundspreizer Self-retaining Retractors

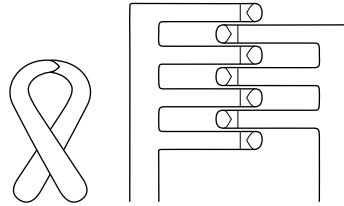

scharf
sharp

Wundsperrer komplett, bestehend aus: <i>Retractor complete, consisting of:</i>	OZ-4718-00
---	-------------------

Sperrer <i>Retractor</i>
3 Mittelvalven (OZ-4718-19, -25, -32) 3 <i>Central blades</i> (OZ-4718-19, -25, -32)



HENLEY

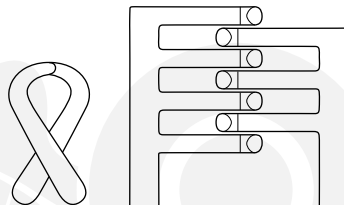

stumpf
blunt

Wundsperrer komplett, bestehend aus: <i>Retractor complete, consisting of:</i>	OZ-4718-01
---	-------------------

Sperrer <i>Retractor</i>
3 Mittelvalven (OZ-4718-19, -25, -32) 3 <i>Central blades</i> (OZ-4718-19, -25, -32)

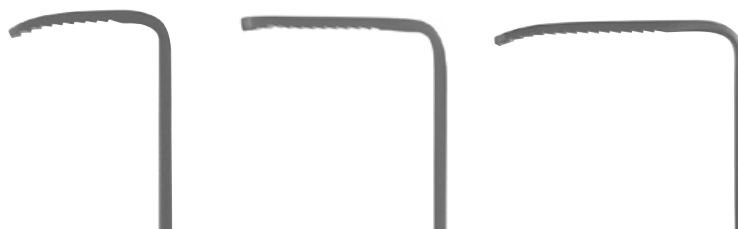

Mittelvalven
Central blades

19 x 16 mm	25 x 16 mm	32 x 16 mm
OZ-4718-19	OZ-4718-25	OZ-4718-32



Wundspreizer Self-retaining Retractors



HENLEY

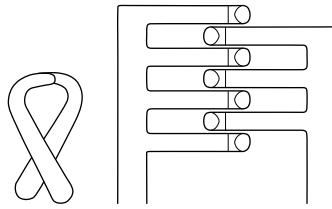

Standard

Sperrer, allein 17 cm – 6¾" <i>Retractor, only 17 cm – 6¾"</i>	OZ-4719-17
Wundsperrer komplett, bestehend aus: <i>Retractor complete, consisting of:</i>	OZ-4719-20
Sperrer allein (OZ-4719-17) <i>Retractor only (OZ-4719-17)</i>	
3 Mittelvalven (OZ-4719-21, -22, -23) <i>3 Central blades (OZ-4719-21, -22, -23)</i>	

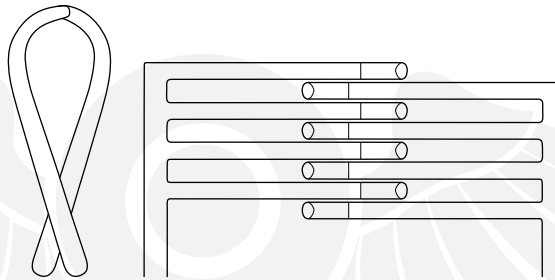

Tiefes Modell
Deep Type

Sperrer, allein 17 cm – 6¾" <i>Retractor, only 17 cm – 6¾"</i>	OZ-4719-27
Wundsperrer komplett, bestehend aus: <i>Retractor complete, consisting of:</i>	OZ-4719-30
Sperrer allein (OZ-4719-27) <i>Retractor only (OZ-4719-27)</i>	
3 Mittelvalven (OZ-4719-21, -22, -23) <i>3 Central blades (OZ-4719-21, -22, -23)</i>	



Mittelvalven
Central blades

Fig. 1	Fig. 2	Fig. 3
20 x 16 mm	25 x 16 mm	30 x 16 mm
OZ-4719-21	OZ-4719-22	OZ-4719-23



Wundspreizer Self-retaining Retractors

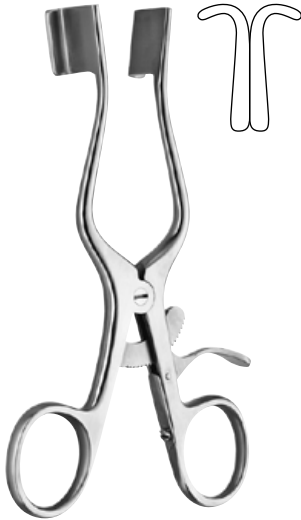

WEITLANER-BABY

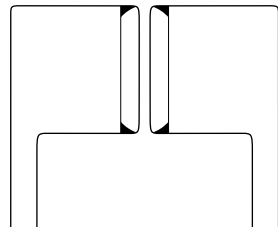

stumpf
blunt

13 cm – 5"

OZ-4719-13



MILLIGAN

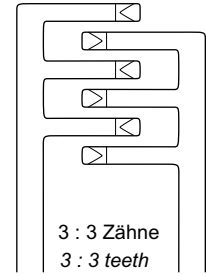

3 : 3 Zähne
3 : 3 teeth

scharf
sharp stumpf
blunt

13 cm – 5"

OZ-4720-13

OZ-4721-13



CONE (ADSON-BABY)

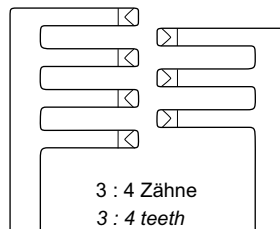

3 : 4 Zähne
3 : 4 teeth

scharf
sharp stumpf
blunt

14 cm – 5½"

OZ-4722-13

OZ-4723-13

16 cm – 6¼"

OZ-4722-16

OZ-4723-16



Wundspreizer Self-retaining Retractors



WEITLANER

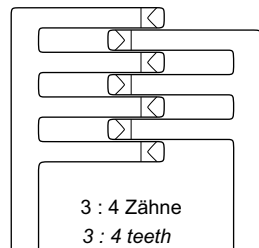

3 : 4 Zähne
3 : 4 teeth

scharf stumpf
sharp blunt

20 cm – 8"

OZ-4724-20 | **OZ-4725-20**

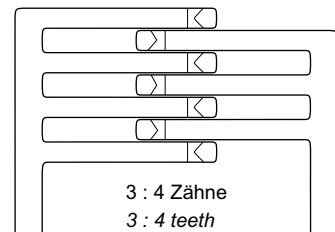

3 : 4 Zähne
3 : 4 teeth

scharf stumpf
sharp blunt

24 cm – 9½"

OZ-4724-25 | **OZ-4725-25**

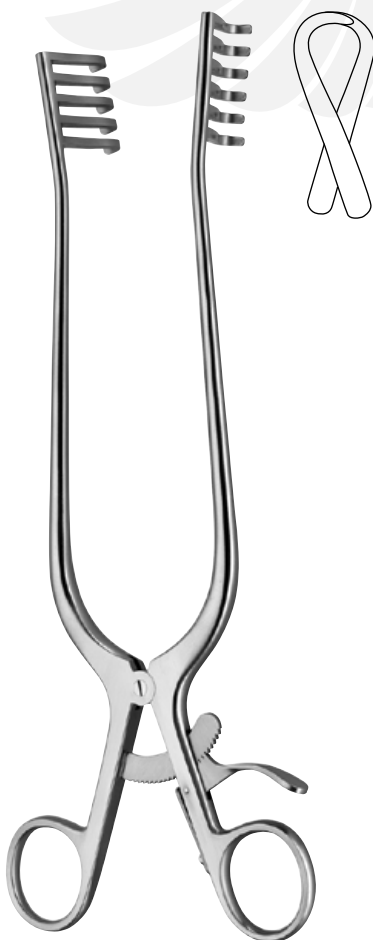

WEITLANER

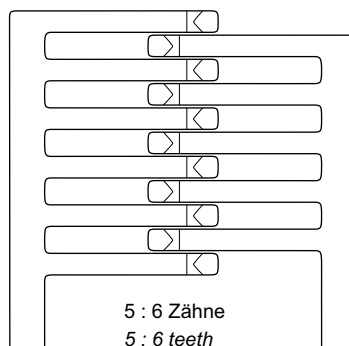

5 : 6 Zähne
5 : 6 teeth

scharf stumpf
sharp blunt

25 cm – 10"

OZ-4726-25 | **OZ-4727-25**



OZZE MEDICAL & SURGICAL SUPPLIES
TOOLS TO OPERATE

Wundspreizer Self-retaining Retractors



ADSON

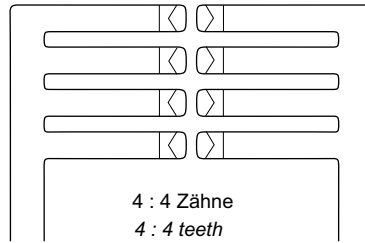

scharf stumpf
sharp blunt

19,5 cm – 7 $\frac{3}{4}$ "

OZ-4728-20 | **OZ-4729-20**



ANDERSON-ADSON

4 : 4 Zähne
4 : 4 teeth

scharf stumpf
sharp blunt

20 cm – 8"

OZ-4730-20 | **OZ-4731-20**



Wundspreizer Self-retaining Retractors



ADSON

1:3

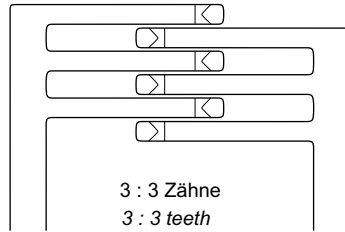
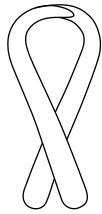

3 : 3 Zähne
3 : 3 teeth
scharf
sharp

24 cm – 9½"

OZ-4732-24



CONE

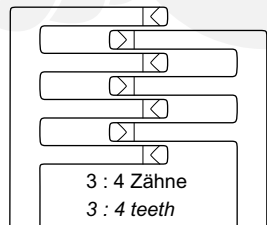

3 : 4 Zähne
3 : 4 teeth

scharf stumpf
sharp blunt

21 cm – 8¼"

OZ-4734-20 | **OZ-4735-20**

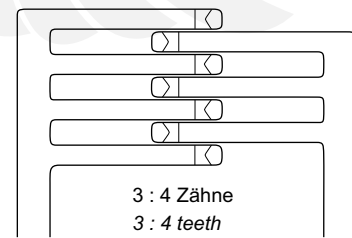

3 : 4 Zähne
3 : 4 teeth

scharf stumpf
sharp blunt

25 cm – 10"

OZ-4734-26 | **OZ-4735-26**

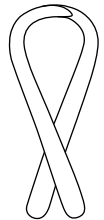



Wundspreizer Self-retaining Retractors



TRIVERS

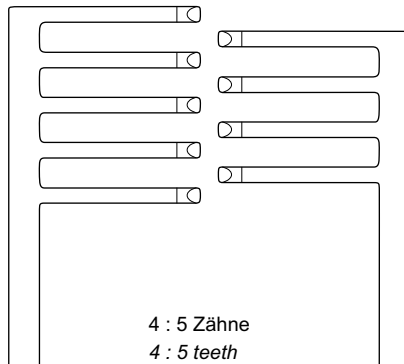
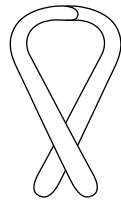

4 : 5 Zähne
4 : 5 teeth

stumpf
blunt

21 cm – 8¼"

OZ-4738-21

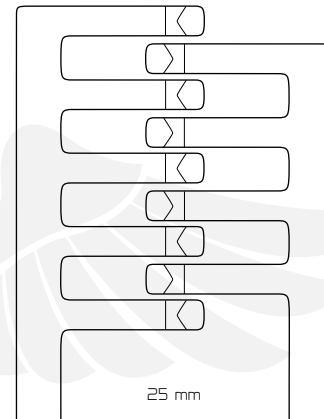

25 mm

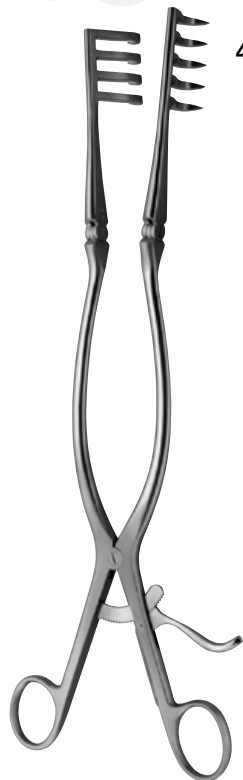

BECKMANN-ADSON

4 : 5 Zähne
4 : 5 TEETH

1:3

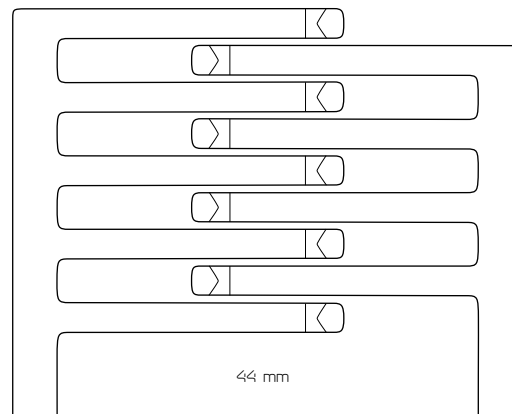

44 mm

scharf
sharp

stumpf
blunt

31 cm – 12¼"

25mm	OZ-4739-01	OZ-4739-11	OZ-4739-21
44mm	OZ-4739-02	OZ-4739-12	OZ-4739-22



Wundspreizer Self-retaining Retractors



3 : 4 Zähne
3 : 4 teeth

scharf
sharp stumpf
blunt

21 cm – 8¼"

OZ-4740-27 **OZ-4741-27**

ADSON



5 : 6 Zähne
5 : 6 teeth

scharf
sharp stumpf
blunt

27 cm – 10½"

OZ-4740-51 **OZ-4741-51**

ADSON



4 : 4 Zähne
4 : 4 teeth

scharf
sharp

stumpf
blunt

halbscharf
semisharp

31 cm – 12¼"

OZ-4742-31

OZ-4743-31

OZ-4743-41

**BECKMANN-ADSON
(STANDARD)**

1:3



OZZE MEDICAL & SURGICAL SUPPLIES
TOOLS TO OPERATE

Wundspreizer Self-retaining Retractors



ADSON

stumpf
blunt

33 cm – 13"

OZ-4743-33

1:3



Hemilaminektome-Sperrer
Hemilaminectomy retractor

scharf
sharp

28 cm – 11"

OZ-4745-27

1:3

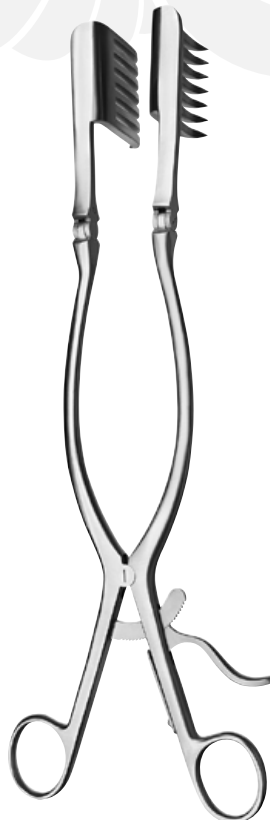

BECKMANN-EATON

scharf
sharp

33 cm – 13"

OZ-4749-33

1:3



Spezialwundspreizer Special Retractors



Schilddrüsen- und
Vulvaspreizer
*Thyroid- and vag-
inal retractor*

15,5 cm – 6"

OZ-4761-00

JOLL (FRIEDMANN)



Haut- und Vulvaspreizer
Skin- and vaginal retractor

9,5 cm – 3¾"	OZ-4761-09
12 cm – 4¾"	OZ-4761-11
13,5 cm – 5¼"	OZ-4761-13
19 cm – 7½"	OZ-4761-19

GELPI



Haut- und
Vulvaspreizer
*Skin- and
vaginal retractor*

19 cm – 7½"

OZ-4763-19

GELPI



Blätterblades | 19 cm – 7"

32 x 25 mm	OZ-4764-01
54 x 25 mm	OZ-4764-02
60 x 25 mm	OZ-4764-04

MEYERDING



Wundspreizer Self-retaining Retractors



MARHAM-MEYERDING

18 cm – 7"

OZ-4765-01



OZ-4765-02



RIGBY

19 cm – 7½"

OZ-4767-19

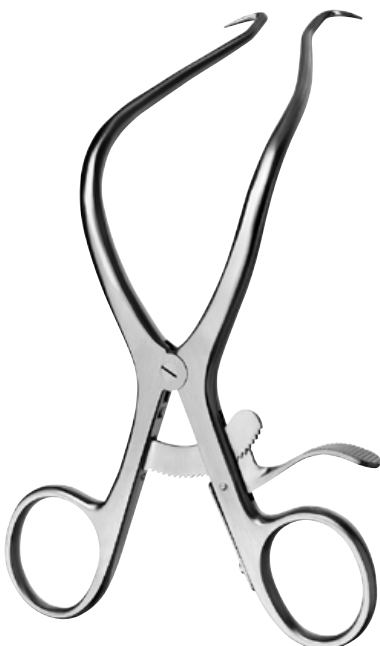

DE BAKEY

12 cm – 4¾" | **OZ-4768-12**

17 cm – 6¾" | **OZ-4768-17**



Bauchdeckenhalter Abdominal Retractors



COLLIN

Sperrer allein, Spreizweite: 100 mm <i>Retractor only, spread: 100 mm</i>	OZ-4750-50
---	-------------------

Bauchdeckenhalter komplett mit einem Paar Blätter OZ-4750-51 <i>Abdominal retractor complete with one pair of blades OZ-4750-51</i>	OZ-4750-00
---	-------------------

Blätter seitlich, 1 Paar (38 x 60 mm) Blades lateral, 1 pair (38 x 60 mm)
--

OZ-4750-51



BABY-COLLIN

Bauchdeckenhalter (Spreizweite: 80 mm) komplett mit 2 Paar Blätter (28 x 42 mm, 18 x 42 mm)	OZ-4751-00
--	-------------------

<i>Abdominal retractor (spread: 80 mm) complete with two pairs of blades (28 x 42 mm, 18 x 42 mm)</i>

Blätter seitlich, 1 Paar (18 x 42 mm) Blades lateral, 1 pair (18 x 42 mm)
--

OZ-4751-51

Blätter seitlich, 1 Paar (28 x 42 mm) Blades lateral, 1 pair (28 x 42 mm)
--

OZ-4751-52

Bauchdeckenhalter Abdominal Retractors



Fig. 1

Sperrer allein, Spreizweite: 110 mm <i>Retractor only, spread: 110 mm</i>	OZ-4752-50
---	-------------------

Bauchdeckenhalter komplett, bestehend aus: <i>Abdominal retractor complete, consisting of:</i>	OZ-4752-00
---	-------------------

Sperrer allein (OZ-4752-50) <i>Retractor only (OZ-4752-50)</i>	
---	--

- 1 Paar Blätter seitlich, 38 x 62 mm (OZ-4752-51)
- 1 pair of blades lateral, 38 x 62 mm (OZ-4752-51)
- 1 Mittelblatt, 55 x 55 mm (OZ-4752-55)
- 1 Central blade, 55 x 55 mm (OZ-4752-55)

Fig. 2

Sperrer allein, Spreizweite: 110 mm <i>Retractor only, spread: 110 mm</i>	OZ-4754-50
---	-------------------

Bauchdeckenhalter komplett, bestehend aus: <i>Abdominal retractor complete, consisting of:</i>	OZ-4754-00
---	-------------------

Sperrer allein (OZ-4754-50) <i>Retractor only (OZ-4754-50)</i>	
---	--

- 1 Paar Blätter seitlich, 38 x 80 mm (OZ-4754-51)
- 1 pair of blades lateral, 38 x 80 mm (OZ-4754-51)

Fig. 3

Sperrer allein, Spreizweite: 110 mm <i>Retractor only, spread: 110 mm</i>	OZ-4754-60
---	-------------------

Bauchdeckenhalter komplett, bestehend aus: <i>Abdominal retractor complete, consisting of:</i>	OZ-4754-10
---	-------------------

Sperrer allein (OZ-4754-60) <i>Retractor only (OZ-4754-60)</i>	
---	--

- 1 Paar Blätter seitlich, 38 x 100 mm (OZ-4754-61)
- 1 pair of blades lateral, 38 x 100 mm (OZ-4754-61)
- 1 Mittelblatt, 55 x 75 mm (OZ-4754-65)
- 1 Central blade, 55 x 75 mm (OZ-4754-65)

Bauchdeckenhalter Abdominal Retractors

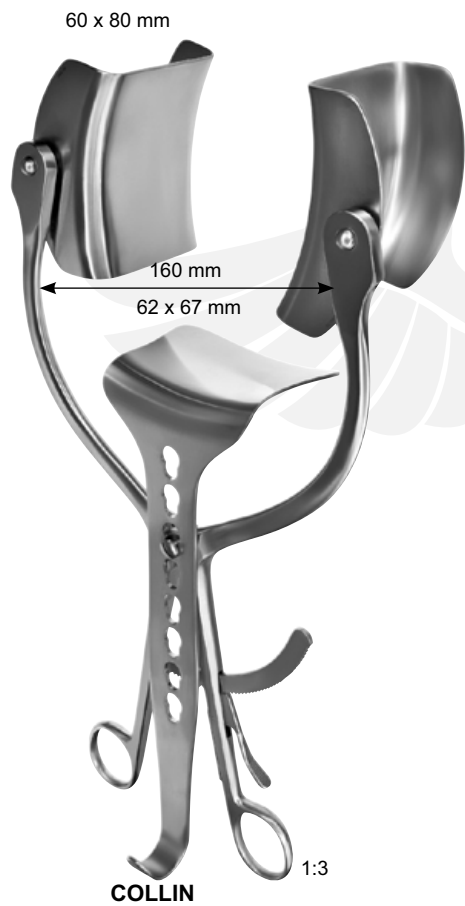

Sperrer allein
Retractor only

OZ-4754-76

Bauchdeckenhalter komplett, bestehend aus:
Abdominal retractor complete, consisting of:

OZ-4754-70

Sperrer allein (OZ-4754-76)
Retractor only (OZ-4754-76)

1 Paar Blätter seitlich, 60 x 80 mm (OZ-4754-71)

1 pair of blades lateral, 60 x 80 mm (OZ-4754-71)

1 Mittelblatt, 62 x 67 mm (OZ-4754-75)

1 Central blade, 62 x 67 mm (OZ-4754-75)

Bauchdeckenhalter Abdominal Retractors



Fig. 1

Sperrer allein <i>Retractor only</i>	OZ-4758-11
Bauchdeckenhalter komplett, bestehend aus: <i>Abdominal retractor complete, consisting of:</i>	OZ-4758-01
Sperrer allein (OZ-4758-11) <i>Retractor only (OZ-4758-11)</i>	
1 Paar Blätter seitlich, 60 x 80 mm (OZ-4758-21) 1 pair of blades lateral, 60 x 80 mm (OZ-4758-21)	
1 Mittelblatt, 53 x 70 mm (OZ-4758-31) 1 Central blade, 53 x 70 mm (OZ-4758-31)	

Fig. 2

Sperrer allein <i>Retractor only</i>	OZ-4758-11
Bauchdeckenhalter komplett, bestehend aus: <i>Abdominal retractor complete, consisting of:</i>	OZ-4758-02
Sperrer allein (OZ-4758-11) <i>Retractor only (OZ-4758-11)</i>	
1 Paar Blätter seitlich, 72 x 85 mm (OZ-4758-22) 1 pair of blades lateral, 72 x 85 mm (OZ-4758-22)	
1 Mittelblatt, 80 x 90 mm (OZ-4758-32) 1 Central blade, 80 x 90 mm (OZ-4758-32)	



Bauchdeckenhalter Abdominal Retractors

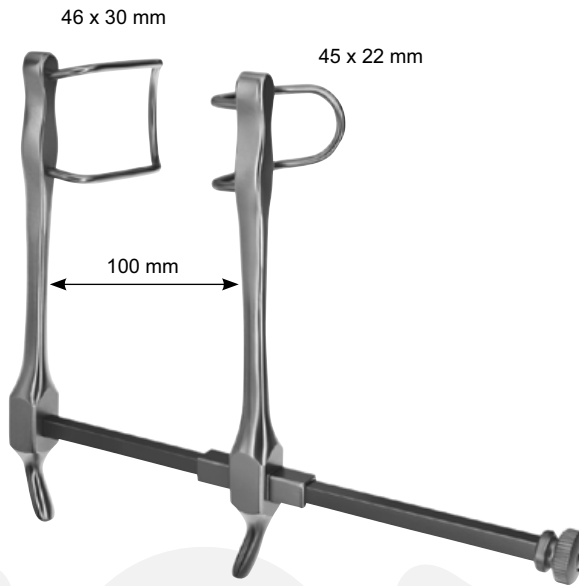

GOSSET
OZ-4769-00

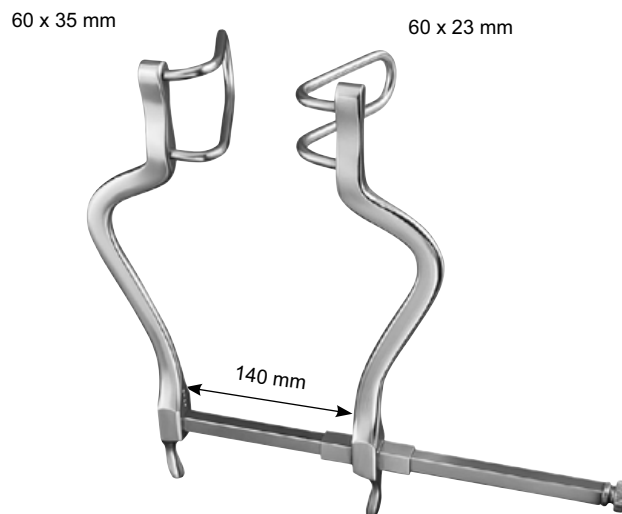
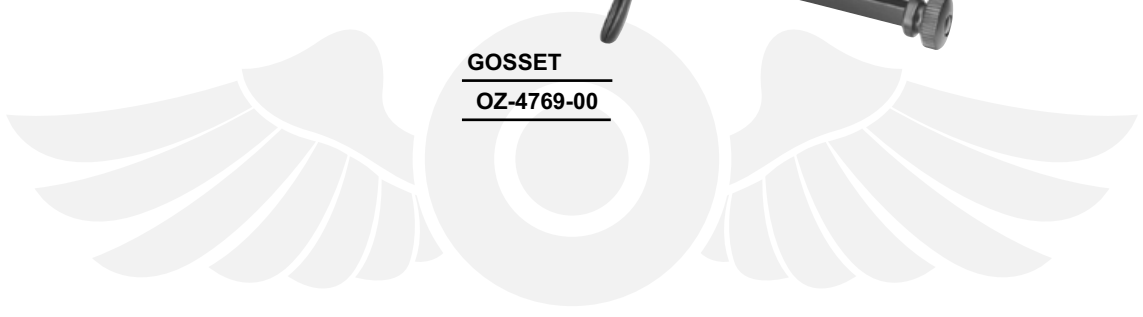

GOSSET
OZ-4770-02



Bauchdeckenhalter Abdominal Retractors



GOSSET

Sperrer allein
Retractor only

OZ-4771-11

Bauchdeckenhalter komplett, bestehend aus:
Abdominal retractor complete, consisting of:

OZ-4771-00

Sperrer allein (OZ-4771-11)
Retractor only (OZ-4771-11)

1 Mittelblatt, 65 x 60 mm (OZ-4771-21)

1 Central blade, 65 x 60 mm (OZ-4771-21)

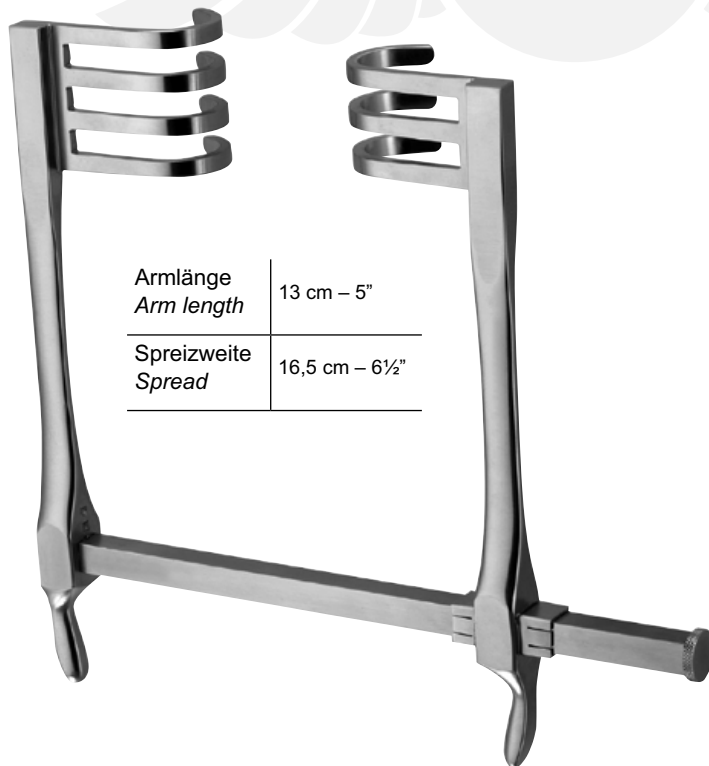

Armlänge <i>Arm length</i>	13 cm – 5"
Spreizweite <i>Spread</i>	16,5 cm – 6½"

FRAZIER

OZ-4774-00



Bauchdeckenhalter Abdominal Retractors

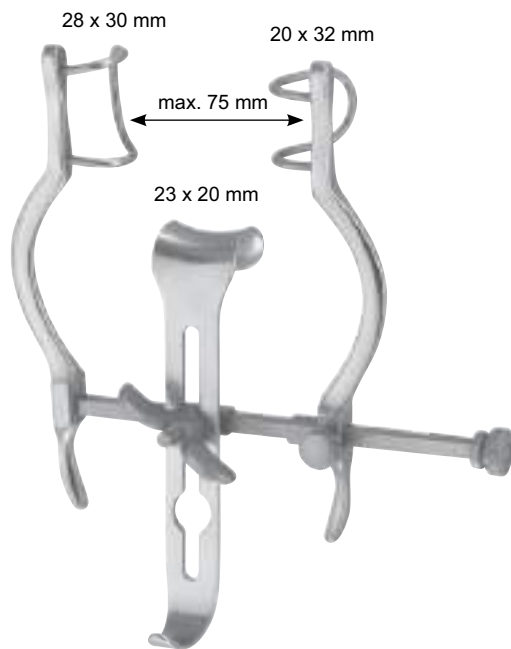

BABY-BALFOUR

Sperrer allein, Spreizweite: 75 mm <i>Retractor only, Spread: 75 mm</i>	OZ-4798-11
---	-------------------

Sperrer komplett, bestehend aus: <i>Retractor complete, consisting of:</i>	OZ-4798-00
---	-------------------

Sperrer allein (OZ-4798-11)
Retractor only (OZ-4798-11)
Mittelblatt (OZ-4798-21)
Central blade (OZ-4798-21)

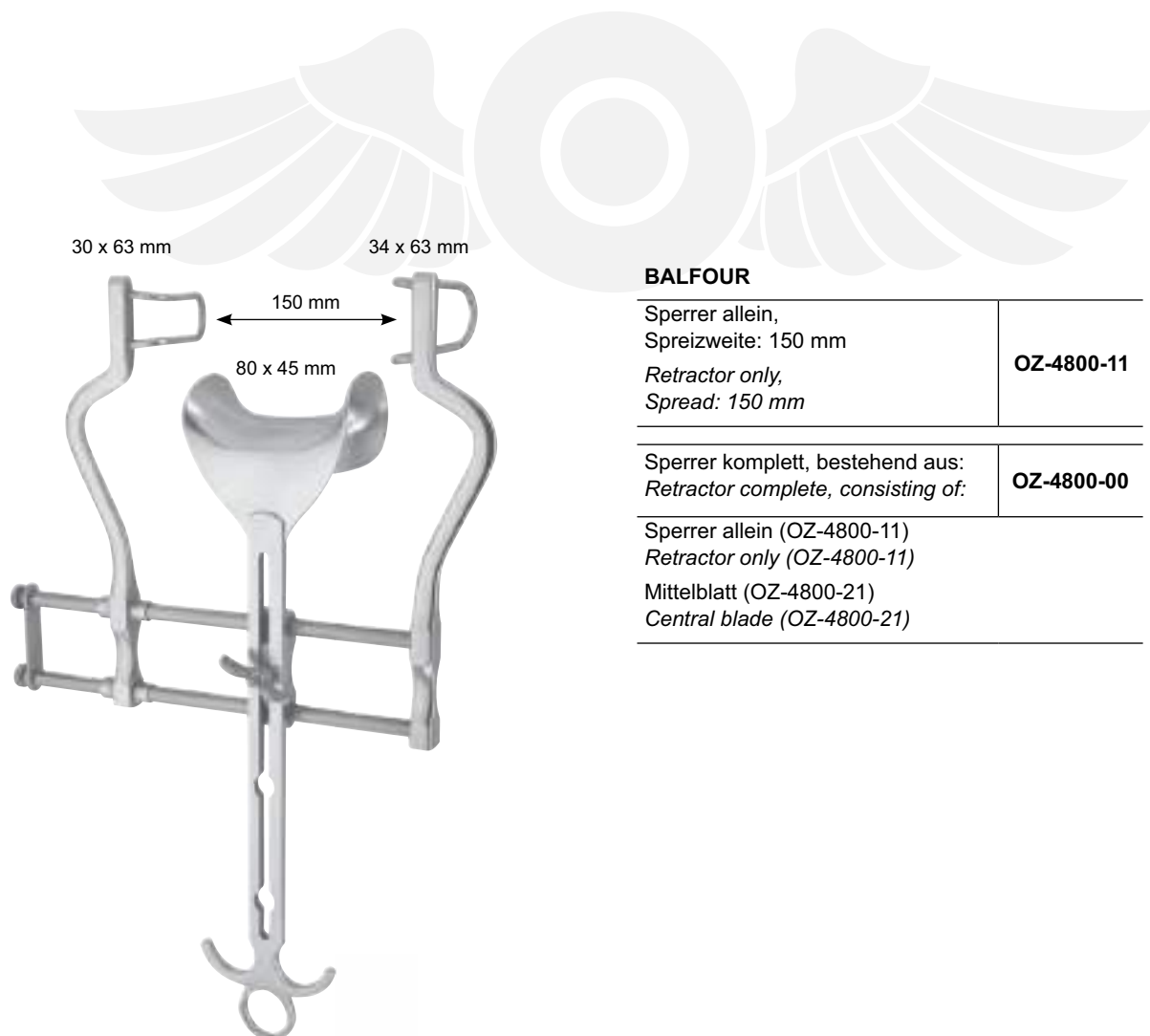

BALFOUR

Sperrer allein, Spreizweite: 150 mm <i>Retractor only, Spread: 150 mm</i>	OZ-4800-11
---	-------------------

Sperrer komplett, bestehend aus: <i>Retractor complete, consisting of:</i>	OZ-4800-00
---	-------------------

Sperrer allein (OZ-4800-11)
Retractor only (OZ-4800-11)
Mittelblatt (OZ-4800-21)
Central blade (OZ-4800-21)



Bauchdeckenhalter Abdominal Retractors

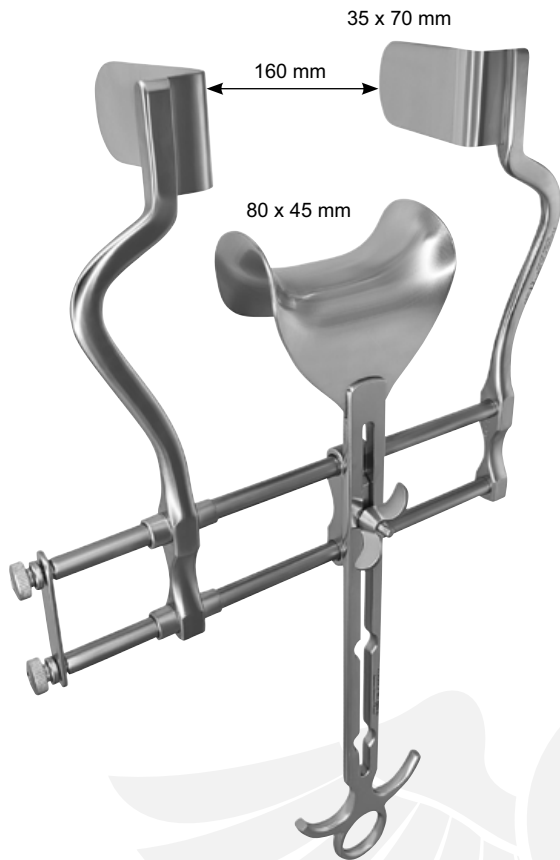

BALFOUR

Sperrer allein, Spreizweite: 160 mm <i>Retractor only, spread: 160 mm</i>	OZ-4802-11
---	-------------------

Sperrer komplett, bestehend aus: <i>Retractor complete, consisting of:</i>	OZ-4802-00
---	-------------------

Sperrer allein (OZ-4802-11)
Retractor only (OZ-4802-11)
Mittelblatt (OZ-4802-21)
Central blade (OZ-4802-21)

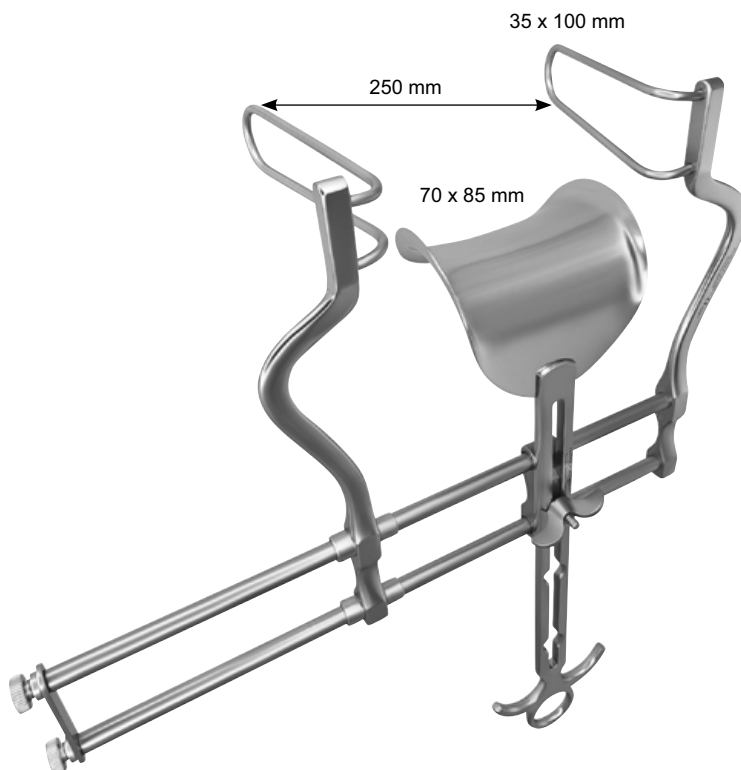

BALFOUR

Sperrer allein, Spreizweite: 250 mm <i>Retractor only, spread: 250 mm</i>	OZ-4804-11
---	-------------------

Sperrer komplett, bestehend aus: <i>Retractor complete, consisting of:</i>	OZ-4804-00
---	-------------------

Sperrer allein (OZ-4804-11)
Retractor only (OZ-4804-11)
Mittelblatt (OZ-4804-21)
Central blade (OZ-4804-21)



Bauchdeckenhalter Abdominal Retractors

100 x 35 mm

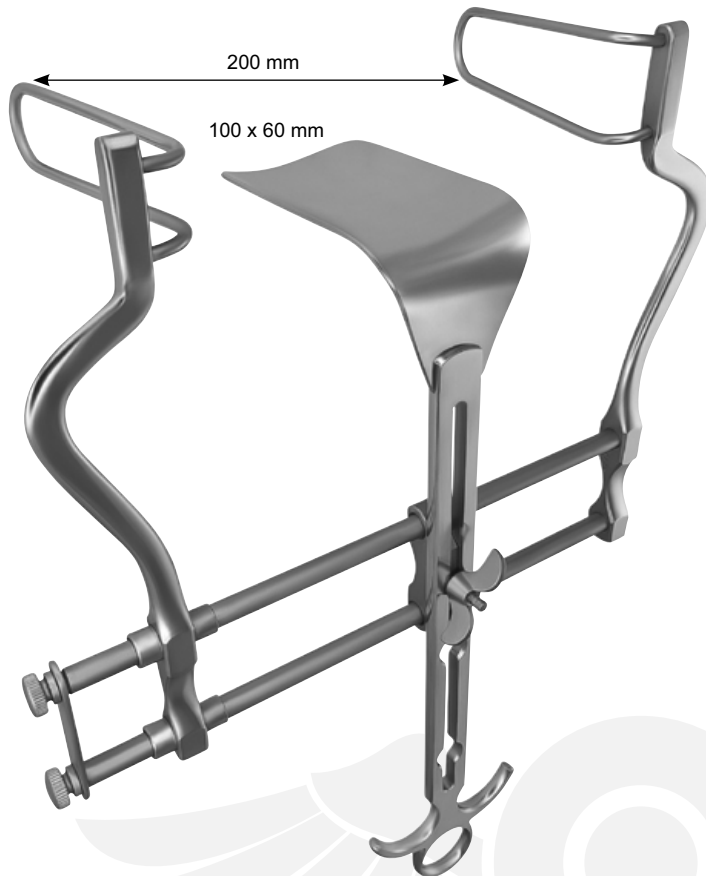

BALFOUR

Sperrer allein,
Spreizweite: 200 mm

OZ-4806-11

*Retractor only,
Spread: 200 mm*

Sperrer komplett, bestehend aus:
Retractor complete, consisting of:

OZ-4806-00

Sperrer allein (OZ-4806-11)
Retractor only (OZ-4806-11)

Mittelblatt (OZ-4806-21)
Central blade (OZ-4806-21)



BALFOUR USA-MODELL BALFOUR USA-PATTERN

Sperrer allein
Retractor only

OZ-4807-11

Sperrer komplett, bestehend aus:
Retractor complete, consisting of:

OZ-4807-00

Sperrer allein (OZ-4807-11)
Retractor only (OZ-4807-11)

2 Blätter seitlich, 60 mm (OZ-4807-31)
2 Blades lateral, 60 mm (OZ-4807-31)

2 Blätter seitlich, 80 mm (OZ-4807-32)
2 Blades lateral, 80 mm (OZ-4807-32)

1 Mittelblatt, 45 x 68 mm (OZ-4807-21)

1 Central blade, 45 x 68 mm (OZ-4807-21)

1 Mittelblatt, 68 x 85 mm (OZ-4807-22)

1 Central blade, 68 x 85 mm (OZ-4807-22)

Bauchdeckenhalter Abdominal Retractors

SEMM

Bauchdeckenhalter komplett,
bestehend aus:

*Abdominal retractor complete,
consisting of:*

OZ-4810-00

Rahmen (OZ-4810-10)
Frame (OZ-4810-10)

2 Blätter (OZ-4810-01)
2 Blades (OZ-4810-01)

1 Blätter (OZ-4810-02)
1 Blades (OZ-4810-02)

1 Blätter (OZ-4810-03)
1 Blades (OZ-4810-03)

1 Blätter (OZ-4810-04)
1 Blades (OZ-4810-04)

1 Blätter (OZ-4810-05)
1 Blades (OZ-4810-05)

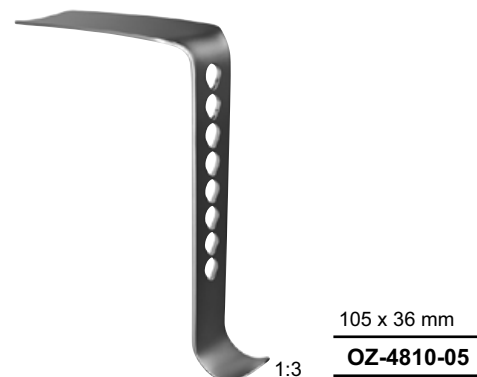
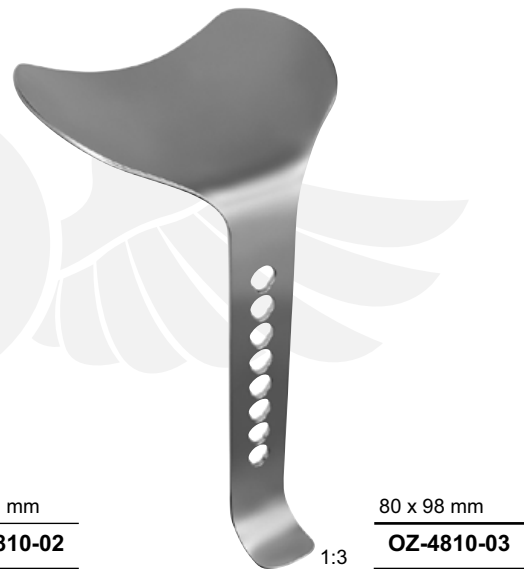
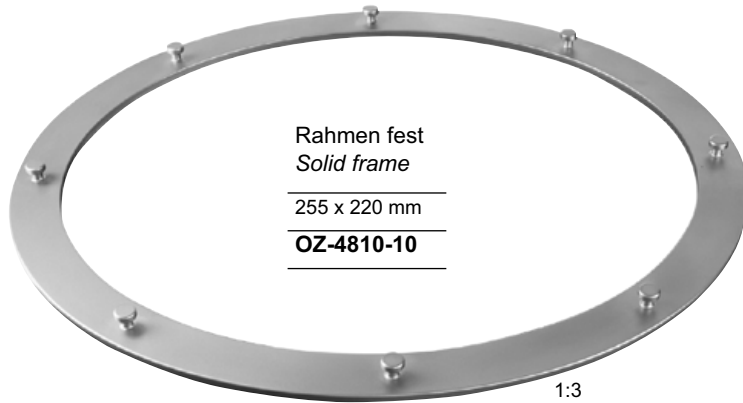



Bauchdeckenhalter Abdominal Retractors

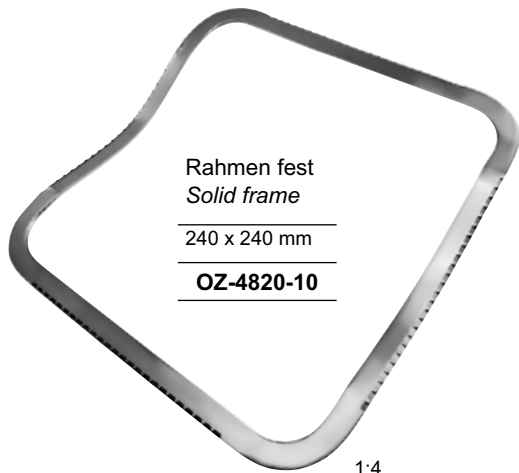

Rahmen fest
Solid frame

240 x 240 mm

OZ-4820-10

1:4

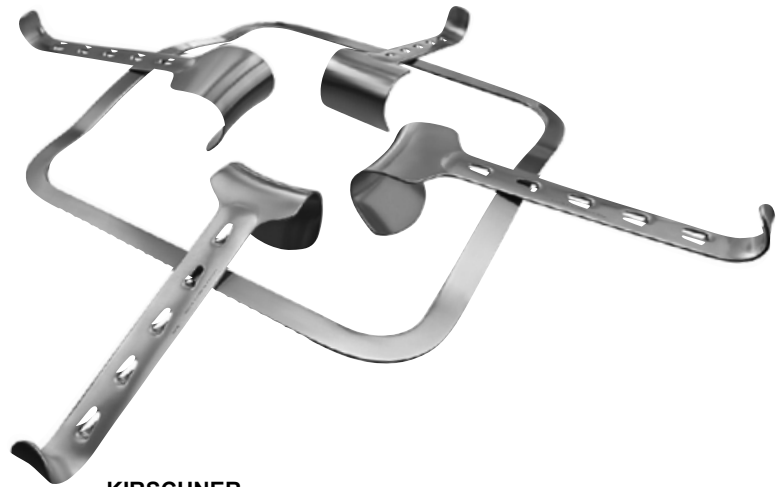

KIRSCHNER

Bauchdeckenhalter komplett, bestehend aus:
Abdominal retractor complete, consisting of:

OZ-4820-00

Rahmen fest (OZ-4820-10)
Solid frame (OZ-4820-10)

2 Blätter, 40 x 55 mm (OZ-4822-01)
2 Blades, 40 x 55 mm (OZ-4822-01)

2 Blätter, 50 x 65 mm (OZ-4822-02)
2 Blades, 50 x 65 mm (OZ-4822-02)

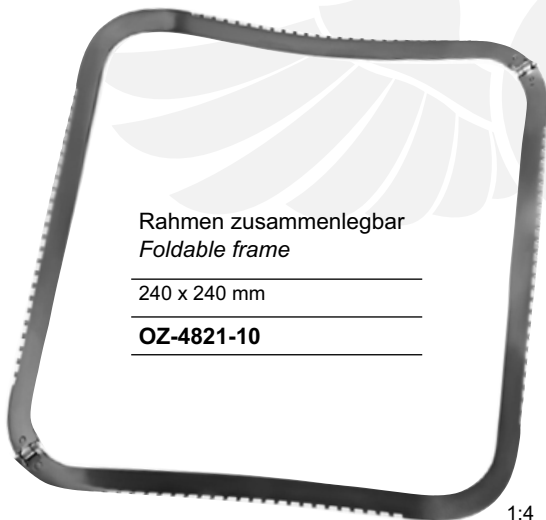

Rahmen zusammenlegbar
Foldable frame

240 x 240 mm

OZ-4821-10

1:4

KIRSCHNER

Bauchdeckenhalter komplett, bestehend aus:
Abdominal retractor complete, consisting of:

OZ-4821-00

Rahmen zusammenlegbar (OZ-4821-10)
Foldable frame (OZ-4821-10)

2 Blätter, 40 x 55 mm (OZ-4822-01)
2 Blades, 40 x 55 mm (OZ-4822-01)

2 Blätter, 50 x 65 mm (OZ-4822-02)
2 Blades, 50 x 65 mm (OZ-4822-02)



1:3

	Blätter Blades
40 x 55 mm	OZ-4822-01
50 x 65 mm	OZ-4822-02
65 x 80 mm	OZ-4822-03
80 x 80 mm	OZ-4822-04
90 x 65 mm	OZ-4822-05
90 x 90 mm	OZ-4822-06

Bauchdeckenhalter Abdominal Retractors



DENIS-BROWN

Bauchdeckenhalter komplett, bestehend aus: <i>Abdominal retractor complete, consisting of:</i>	OZ-4826-00
---	-------------------

Rahmen 178 x 140 mm (OZ-4826-10) Frame 178 x 140 mm (OZ-4826-10)
2 Blätter, Fig. 1, 40 x 40 mm (OZ-4828-01) 2 Blades, fig. 1, 40 x 40 mm (OZ-4828-01)
2 Blätter, Fig. 2, 40 x 30 mm (OZ-4828-02) 2 Blades, fig. 2, 40 x 30 mm (OZ-4828-02)

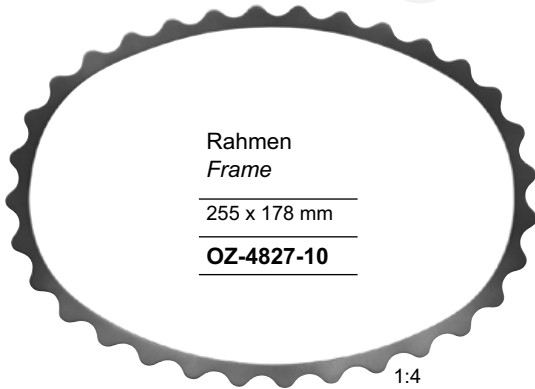
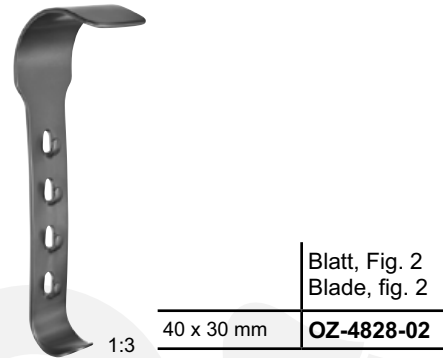
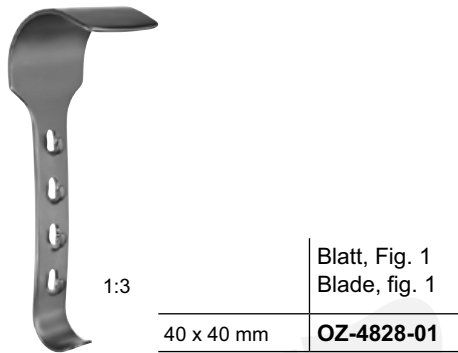

DENIS-BROWN

Bauchdeckenhalter komplett, bestehend aus: <i>Abdominal retractor complete, consisting of:</i>	OZ-4827-00
---	-------------------

Rahmen 255 x 178 mm (OZ-4827-10) Frame 255 x 178 mm (OZ-4827-10)
2 Blätter, Fig. 1, 40 x 40 mm (OZ-4828-01) 2 Blades, fig. 1, 40 x 40 mm (OZ-4828-01)
2 Blätter, Fig. 2, 40 x 30 mm (OZ-4828-02) 2 Blades, fig. 2, 40 x 30 mm (OZ-4828-02)

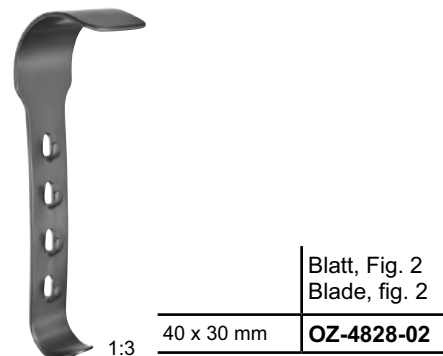



Bauchdeckenhalter Abdominal Retractors

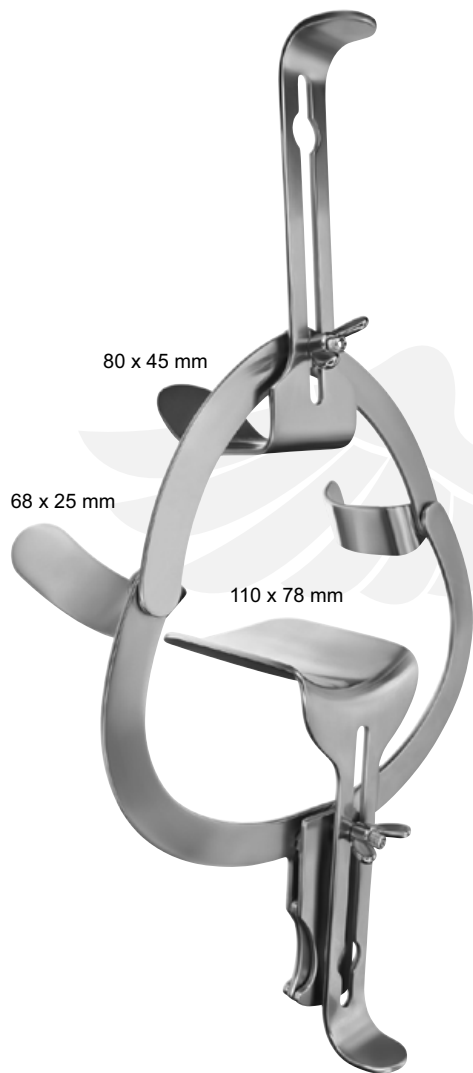

O'SULLIVAN-O'CONNOR

Bauchdeckenhalter komplett, bestehend aus:
Abdominal retractor complete, consisting of:

OZ-4829-00

2 Mittelblätter, 80 x 45 mm (OZ-4829-22)
2 Central blades, 80 x 45 mm (OZ-4829-22)

1 Mittelblatt, 110 x 70 mm (OZ-4829-23)
1 Central blade, 110 x 70 mm (OZ-4829-23)



80 x 45 mm
OZ-4829-22

110 x 70 mm
OZ-4829-23



Bauchdeckenhalter Abdominal Retractors

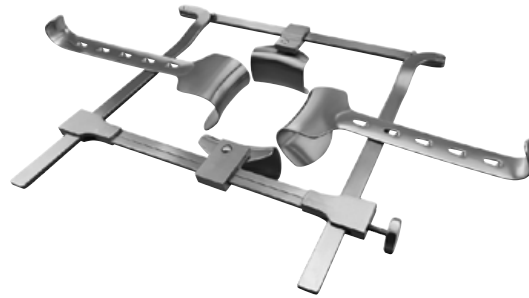

FRANZ

Bauchdeckenhalter komplett,
bestehend aus:

*Abdominal retractor complete,
consisting of:*

OZ-4830-04

Rahmen zusammenlegbar (OZ-4830-10)
Foldable frame (OZ-4830-10)

2 Blätter, 38 x 60 mm (OZ-4832-01)

2 Blades, 38 x 60 mm (OZ-4832-01)

2 Blätter, 50 x 65 mm (OZ-4833-01)

2 Blades, 50 x 65 mm (OZ-4833-01)

FRANZ

Bauchdeckenhalter komplett,
bestehend aus:

*Abdominal retractor complete,
consisting of:*

OZ-4830-08

Rahmen zusammenlegbar (OZ-4830-10)
Foldable frame (OZ-4830-10)

2 Blätter, 38 x 60 mm (OZ-4832-01)

2 Blades, 38 x 60 mm (OZ-4832-01)

2 Blätter, 50 x 65 mm (OZ-4833-01)

2 Blades, 50 x 65 mm (OZ-4833-01)

2 Blätter, 45 x 80 mm (OZ-4832-02)

2 Blades, 45 x 80 mm (OZ-4832-02)

2 Blätter, 60 x 85 mm (OZ-4833-02)

2 Blades, 60 x 85 mm (OZ-4833-02)

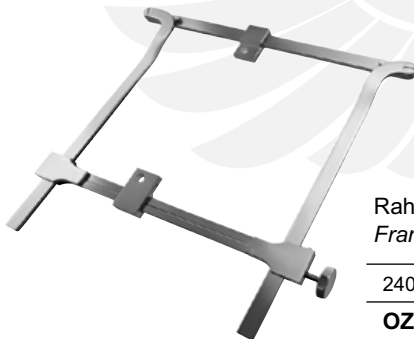

Rahmen
Frame

240 x 300 mm

OZ-4830-10



1:3

Blätter
Blades

38 x 60 mm

OZ-4832-01

45 x 80 mm

OZ-4832-02



1:3

Blätter
Blades

50 x 65 mm

OZ-4833-01

60 x 85 mm

OZ-4833-02

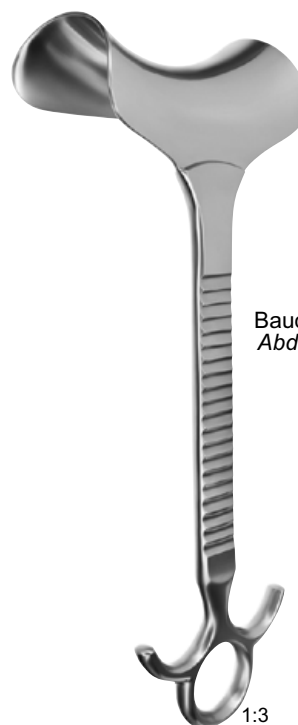

1:3

Bauchdeckenhalter
Abdominal retractor

48 x 90 mm

OZ-4834-01

48 x 105 mm

OZ-4834-02

48 x 120 mm

OZ-4834-03

48 x 135 mm

OZ-4834-04

DOYEN



Bauchdeckenhalter Abdominal Retractors



Befestigungsgestell
Mounting frame

1:6
ROCHARD
OZ-4835-01

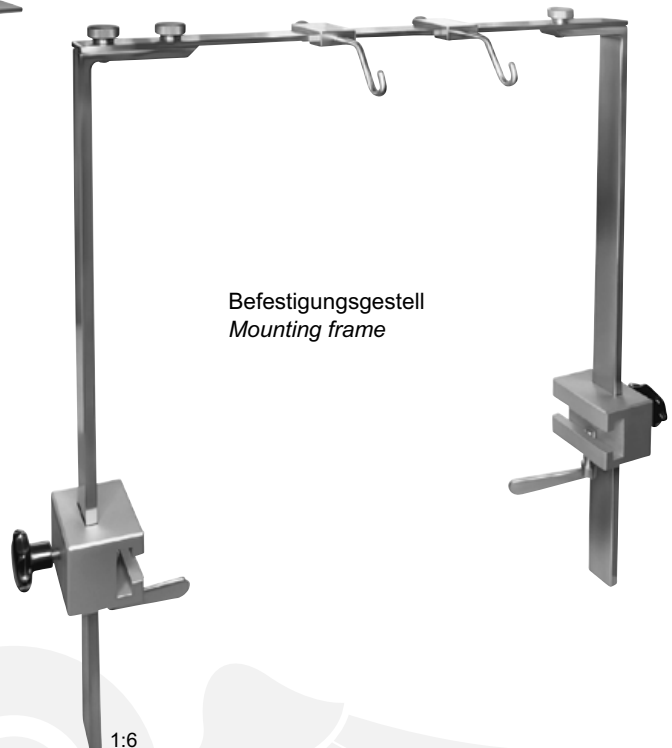

Befestigungsgestell
Mounting frame

1:6
ROCHARD
OZ-4835-02



Fixiervorrichtung
Fixation device

1:3
ROCHARD
OZ-4835-03

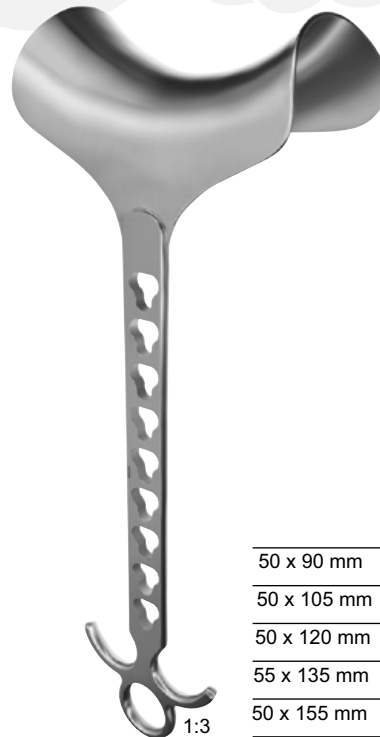

1:3
ROCHARD

	Blätter Blades
50 x 90 mm	OZ-4835-09
50 x 105 mm	OZ-4835-10
50 x 120 mm	OZ-4835-12
55 x 135 mm	OZ-4835-13
50 x 155 mm	OZ-4835-15



OZZE MEDICAL & SURGICAL SUPPLIES

TOOLS TO OPERATE

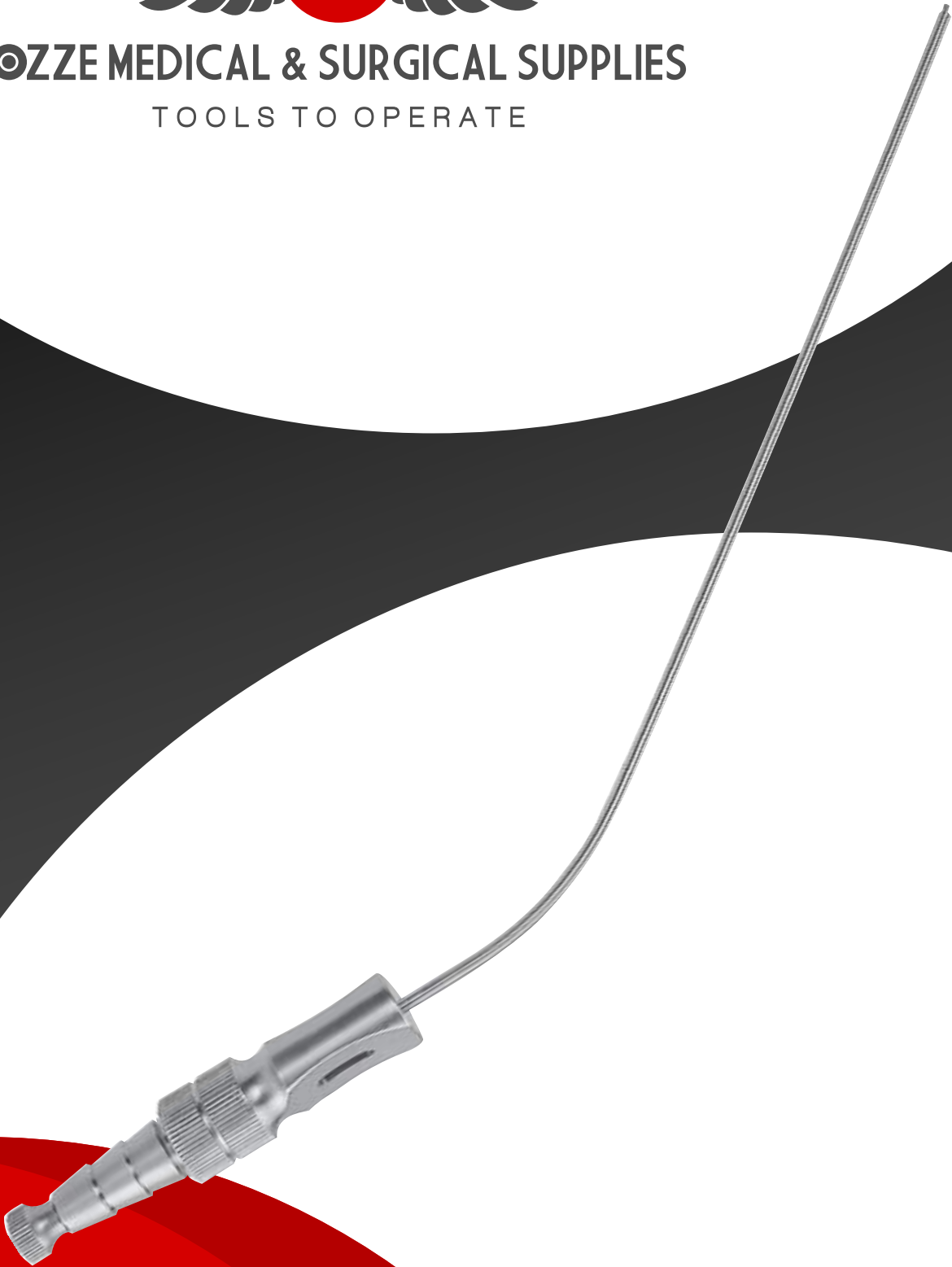

SIX

🖱 www.ozzesurgical.com.au

✉ info@ozzesurgical.com.au



OZZE MEDICAL & SURGICAL SUPPLIES
TOOLS TO OPERATE

Trokare, Saug- und
Spülinstrumente, Sonden, Watteträger
Trocars, Suction and Irrigation Instruments,
Probes, Cotton Applicators

Trokare	<i>Trocars</i>	TS 1 - 2
Kanülen	<i>Cannulas</i>	TS 3 - 7
Saug-Raspatorien, Saug-Dissektoren	<i>Suction Raspatories, Suction Dissectors</i>	TS 8
Mikro-Saugkanülen	<i>Micro Suction Tubes</i>	TS 9
Katheterzangen	<i>Catheter Forceps</i>	TS 10
Spritzen	<i>Syringes</i>	TS 11
Luer-Lock Adapter	<i>Luer-Lock Adapter</i>	TS 12
Führungsnadeln	<i>Guide Needles</i>	TS 13
Sonden	<i>Probes</i>	TS 14 - 17
Watteträger	<i>Cotton Applicators</i>	TS 18 - 20



NELSON

Gesamtlänge <i>Total length</i>	Nutzlänge <i>Working length</i>	Außen-Ø <i>Outer-Ø</i>	Innen-Ø <i>Inner-Ø</i>	
17,5 cm – 7"	7,5 cm – 3"	3 mm	2,2 mm	OZ-5200-30
	7,5 cm – 3"	3,5 mm	2,5 mm	OZ-5200-35
	7,5 cm – 3"	4 mm	3 mm	OZ-5200-40
	7,5 cm – 3"	4,5 mm	3,5 mm	OZ-5200-45
	8 cm – 3¼"	5 mm	4 mm	OZ-5200-50
	8 cm – 3¼"	5,5 mm	4,5 mm	OZ-5200-55
	8,5 cm – 3¼"	6 mm	5 mm	OZ-5200-60

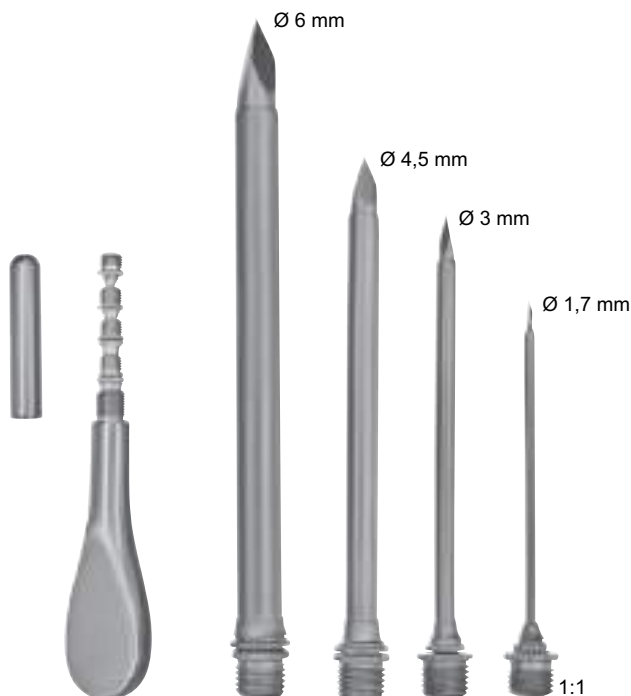

UNIVERSAL

Trokar-Set komplett, bestehend aus: <i>Trocar set complete, consisting of:</i>	OZ-5212-04
---	-------------------

- 1 Griff, flach
- 1 Handle, flat
- 1 Trokar Ø 1,7 mm
- 1 Trocar Ø 1.7 mm
- 1 Trokar Ø 3 mm
- 1 Trocar Ø 3 mm
- 1 Trokar Ø 4,5 mm
- 1 Trocar Ø 4.5 mm
- 1 Trokar Ø 6 mm
- 1 Trocar Ø 6 mm



Trokare Trocars

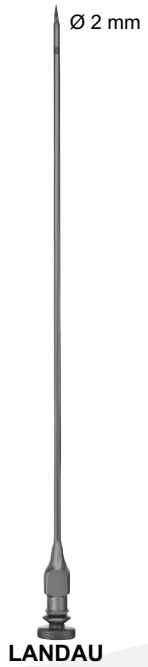

mit Luer-Lock Ansatz
with Luer-Lock hub

16 cm – 6¼"
OZ-5220-16

LANDAU



14 cm – 5½"
OZ-5232-16

PEAN



Ø mm	15 cm – 6"
4	OZ-5250-40
4,6	OZ-5250-46
5,5	OZ-5250-55
6,5	OZ-5250-65

OCHSNER

Ø 10 mm mit zentraler Bohrung Ø 2 mm
 Ø 10 mm with central hole Ø 2 mm



27 cm – 10½"
OZ-5260-27

1:3
YANKAUER-STANDARD

Ø 5 mm



22,5 cm – 8¾"
OZ-5265-00

1:3
ANDREW-PYNCHON

Ø 10 mm



22 cm – 8¾"
OZ-5280-22

1:3
POOLE

Ø 8 mm



22 cm – 8¾"
OZ-5281-22

1:3
POOLE



Kanülen Cannulas

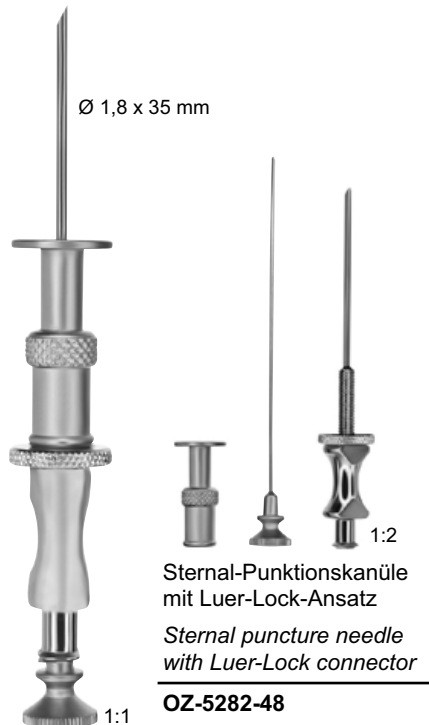

KLIMA-ROSEGGER

isoliert, mit Saugunterbrecher und Mandrel
insulated, with cut-off and stylet



FERGUSSON

		Arbeitslänge Working length
Ø mm	Charr./Fr.	90 mm – 3½"
4	12	OZ-6421-34

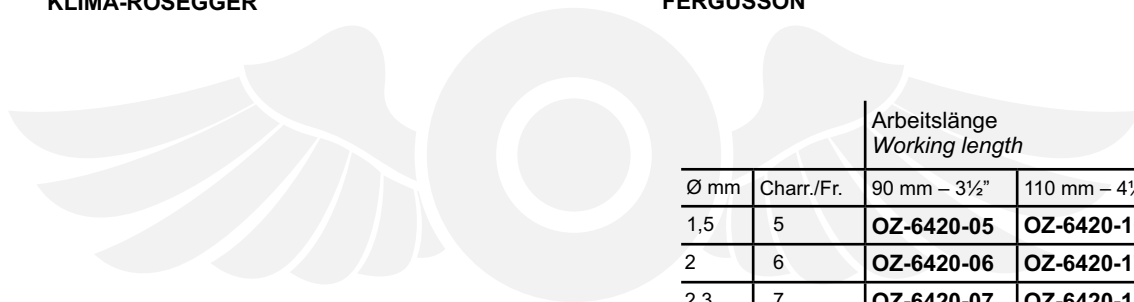

		Arbeitslänge Working length		
Ø mm	Charr./Fr.	90 mm – 3½"	110 mm – 4¼"	130 mm – 5"
1,5	5	OZ-6420-05	OZ-6420-16	OZ-6420-25
2	6	OZ-6420-06	OZ-6420-17	OZ-6420-26
2,3	7	OZ-6420-07	OZ-6420-18	OZ-6420-27
2,5	8	OZ-6420-08	OZ-6420-19	OZ-6420-28
3	9	OZ-6420-09	OZ-6420-20	OZ-6420-29
3,3	10	OZ-6420-10	OZ-6420-21	OZ-6420-30
3,5	11	OZ-6420-11	OZ-6420-22	OZ-6420-31
4	12	OZ-6420-12	OZ-6420-23	OZ-6420-32
5	15	OZ-6420-15	OZ-6420-24	OZ-6420-33

mit Saugunterbrecher und Mandrel
with cut-off and stylet



FRAZIER (FERGUSSON)

		Arbeitslänge Working length	
Ø mm	Charr./Fr.	150 mm – 6"	190 mm – 7½"
1,5	5	OZ-6420-34	OZ-6420-43
2	6	OZ-6420-35	OZ-6420-44
2,3	7	OZ-6420-36	OZ-6420-45
2,5	8	OZ-6420-37	OZ-6420-46
3	9	OZ-6420-38	OZ-6420-47
3,3	10	OZ-6420-39	OZ-6420-48
3,5	11	OZ-6420-40	OZ-6420-49
4	12	OZ-6420-41	OZ-6420-50
5	15	OZ-6420-42	OZ-6420-51



Kanülen Cannulas

olivenförmig
olive-shaped



FRAZIER

		Arbeitslänge Working length
Ø mm	Charr./Fr.	100 mm – 4"
2	6	OZ-6420-56
2,5	8	OZ-6420-58
3,3	10	OZ-6420-60
4	12	OZ-6420-62
5	15	OZ-6420-65

Abstandsmarkierungen bei 5 - 9 cm
Calibrations marked at 5 - 9 cm



FRAZIER

mit Saugunterbrecher und Mandrel
with with cut-off and stylet

		Arbeitslänge Working length
Ø mm	Charr./Fr.	100 mm – 4"
2	6	OZ-6420-76
2,5	8	OZ-6420-78
3,3	10	OZ-6420-80
4	12	OZ-6420-82
5	15	OZ-6420-85



mit Saugunterbrecher und Mandrel
with cut-off and stylet

145 mm – 5¾"



FERGUSSON

mit Mandrel
with stylet

90°

		Arbeitslänge Working length
Ø mm	Charr./Fr.	100 mm – 4"
2	6	OZ-6421-06
2,3	7	OZ-6421-07
2,5	8	OZ-6421-08
3	9	OZ-6421-09
3,3	10	OZ-6421-10
3,5	11	OZ-6421-11
4	12	OZ-6421-12
5	15	OZ-6421-15



ADSON

		Arbeitslänge Working length
Ø mm	Charr./Fr.	145 mm – 5¾"
4	12	OZ-6426-21



Kanülen Cannulas

mit Langloch Saugunterbrecher und Mandrel
with elongated cut-off and stylet



45°

POP PEN

Saugrohr, keramikbeschichtet
suction tube, ceramic coated



Arbeitslänge
Working length

Ø mm	Charr./Fr.	Arbeitslänge <i>Working length</i>	
		90 mm – 3½"	145 mm – 5¾"
2	6	OZ-6426-50	OZ-6426-60
2,3	7	OZ-6426-51	OZ-6426-61
2,5	8	OZ-6426-52	OZ-6426-62
3	9	OZ-6426-53	OZ-6426-63
3,3	10	OZ-6426-54	OZ-6426-64
3,5	11	OZ-6426-55	OZ-6426-65
4	12	OZ-6426-56	OZ-6426-66
5	15	OZ-6426-57	OZ-6426-67



Arbeitslänge
Working length

Ø mm	Charr./Fr.	160 mm – 6"
3	9	OZ-6427-100



Arbeitslänge
Working length

Ø mm	Charr./Fr.	160 mm – 6"
3	9	OZ-6427-130



Kanülen Cannulas

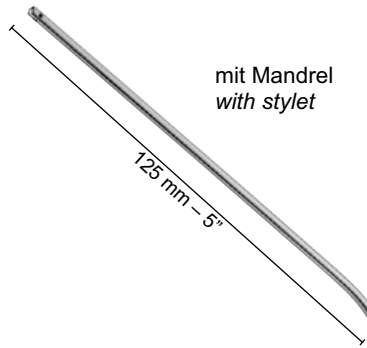

mit Mandrel
with stylet

125 mm - 5"

		Arbeitslänge Working length
Ø mm	Charr./Fr.	125 mm - 5"
1,5	5	OZ-6427-01
2,3	7	OZ-6427-02
3	9	OZ-6427-03
4	12	OZ-6427-04

MC CULLOCH

mit Mandrel
with stylet



BARON

Olive
Olive
Ø 8 mm

		Arbeitslänge Working length
Ø mm	Charr./Fr.	70 mm - 2¾"
1	3	OZ-7845-03
1,5	5	OZ-7845-05
2,3	7	OZ-7845-07

Nadelsauger
Suction needle



SCHUKNECHT

Olive
Olive
Ø 8 mm

		Arbeitslänge Working length
Ø mm	Gauges	80 mm - 3¼"
0,9	20	OZ-7845-20
0,7	22	OZ-7845-22
0,5	24	OZ-7845-24



Saug-Raspatorien, Saug-Dissektoren

Suction Raspatories, Suction Dissectors

3 mm
Saug-Dissektor
Suction dissector

mit Mandrel
with stylet

gebogen
curved

21,5 cm – 8½"

OZ-6429-02

NEGUS

3 mm
Saug-Rapatorium
Suction raspatory

mit Mandrel
with stylet

gebogen
curved

18,5 cm – 7¼"

OZ-6429-01

GORNEY

4 mm
Saug-Rapatorium
Suction raspatory

mit Mandrel
with stylet

scharf
sharp

20 cm – 8"

OZ-6429-30



Mikro-Saugkanülen Micro Suction Tubes

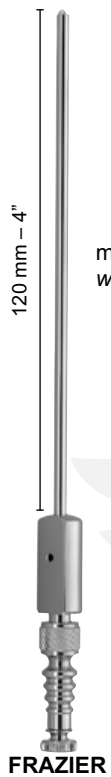

mit Mandrel
with stylet

Ø mm	Charr./Fr.	Arbeitslänge Working length
2,3	7	120 mm - 4"
3	9	OZ-6424-21
3,5	11	OZ-6424-22

FRAZIER



mit Mandrel
with stylet

Ø mm	Gauges	Arbeitslänge Working length
1,62	16	140 mm - 5 1/2"
1,22	18	OZ-6424-40
		OZ-6424-41

PRIBRAM

Katheterzangen Catheter Forceps



MAGILL



für Kleinkinder <i>for infants</i>	für Kinder <i>for children</i>	für Erwachsene <i>for adults</i>
15 cm – 6"	20 cm – 8"	25 cm – 10"
OZ-5295-15	OZ-5295-20	OZ-5295-25



Spritzen Syringes



Luer-Lock Ansatz
Luer Lock connector

mlcc	Dreiring-Spritze 3 ring syringe
2	OZ-5285-02
5	OZ-5285-05
10	OZ-5285-10

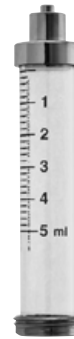

mlcc	Zylinder Cylinder
2	OZ-5285-52
5	OZ-5285-55
10	OZ-5285-60



JANET

mlcc	Spritze mit 2 Kanülen Syringe with 2 cannulas	Spritze, allein Syringe, only	Zylinder, allein Cylinder, only
50	OZ-5286-05	OZ-5286-55	OZ-5286-75
75	OZ-5286-07	OZ-5286-57	OZ-5286-77
100	OZ-5286-10	OZ-5286-60	OZ-5286-80
150	OZ-5286-15	OZ-5286-65	OZ-5286-85
200	OZ-5286-20	OZ-5286-70	OZ-5286-90



Luer-Lock Adapter

Luer-Lock Adapter



1:1

LLA weiblich
RC männlich
LLA female
RC male

OZ-5288-01



1:1

RC weiblich
LA männlich
RC female
LA male

OZ-5288-02



1:1

LLA weiblich
LLA female

OZ-5288-21



1:1

LLA männlich
LLA male

OZ-5288-03



1:1

LLA weiblich
LLA female

OZ-5288-04



1:1

LLA männlich
LLA male

OZ-5288-31

LA = Luer Konus Adapter
LLA = Luer-Lock Adapter
RC = Record Konus Adapter

LA = luer cone adapter
LLA = luer-lock adapter
RC = record conus adapter



Führungsnadeln Guiding Needles



Charr. /Fr.	Messerspitze, leicht gebogen <i>Knife tip, slightly curved</i>
8	OZ-5291-08
10	OZ-5291-10
12	OZ-5291-12
14	OZ-5291-14
16	OZ-5291-16
18	OZ-5291-18

REDON



Charr. /Fr.	Messerspitze, gebogen <i>Knife tip, curved</i>
8	OZ-5291-28
10	OZ-5291-30
12	OZ-5291-32
14	OZ-5291-34
16	OZ-5291-36
18	OZ-5291-38

REDON

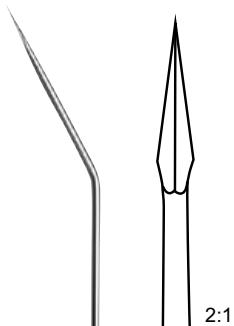

Charr. /Fr.	Lanzettenspitze, leicht gebogen <i>Lancet tip, slightly curved</i>
8	OZ-5291-48
10	OZ-5291-50
12	OZ-5291-52
14	OZ-5291-54
16	OZ-5291-56
18	OZ-5291-58

REDON



Sonden Probes

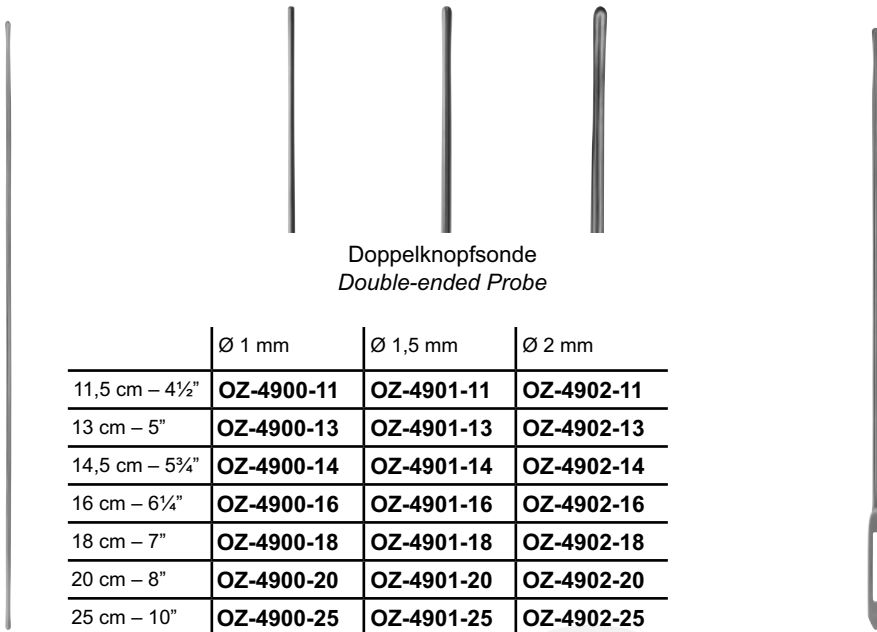

Doppelknopfsonde
Double-ended Probe

	Ø 1 mm	Ø 1,5 mm	Ø 2 mm
11,5 cm – 4½"	OZ-4900-11	OZ-4901-11	OZ-4902-11
13 cm – 5"	OZ-4900-13	OZ-4901-13	OZ-4902-13
14,5 cm – 5¾"	OZ-4900-14	OZ-4901-14	OZ-4902-14
16 cm – 6¼"	OZ-4900-16	OZ-4901-16	OZ-4902-16
18 cm – 7"	OZ-4900-18	OZ-4901-18	OZ-4902-18
20 cm – 8"	OZ-4900-20	OZ-4901-20	OZ-4902-20
25 cm – 10"	OZ-4900-25	OZ-4901-25	OZ-4902-25

	Öhrsonde Probe with eye
11,5 cm – 4½"	OZ-4906-11
13 cm – 5"	OZ-4906-13
14,5 cm – 5¾"	OZ-4906-14
16 cm – 6¼"	OZ-4906-16
18 cm – 7"	OZ-4906-18
20 cm – 8"	OZ-4906-20



WATSON-CHEYNE

	Sonde Probe
14 cm – 5½"	OZ-4907-13
18 cm – 7"	OZ-4907-18



FISH

	Sonde Probe
14,5 cm – 5¾"	OZ-4908-14
18 cm – 7"	OZ-4908-18



Sonden Probes



	Hohlsonde <i>Director</i>
11,5 cm – 4½"	OZ-4910-11
13 cm – 5"	OZ-4910-13
14,5 cm – 5¾"	OZ-4910-14
16 cm – 6¼"	OZ-4910-16
18 cm – 7"	OZ-4910-18
20 cm – 8"	OZ-4910-20



DOYEN



Sonde, gebogen
Probe, curved

14,5 cm – 5¾"

OZ-4911-14



	Hohlsonde <i>Director</i>
13 cm – 5"	OZ-4912-13
14,5 cm – 5¾"	OZ-4912-14
16 cm – 6¼"	OZ-4912-16
18 cm – 7"	OZ-4912-18



Sonde
Probe

14,5 cm – 5¾"

OZ-4913-14



Myrtenblattsonde
Myrtle leaf probe

13 cm – 5"

OZ-4914-13

14,5 cm – 5¾"

OZ-4914-14

16 cm – 6¼"

OZ-4914-16

20 cm – 8"

OZ-4914-20

Sonden Probes

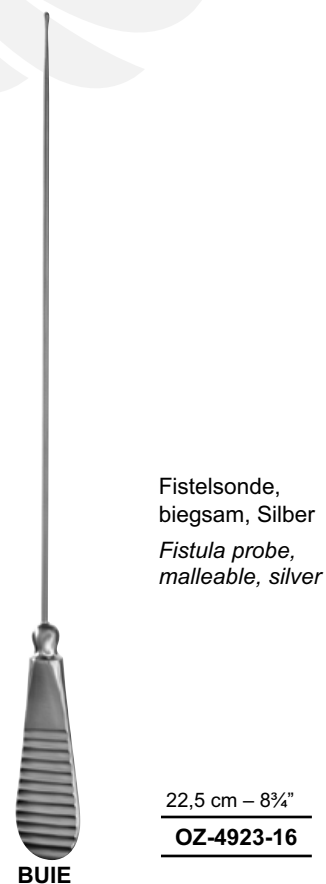
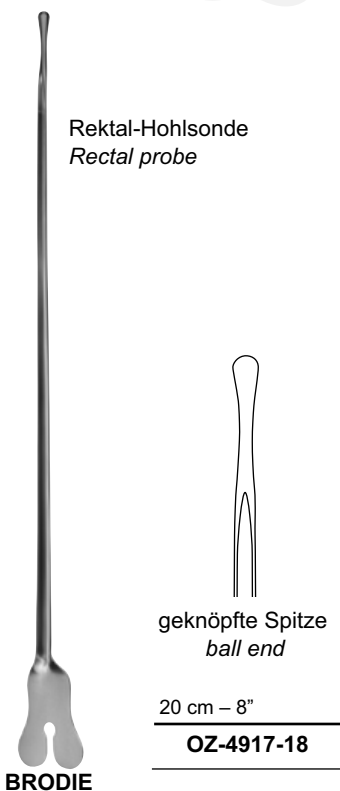
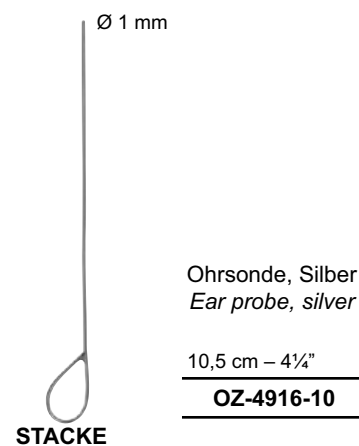
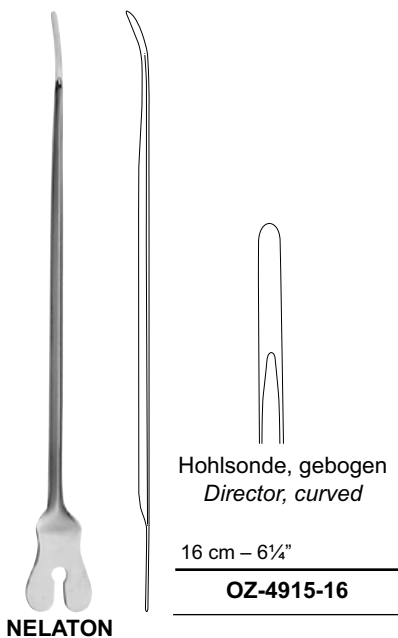



Sonden Probes

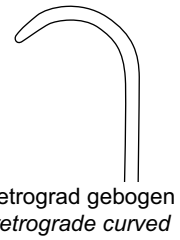
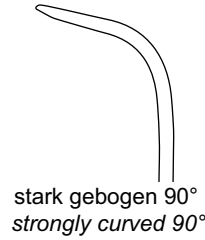
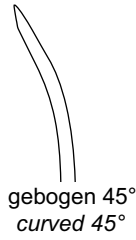
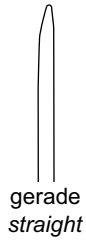

17 cm – 6¾"

Fig. 1	Fig. 2	Fig. 3	Fig. 4
OZ-4925-01	OZ-4925-02	OZ-4925-03	OZ-4925-04

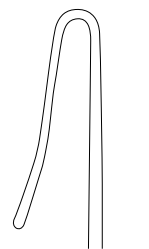
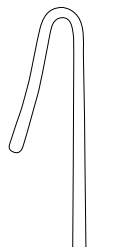
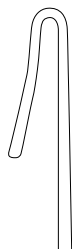
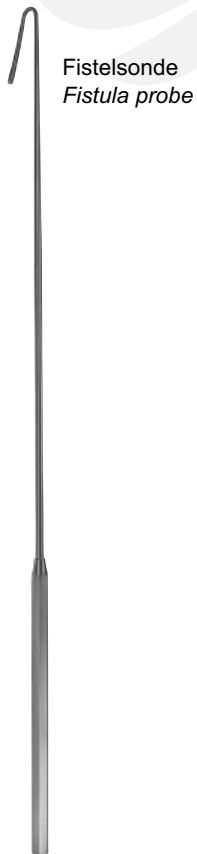

21 cm – 8¼"

OZ-4926-01	OZ-4926-02	OZ-4926-03
------------	------------	------------



Watteträger Cotton Applicators

spiralförmig gerieft
spiral threads

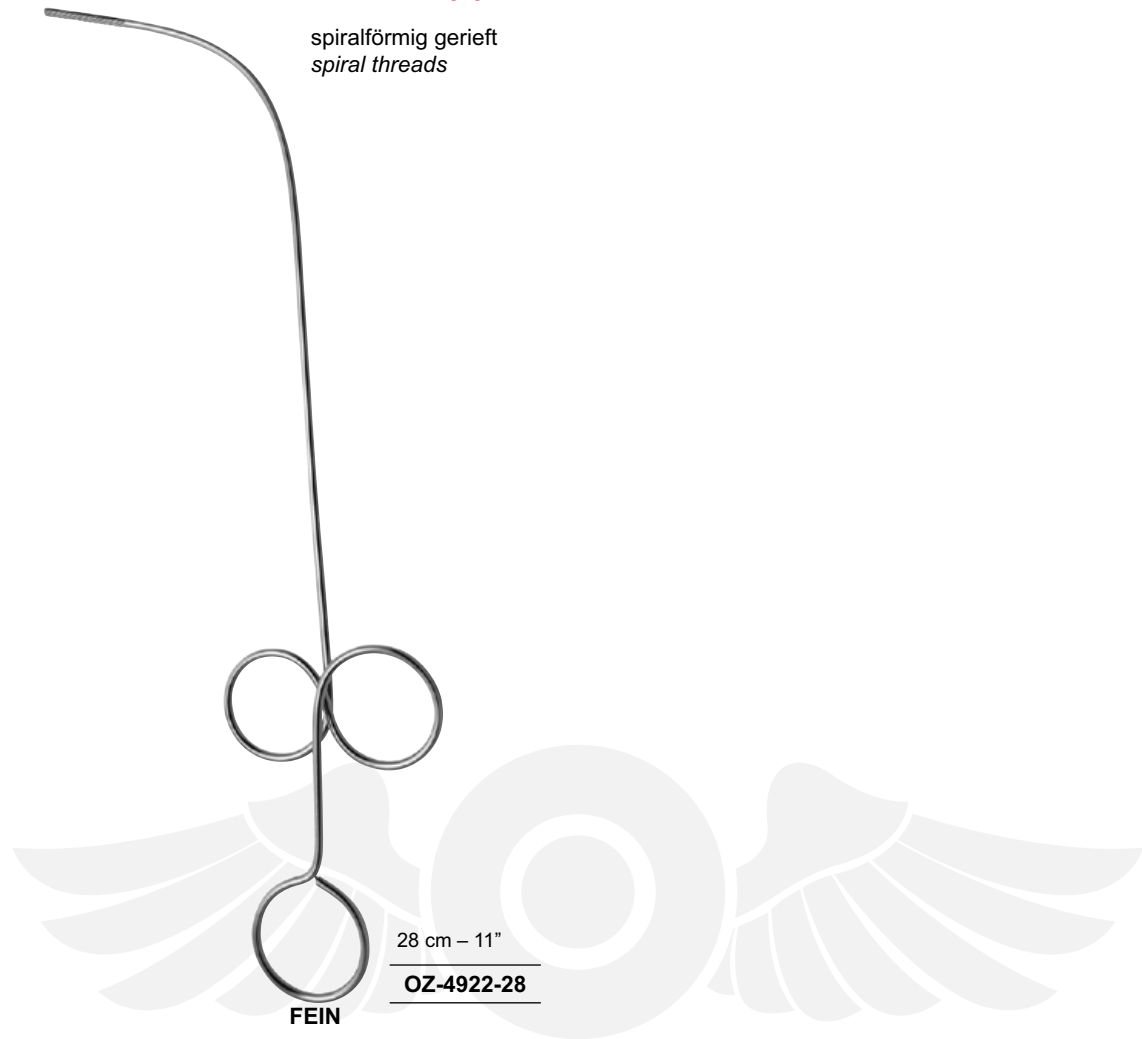

28 cm – 11"

OZ-4922-28

FEIN

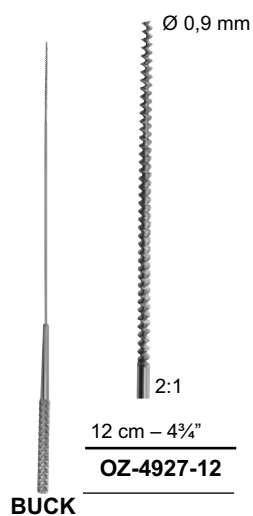

Ø 0,9 mm

2:1

12 cm – 4¾"

OZ-4927-12

BUCK

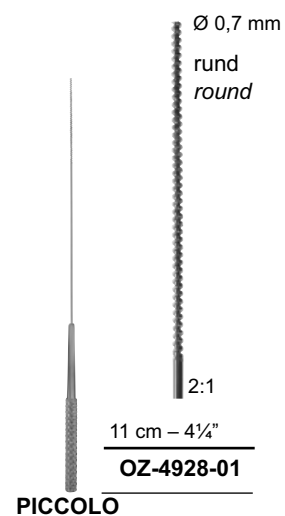

Ø 0,7 mm

rund
round

2:1

11 cm – 4¼"

OZ-4928-01

PICCOLO



OZZE MEDICAL & SURGICAL SUPPLIES
TOOLS TO OPERATE

Watteträger Cotton Applicators

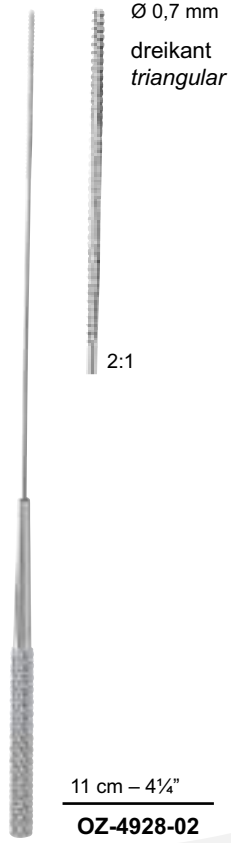

PICCOLO

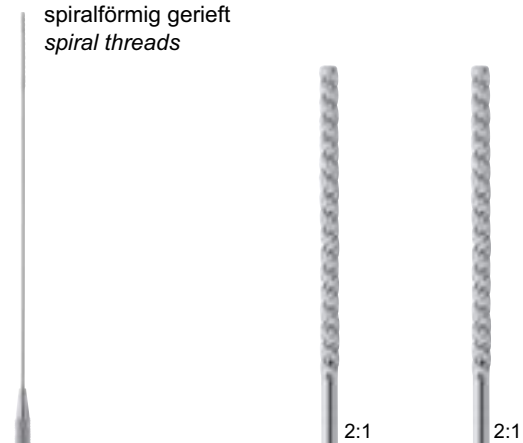

UNIVERSAL

	Ø 1,3 mm	Ø 1,4 mm
12,5 cm – 5"	OZ-4930-12	–
16 cm – 6¼"	OZ-4930-16	–
18 cm – 7"	–	OZ-4931-18

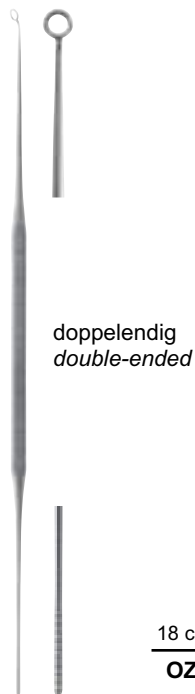

JOBSON-HORNE



Watteträger Cotton Applicators



FARRELL

	Ø mm mm	rund gerieft serrated round	dreikant gerieft triangular serrated
14 cm – 5½"	0,9	OZ-4935-14	OZ-4936-14
16,5 cm – 6½"	1,1	OZ-4935-16	OZ-4936-16



FROHN

	Ø mm mm	spiralför migs spiral threads
12 cm – 4¾"	1 mm	OZ-4934-01
14 cm – 5½"	1 mm	OZ-4934-02
16 cm – 6¼"	1 mm	OZ-4934-03

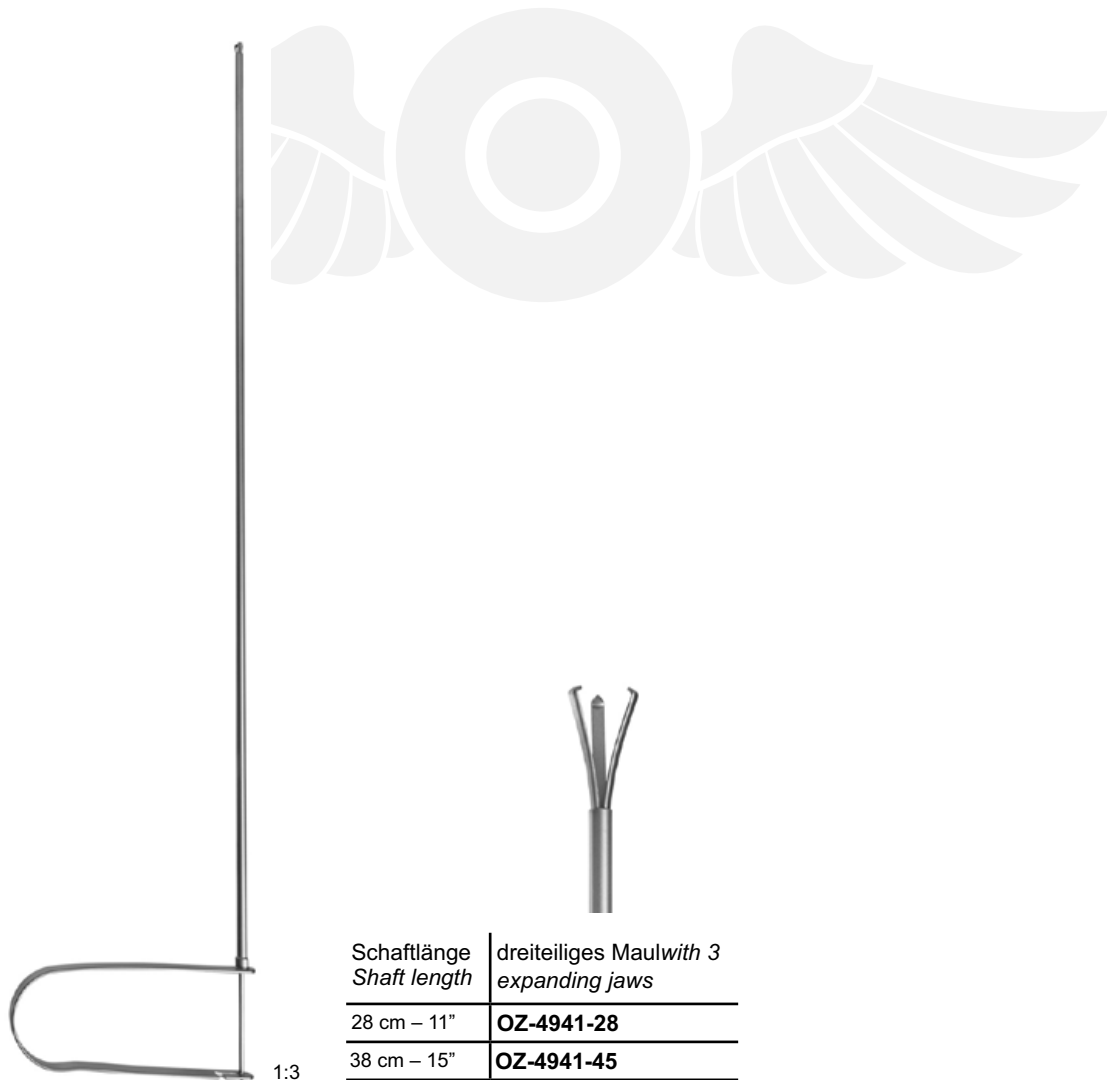

Schaftlänge Shaft length	dreiteiliges Maul with 3 expanding jaws
28 cm – 11"	OZ-4941-28
38 cm – 15"	OZ-4941-45

1:3



©ZZE MEDICAL & SURGICAL SUPPLIES

TOOLS TO OPERATE



SEVEN

🖱 www.ozzesurgical.com.au

✉ info@ozzesurgical.com.au

Wundverschluß

Woundclosure

Nadelhalter-Profil	<i>Needle Holder Tread</i>	WO 1 - 2
Mikro-Nadelhalter	<i>Micro Needle Holders</i>	WO 3 - 9
Nadelhalter	<i>Needle Holders</i>	WO 10 - 37
Unterbindungsnadeln	<i>Ligature Needles</i>	WO 38 - 43
Reverdinnadeln	<i>Reverdin Needles</i>	WO 44 - 45
Führungs-Hohlsonden	<i>Guiding Probes</i>	WO 46 - 50
Wundklammern	<i>Suture Clips</i>	WO 51
Klammeranlegepinzetten	<i>Clip Applying Forceps</i>	WO 52
Chirurgisches Taschenbesteck	<i>Pocket Instrument Set</i>	WO 53
Venae Sectio Besteck	<i>Venae Secito Set</i>	WO 54
Gipsverband- Instrumente	<i>Plaster Cast Instruments</i>	WO 55 - 58



Nadelhalter-Profil Needle Holder Tread

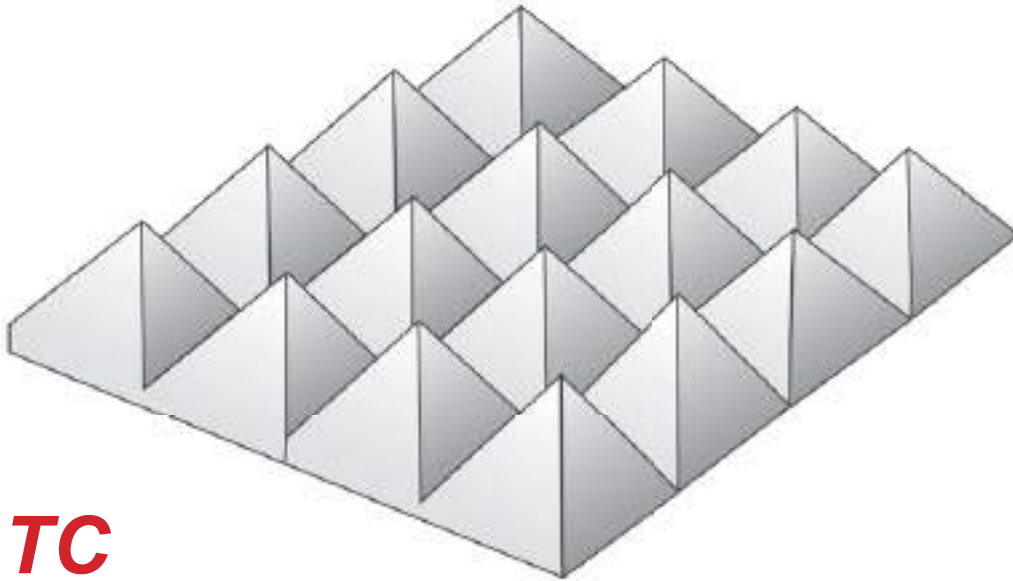

TC

OZZE Medical TC Nadelhalter mit diamant-geschliffenem Profil

Für die OZZE Medical Nadelhalter werden nur Nadelhalterplatten mit diamant-geschliffenem Pyramidenprofil verwendet.

OZZE Medical TC Nadelhalter entsprechen höchsten Ansprüchen:

präzise Ausführung und hervorragende Qualität
optimale Abstimmung des Nadelhalters und der

TC-Einlage auf den Verwendungszweck
grazile Nadelhalter für feinste Arbeiten,
stabile Nadelhalter für größere Nadeln.

sichere und präzise Sperre, abgestimmt auf die
Gesamtstärke des Nadelhalters.

Nur ein diamant-geschliffenes Nadelhalterprofil
garantiert:

die hohe Präzision der eingeschliffenen Pyramidenstruktur

das homogene, tiefgeschliffene Profil der TC-Platten

den sicheren Halt der Nadel oder des Nahtmaterials.

hohe Profil-Formbeständigkeit, Härte und Verschleißfestigkeit.

OZZE Medical TC Needle Holders with diamond-cut tread

For the TC needle holders OZZE Medical uses only diamond-cut TC inserts with pyramidal tread.

OZZE Medical TC Needle Holders meet the highest requirements:

*precise design and excellent quality
optimal matching of the needle holder and the TC inserts to the application purpose
slim needle holders for delicate applications,
solid needle holders for larger needles
firm and precise ratchet corresponding to the design of the needle holder.*

*Only a diamond-cut needle holder tread guarantees:
a high precision of the pyramidal structure of the tread*

homogeneous and deep tread of the TC inserts

firm holding of the needle or of the suturing material

high deformation resistance, hardness and wear resistance even of the most delicate tread.



Nadelhalter-Profil Needle Holder Tread

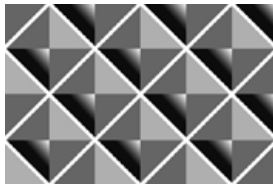

0,5 mm
für Nadeln und Nahtmaterial
bis Stärke 3/0

2500 tpsi (teeth per square inch)
for needles and suturing material
with a thickness of up to 3/0

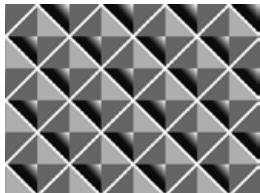

0,4 mm
für feine Nadeln und Nahtmaterial,
Stärke 4/0 – 6/0

3600 tpsi (teeth per square inch) for delicate
needles and suturing material with a thick-
ness of up to 4/0 - 6/0

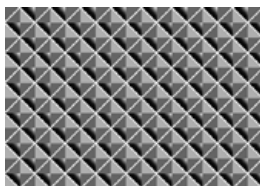

0,3 mm
für feine Nadeln und Nahtmaterial
bis Stärke 8/0

7000 tpsi (teeth per square inch) for
delicate needles and suturing material
with a thickness of up to 8/0

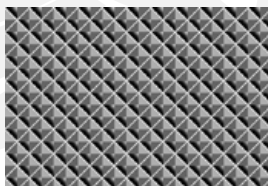

0,2 mm
für feinste Nadeln und Nahtmaterial,
Stärke 6/0 – 10/0

14400 tpsi (teeth per square inch)
for delicate needles and suturing
material, thickness 6/0 – 10/0



MICROGRIP
für extrem feines Nahtmaterial,
Stärke 6/0 – 11/0

for extremely delicate suturing material,
thickness 6/0 – 11/0



Glatt,
für extrem feines Nahtmaterial,
Stärke 6/0 – 11/0

Smooth,
for extremely delicate suturing material,
thickness 6/0 – 11/0



Mikro-Nadelhalter Micro Needle Holders

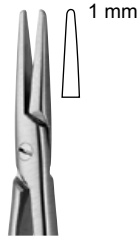
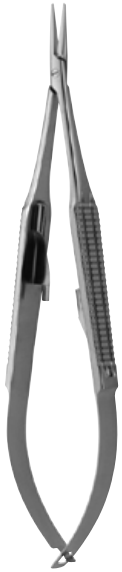

gerade
straight

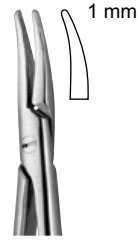

gebogen
curved

	mit Sperre <i>with ratchet</i>	ohne Sperre- <i>without ratchet</i>	mit Sperre <i>with ratchet</i>	ohne Sperre- <i>without ratchet</i>
15 cm – 6"	OZ-5852-15	OZ-5850-15	OZ-5853-15	OZ-5851-15

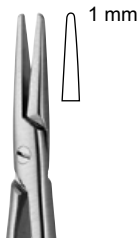

gerade
straight

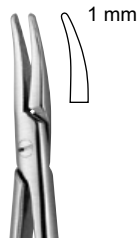

gebogen
curved

	mit Sperre <i>with ratchet</i>	ohne Sperre- <i>without ratchet</i>	mit Sperre <i>with ratchet</i>	ohne Sperre- <i>without ratchet</i>
18 cm – 7"	OZ-5852-18	OZ-5850-18	OZ-5853-18	OZ-5851-18



Mikro-Nadelhalter Micro Needle Holders



JACOBSON

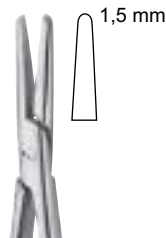

gerade
straight

	mit Sperre with ratchet	ohne Sperre without ratchet
18 cm – 7"	OZ-5854-36	OZ-5854-39
21 cm – 8¼"	OZ-5854-46	OZ-5854-49



JACOBSON

Körnung 0,4 mm
Grit 3600 tpsi

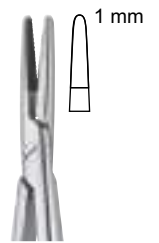

gerade
straight

	Typ Type	mit Sperre with ratchet
18 cm – 7"	TC	OZ-5930-32
20 cm – 8"	TC	OZ-5930-42
22,5 cm – 8¾"	TC	OZ-5930-52

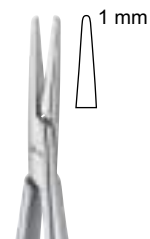

gerade
straight



gebogen
curved

	mit Sperre with ratchet	ohne Sperre without ratchet	mit Sperre with ratchet	ohne Sperre without ratchet
12 cm – 4¾"	OZ-5864-12	OZ-5860-12	OZ-5865-12	OZ-5861-12
14,5 cm – 5¾"	OZ-5864-15	OZ-5860-15	OZ-5865-15	OZ-5861-15
18 cm – 7"	OZ-5864-18	OZ-5860-18	OZ-5865-18	OZ-5861-18
21 cm – 8¼"	OZ-5864-21	OZ-5860-21	OZ-5865-21	OZ-5861-21
23 cm – 9"	OZ-5864-23	OZ-5860-23	OZ-5865-23	OZ-5861-23

Mikro-Nadelhalter Micro Needle Holders

Evolution / Nano

leichter als Titan dank neuem Griff-Design
alle Vorzüge von Edelstahlinstrumenten
außergewöhnlich gute Haptik für präzises Arbeiten
problemloses Reinigen für bestmögliche Hygiene
optimale Ergonomie dank der runden Griffschalen

Evolution / Nano

*lighter than titanium thanks to the new handle design
all advantages of stainless steel instruments
unsurpassed haptics for precision during the operation
easy cleaning for best possible hygiene
optimal ergonomomy due to the round shell handles*

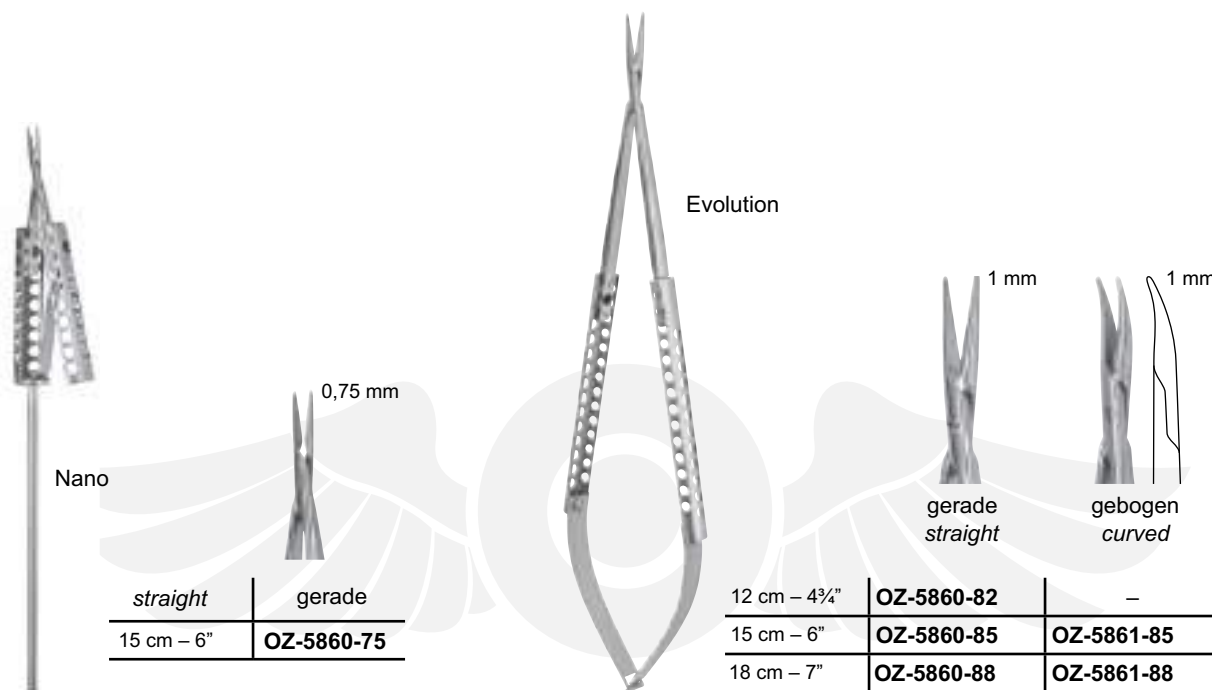

Nano

0,75 mm

straight | gerade

15 cm – 6"	OZ-5860-75
------------	-------------------

Evolution

1 mm | 1 mm

gerade straight | gebogen curved

12 cm – 4¾"	OZ-5860-82	–
15 cm – 6"	OZ-5860-85	OZ-5861-85
18 cm – 7"	OZ-5860-88	OZ-5861-88

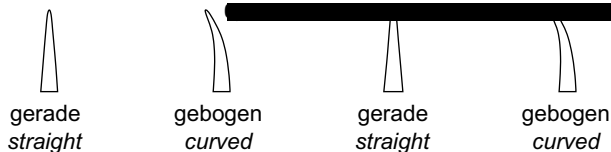

	Typ Type	ohne Sperre without ratchet		ohne Sperre without ratchet	
14,5 cm – 5¾"	TI	OZ-5862-14T	OZ-5862-15T	OZ-5862-18T	OZ-5862-19T
18 cm – 7"	TI	OZ-5862-34T	OZ-5862-35T	OZ-5862-38T	OZ-5862-39T
21 cm – 8¼"	TI	OZ-5862-44T	OZ-5862-45T	OZ-5862-48T	OZ-5862-49T



Mikro-Nadelhalter Micro Needle Holders



Körnung 0,3 mm
Grit 7000 tpsi

CASTROVIEJO

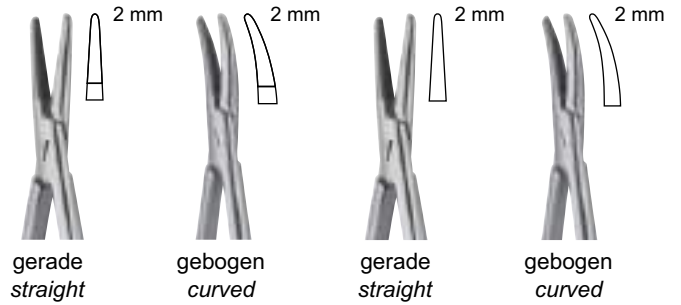

Typ Type	mit Sperre with ratchet	mit Sperre with ratchet		mit Sperre with ratchet	
		Körnung Grit	Körnung Grit	glatt smooth	glatt smooth
14 cm – 5½"	TC	OZ-5931-12	OZ-5931-13	OZ-5931-16	OZ-5931-17
18 cm – 7"	TC	OZ-5931-32	OZ-5931-33	OZ-5931-36	OZ-5931-37
21 cm – 8¼"	TC	OZ-5931-42	OZ-5931-43	OZ-5931-46	OZ-5931-47



Körnung 0,2 mm
Grit 14400 tpsi

CASTROVIEJO/BARRAQUER

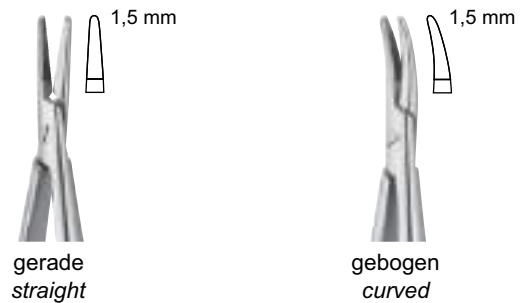

	Typ Type	mit Sperre with ratchet	ohne Sperre without ratchet	mit Sperre with ratchet	ohne Sperre without ratchet
14,5 cm – 5¾"	TC	OZ-5866-12	OZ-5866-14	OZ-5866-13	OZ-5866-15
18 cm – 7"	TC	OZ-5866-32	OZ-5866-34	OZ-5866-33	OZ-5866-35
21 cm – 8¼"	TC	OZ-5866-42	OZ-5866-44	OZ-5866-43	OZ-5866-45
23 cm – 9"	TC	OZ-5866-52	OZ-5866-54	OZ-5866-53	OZ-5866-55



Mikro-Nadelhalter Micro Needle Holders



CASTROVIEJO



gerade
straight

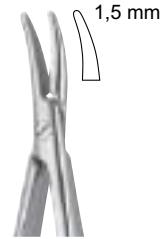

gebogen
curved

	mit Sperre <i>with ratchet</i>	ohne Sperre <i>without ratchet</i>	mit Sperre <i>with ratchet</i>	ohne Sperre <i>without ratchet</i>
14 cm – 5½"	OZ-5952-14	OZ-5950-14	OZ-5953-14	OZ-5951-14



CASTROVIEJO

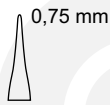

gerade
straight

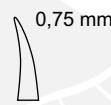

gebogen
curved

	mit Sperre <i>with ratchet</i>	ohne Sperre <i>without ratchet</i>	mit Sperre <i>with ratchet</i>	ohne Sperre <i>without ratchet</i>
9 cm – 3½"	OZ-5958-09	OZ-5956-09	OZ-5959-09	OZ-5957-09

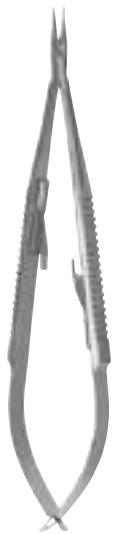

CASTROVIEJO

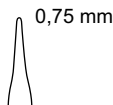

gerade
straight



gebogen
curved

	mit Sperre <i>with ratchet</i>	ohne Sperre <i>without ratchet</i>	mit Sperre <i>with ratchet</i>	ohne Sperre <i>without ratchet</i>
14 cm – 5½"	OZ-5958-14	OZ-5956-14	OZ-5959-14	OZ-5957-14



Mikro-Nadelhalter Micro Needle Holders



BARRAQUER-TROUTMAN

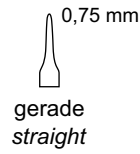

	mit Sperre with ratchet	ohne Sperre without ratchet	mit Sperre with ratchet	ohne Sperre without ratchet
10 cm – 4"	OZ-5976-10	OZ-5974-10	OZ-5977-10	OZ-5975-10



BARRAQUER

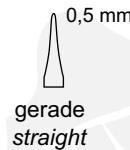

	Typ Type	mit Sperre with ratchet	ohne Sperre without ratchet	
11,5 cm – 4½"		OZ-5973-17	OZ-5970-11	OZ-5971-11
	TI	OZ-5973-17T	–	OZ-5971-11T



BARRAQUER

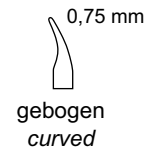
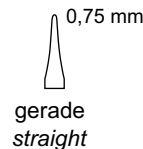
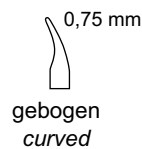

	Typ Type	mit Sperre with ratchet	ohne Sperre without ratchet	
12 cm – 4¾"		OZ-5973-12	OZ-5970-12	OZ-5971-12
	TI	OZ-5973-12T	–	OZ-5971-12T



OZZE MEDICAL & SURGICAL SUPPLIES
TOOLS TO OPERATE

Mikro-Nadelhalter Micro Needle Holders

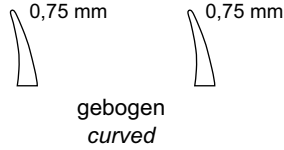

	mit Sperre <i>with ratchet</i>	ohne Sperre <i>without ratchet</i>
13 cm – 5"	OZ-5970-02	OZ-5970-01

BARRAQUER



	ohne Sperre <i>without ratchet</i>	mit Sperre <i>with ratchet</i>
14 cm – 5½"	OZ-5971-14	OZ-5973-14

BARRAQUER

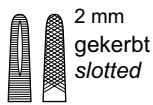

gerade,
mit Sperre
straight, with ratchet

14 cm – 5½"
OZ-5986-14

KALT



gerade,
mit Sperre
straight, with ratchet

13,5 cm – 5¼"
OZ-5987-14

CASTROVIEJO-KALT

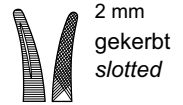

gebogen,
mit Sperre
curved, with ratchet

14 cm – 5½"
OZ-5988-14



KALT-ARRUGA



Nadelhalter Needle Holders

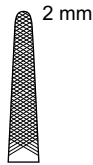

HALSEY

	2 mm		2 mm
kreuzgerieft cross serrated		glatt smooth	
13 cm – 5"			
OZ-5918-13		OZ-5918-18	

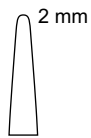

WEBSTER

	2 mm
glatt smooth	
13 cm – 5"	
OZ-5920-13	



DERF

	2,5 mm
gekerbt slotted	
12 cm – 4¾"	
OZ-5922-12	

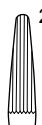

DERF

	2 mm
längsgerieft lengthways serrated	
12,5 cm – 5"	
OZ-5924-12	



HEGAR-BAUMGARTNER

	2,5 mm
kreuzgerieft cross serrated	
14 cm – 5½"	
OZ-5927-14	



BROWN

	2,5 mm
Maul fein gerieft, Maulteile con- vexfine serrated jaws,convex jaws	
13 cm – 5"	
OZ-5928-13	
18 cm – 7"	
OZ-5928-18	

Nadelhalter Needle Holders



NEW ORLEANS

3 mm
 gekerbt
 slotted
 18 cm – 7"
OZ-5929-18



MAYO-HEGAR

<i>straight</i>	<i>gerade</i>
14 cm – 5½"	OZ-6000-14
16 cm – 6¼"	OZ-6000-16
18 cm – 7"	OZ-6000-18
20 cm – 8"	OZ-6000-20
24 cm – 9½"	OZ-6000-24
26 cm – 10¼"	OZ-6000-26
30 cm – 11¾"	OZ-6000-30

-	<i>gebogen curved</i>
16 cm – 6¼"	OZ-6001-16

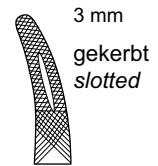
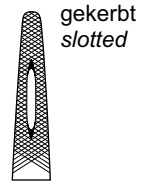

HEANEY

3 mm
 gebogen
 curved
 21 cm – 8¼"
OZ-6002-21

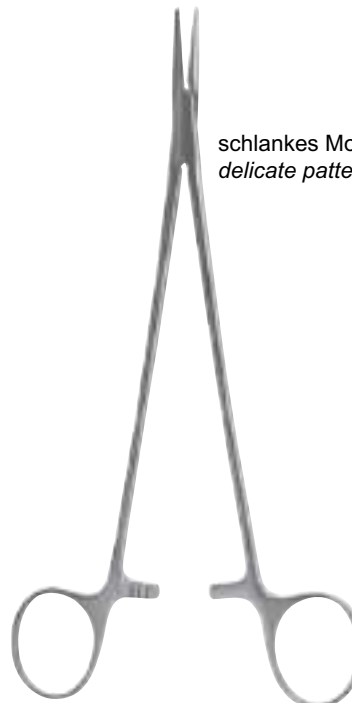

MAYO-HEGAR

schlankes Modell
delicate pattern

-	<i>gekerbt/slotted</i>
16 cm – 6¼"	OZ-6003-16
18 cm – 7"	OZ-6003-18
20 cm – 8"	OZ-6003-20

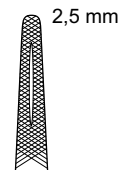



Nadelhalter Needle Holders



kräftiges Modell
heavy pattern

HEGAR



gekerbt
slotted



kreuzgerieft
cross serrated

16 cm – 6¼"	OZ-6004-16	–
18 cm – 7"	OZ-6004-18	–
20 cm – 8"	OZ-6004-20	OZ-6004-21



gekerbt
slotted

17 cm – 6¾"	OZ-6005-17
-------------	-------------------

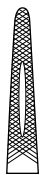

gekerbt/slotted

18,5 cm – 7¼"	OZ-6006-18
26 cm – 10¼"	OZ-6006-26



OZZE MEDICAL & SURGICAL SUPPLIES
TOOLS TO OPERATE

Nadelhalter Needle Holders

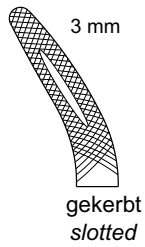

27 cm – 10½"
OZ-6007-27

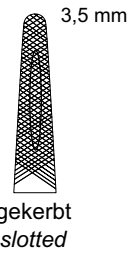
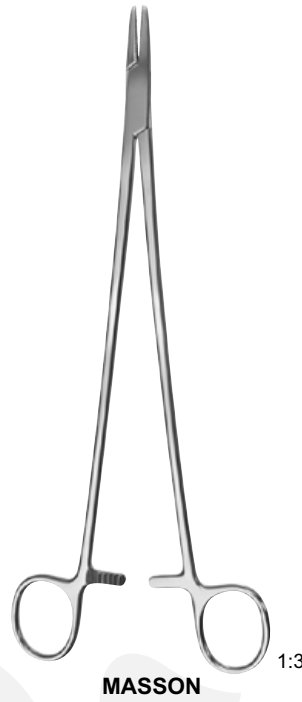

26,5 cm – 10½"
OZ-6008-27

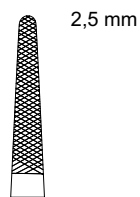
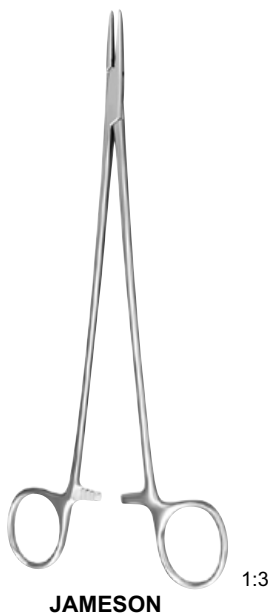

23,5 cm – 9¼"
OZ-6009-23

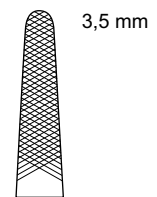

27 cm – 10½"
OZ-6010-27



Nadelhalter Needle Holders



CRILE-WOOD

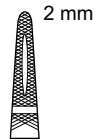

2 mm
gekerbt
slotted

15 cm – 6"

OZ-6012-15



CRILE-MURRAY

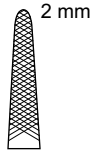

2 mm
15 cm – 6"

OZ-6014-15



ADSON

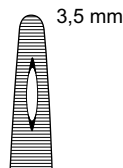

3,5 mm
gefenstert
fenestrated

18 cm – 7"

OZ-6016-18



SENNING



2,5 mm
gekerbt
slotted

17 cm – 6¾"

OZ-6017-17



OZZE MEDICAL & SURGICAL SUPPLIES
TOOLS TO OPERATE

Nadelhalter Needle Holders



BABY-OLSEN-HEGAR

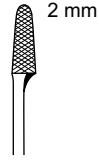

kreuzgerieft
cross serrated

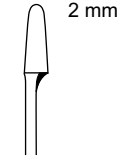

glatt
smooth

11 cm – 4¼"

OZ-6029-11	OZ-6029-31
------------	------------



BABY-OLSEN-HEGAR



Körnung 0,4 mm
Grit 3600 tpsi



glatt
smooth

11,5 cm – 4½"

Typ / Type	11,5 cm – 4½"	
TC	OZ-6079-11	OZ-6079-31



OLSEN-HEGAR

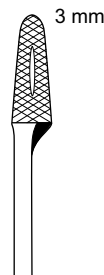

gekerbtslotted

14 cm – 5½"	OZ-6030-14
18 cm – 7"	OZ-6030-18



Nadelhalter Needle Holders



OLSEN-HEGAR



kreuzgerieft
cross serrated

17 cm – 6¾"

OZ-6030-17



OLSEN-HEGAR

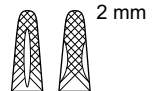

gerade, gekerbt
straight, slotted

14 cm – 5½"

OZ-6031-14



OLSEN-HEGAR

Körnung 0,5 mm
Grit 2500 tpsi

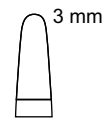
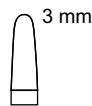

Typ / Type	14 cm – 5½"	17 cm – 6¾"	18,5 cm – 7¼"
TC	OZ-6080-14	OZ-6080-17	OZ-6080-18



OZZE MEDICAL & SURGICAL SUPPLIES
TOOLS TO OPERATE

Nadelhalter Needle Holders



GILLIES

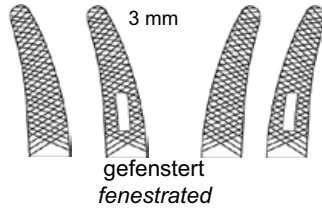
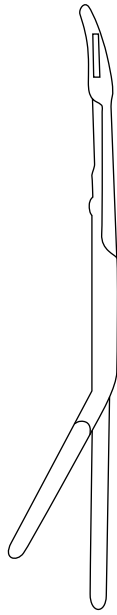

16 cm – 6¼"

OZ-6032-16

OZ-6032-16L



GILLIES

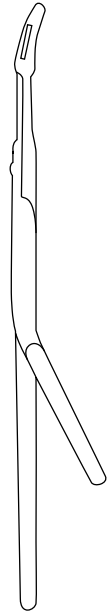

3 mm
Linkshänder
Left-handed



GILLIES SLIM



gefenstert
fenestrated

15 cm – 6"

OZ-6033-14

OZ-6033-14L



Nadelhalter Needle Holders

Körnung 0,4 mm
Grit 3600 tpsi

2 mm

2 mm
Linkshänder
Left-handed

Typ / Type	15,5 cm – 6"	
TC	OZ-6081-14	OZ-6081-14L

GILLIES SLIM

Körnung 0,5 mm
Grit 2500 tpsi

2,5 mm

2,5 mm
Linkshänder
Left-handed

Typ / Type	16 cm – 6¼"	
TC	OZ-6081-16	OZ-6081-16L

GILLIES

Nadelhalter Needle Holders

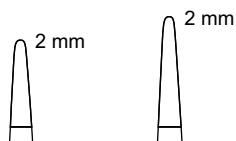
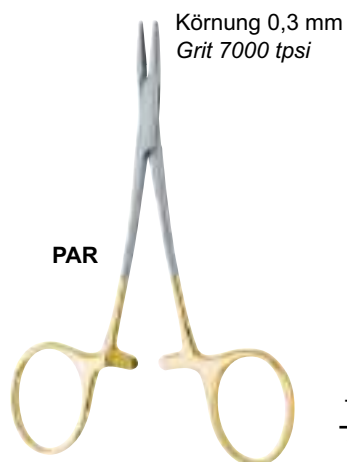

Typ / Type	11,5 cm – 4½"	13,5 cm – 5¼"
TC	OZ-6044-01	OZ-6044-03

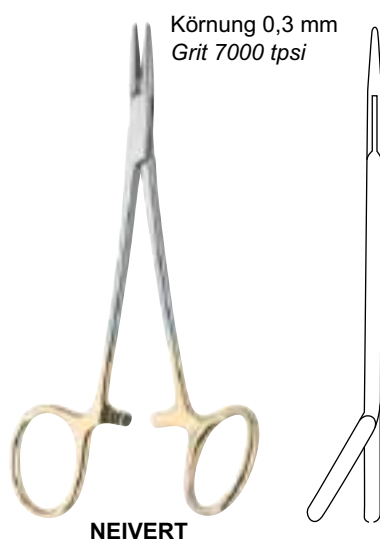

Typ / Type	13 cm – 5"	
TC	OZ-6044-13	OZ-6044-13L

Nadelhalter Needle Holders

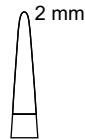

Typ / Type	13 cm – 5"
TC	OZ-6045-13

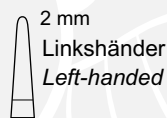
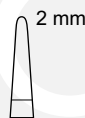

glatt
smooth

Typ / Type	13 cm – 5"	
TC	OZ-6046-13	OZ-6046-13L

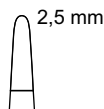

Typ / Type	12,5 cm – 5"
TC	OZ-6047-12



OZZE MEDICAL & SURGICAL SUPPLIES
TOOLS TO OPERATE

Nadelhalter Needle Holders



Körnung 0,4 mm
Grit 3600 tpsi

NEW ORLEANS

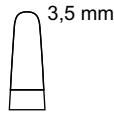

Typ / Type	18 cm – 7"
TC	OZ-6048-18

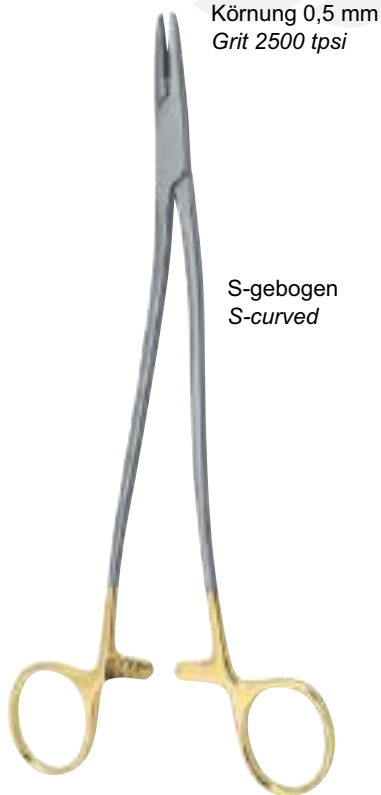

Körnung 0,5 mm
Grit 2500 tpsi

S-gebogen
S-curved

BOZEMANN

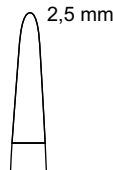

Typ / Type		
TC	20 cm – 8"	OZ-6049-20
TC	24 cm – 9½"	OZ-6049-24
TC	26 cm – 10¼"	OZ-6049-26



Nadelhalter Needle Holders

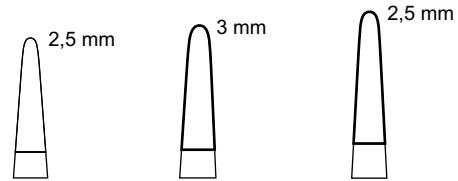

Typ / Type	16 cm – 6¼"	18 cm – 7"	20 cm – 8"
TC	OZ-6050-16	OZ-6050-18	OZ-6050-20

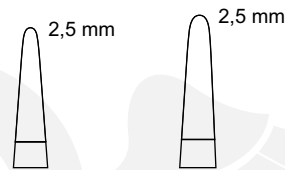

Linkshänder
Left-handed

Linkshänder
Left-handed

Typ / Type	16 cm – 6¼"	18 cm – 7"
TC	OZ-6050-16L	OZ-6050-18L

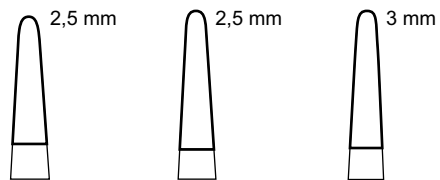

Typ / Type	24 cm – 9½"	26 cm – 10¼"	30 cm – 11¾"
TC	OZ-6050-24	OZ-6050-26	OZ-6050-30



OZZE MEDICAL & SURGICAL SUPPLIES
TOOLS TO OPERATE

Nadelhalter Needle Holders

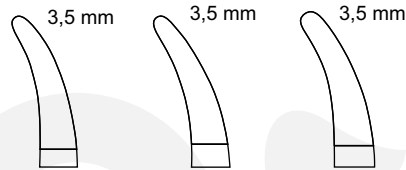

Typ / Type	20 cm – 8"	24 cm – 9½"	26 cm – 10¼"
TC	OZ-6051-20	OZ-6051-24	OZ-6051-26

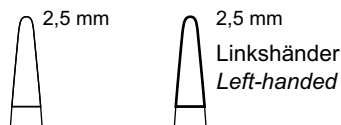

Typ / Type	14 cm – 5½"	
TC	OZ-6052-14	OZ-6052-14L

Nadelhalter Needle Holders

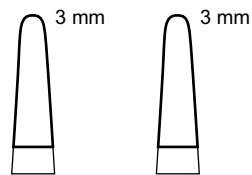

Typ / Type	20 cm – 8"	24 cm – 9½"
TC	OZ-6053-20	OZ-6053-24

Nadelhalter Needle Holders

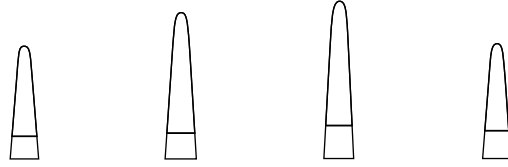

Typ / Type	16 cm – 6¼"	18 cm – 7"	20 cm – 8"	21 cm – 8¼"
TC	OZ-6054-40	OZ-6054-18	OZ-6054-20	OZ-6054-41

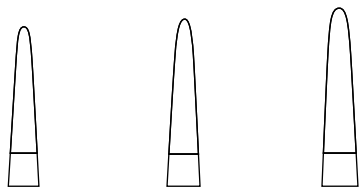

Typ / Type	23 cm – 9"	26,5 cm – 10½"	30,5 cm – 12"
TC	OZ-6054-23	OZ-6054-26	OZ-6054-31

DE BAKEY

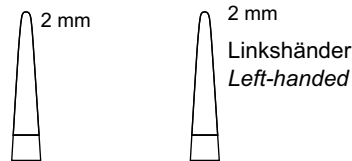

Typ / Type	18 cm – 7"	
TC	OZ-6054-68	OZ-6054-68L

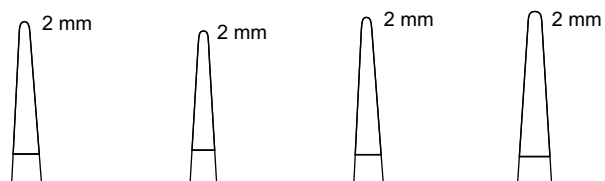

Typ / Type	20 cm – 8"	23 cm – 9"	26,5 cm – 10½"	30,5 cm – 12"
TC	OZ-6054-70	OZ-6054-73	OZ-6054-76	OZ-6054-81



Nadelhalter Needle Holders

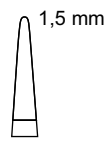

15 cm – 6"

OZ-6055-01

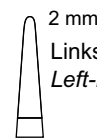
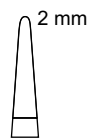

2 mm
Linkshänder
Left-handed

Typ / Type	15 cm – 6"	
TC	OZ-6055-15	OZ-6055-15L

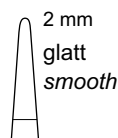

Typ / Type	15 cm – 6"
TC	OZ-6055-35



Nadelhalter Needle Holders



Körnung 0,4 mm
Grit 3600 tpsi

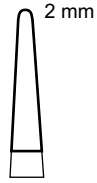

2 mm
Linkshänder
Left-handed

Typ / Type	18 cm – 7"	
TC	OZ-6055-18	OZ-6055-18L

CRILE-WOOD

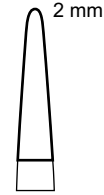
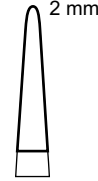
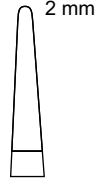
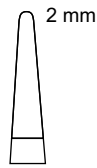

Typ / Type	20 cm – 8"	23 cm – 9"	26 cm – 10¼"	31 cm – 12¼"
TC	OZ-6055-20	OZ-6055-23	OZ-6055-26	OZ-6055-31



Körnung 0,3 mm
Grit 7000 tpsi

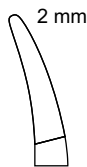

Typ / Type	18 cm – 7"
TC	OZ-6055-48

CRILE-WOOD



Körnung 0,3 mm
Grit 7000 tpsi



Typ / Type	20 cm – 8"
TC	OZ-6055-50

JULIAN



Nadelhalter Needle Holders

Körnung 0,4 mm
Grit 3600 tpsi



CRILE-WOOD



Typ / Type	23 cm – 9"
TC	OZ-6055-53

Körnung 0,4 mm
Grit 3600 tpsi



HALSEY

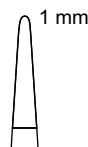

Typ / Type	13 cm – 5"
TC	OZ-6056-13
TI	OZ-6056-13T

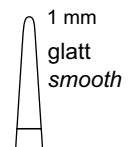

Typ / Type	13 cm – 5"
TC	OZ-6056-33



Nadelhalter Needle Holders



CONVERSE

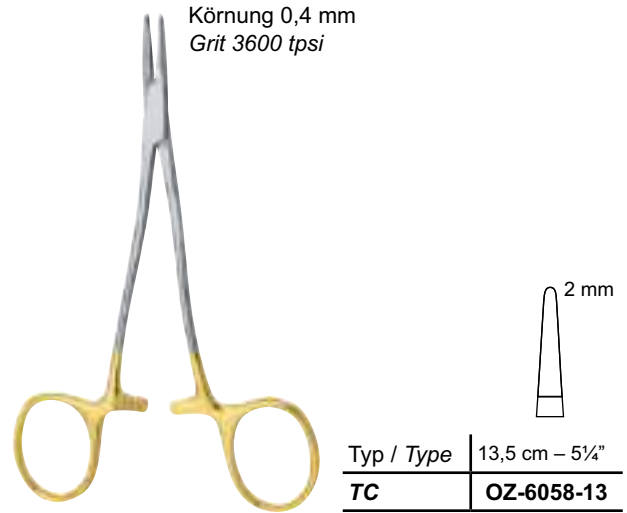

KILNER



HEGAR-VASCULAR



Nadelhalter Needle Holders



MICROVASCULAR

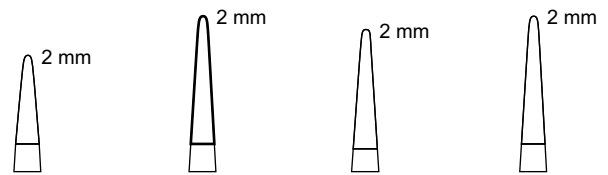

Typ / Type	14 cm – 5½"	18 cm – 7"	20 cm – 8"	22 cm – 8¾"
TC	OZ-6059-29	OZ-6059-30	OZ-6059-31	OZ-6059-32

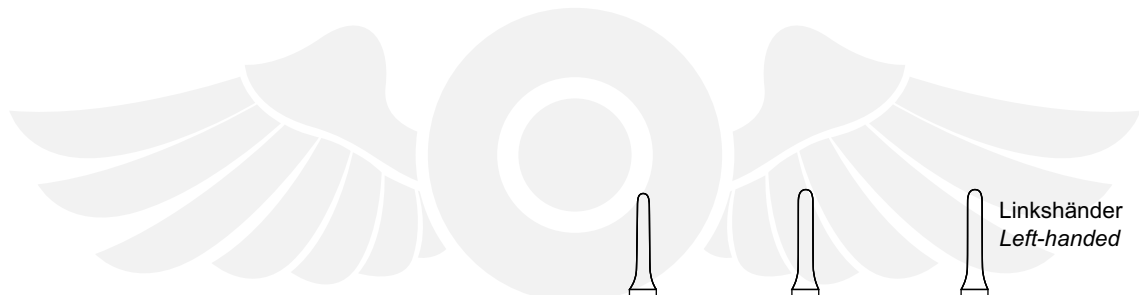

Typ / Type	13 cm – 5"	15 cm – 6"	
TC	OZ-6059-13	OZ-6059-16	OZ-6059-16L



RYDER

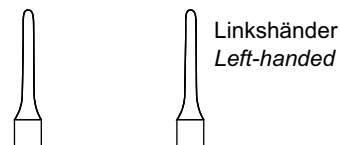

Typ / Type	18 cm – 7"	
TC	OZ-6059-18	OZ-6059-18L

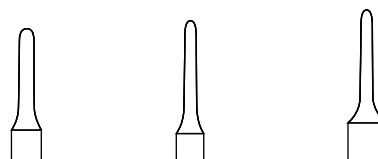

Typ / Type	20 cm – 8"	23 cm – 9"	25 cm – 10"
TC	OZ-6059-20	OZ-6059-23	OZ-6059-26



Nadelhalter Needle Holders



Körnung 0,2 mm
Grit 14400 tpsi

MICRO-RYDER

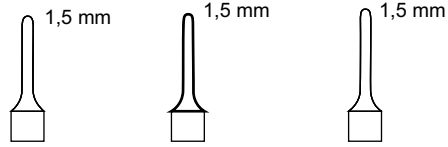

Typ / Type	13 cm – 5"	15 cm – 6"	18 cm – 7"
TC	OZ-6059-63	OZ-6059-65	OZ-6059-68

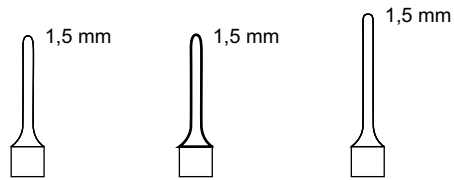

Typ / Type	20 cm – 8"	23 cm – 9"	26 cm – 10¼"
TC	OZ-6059-70	OZ-6059-73	OZ-6059-76



Körnung 0,3 mm
Grit 7000 tpsi

OZZE (SWEDISH PATTERN)

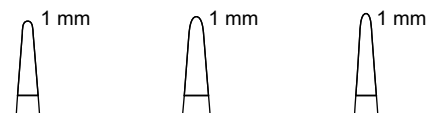

Typ / Type	15 cm – 6"	17 cm – 6¾"	20 cm – 8"
TC	OZ-6060-01	OZ-6060-02	OZ-6060-03



Nadelhalter Needle Holders

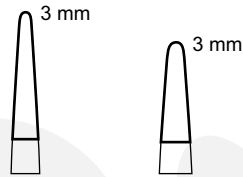

Typ / Type	18 cm – 7"	26 cm – 10¼"
TC	OZ-6060-18	OZ-6060-26





OZZE MEDICAL & SURGICAL SUPPLIES
TOOLS TO OPERATE

Nadelhalter Needle Holders

Körnung 0,4 mm
Grit 3600 tpsi



STRATTE



Typ / Type	23 cm – 9"
TC	OZ-6061-23

Körnung 0,5 mm
Grit 2500 tpsi



MASSON

1:3

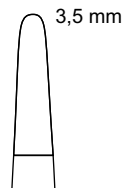

Typ / Type	27 cm – 10½"
TC	OZ-6062-27

Nadelhalter Needle Holders

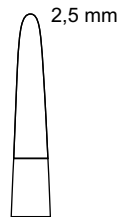

Typ / Type	27 cm – 10½"
TC	OZ-6063-27

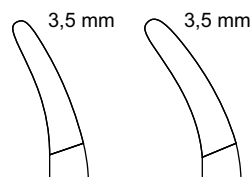

Typ / Type	20 cm – 8"	27 cm – 10½"
TC	OZ-6064-20	OZ-6064-27

Nadelhalter Needle Holders

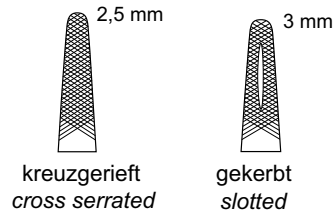

14 cm – 5½"	OZ-6040-14	OZ-6042-14
17 cm – 6¾"	OZ-6040-17	OZ-6042-17
20 cm – 8"	OZ-6040-20	OZ-6042-20



Körnung 0,4 mm
Grit 3600 tpsi

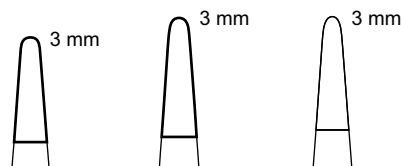

Typ / Type	14 cm – 5½"	17 cm – 6¾"	20 cm – 8"
TC	OZ-6065-14	OZ-6065-17	OZ-6065-20



Nadelhalter Needle Holders

Körnung 0,5 mm
Grit 2500 tpsi



MATHIEU

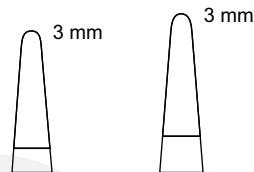

Typ / Type	17 cm – 6¾"	20 cm – 8"
TC	OZ-6066-17	OZ-6066-20

Körnung 0,5 mm
Grit 2500 tpsi



MATHIEU-KOHLER

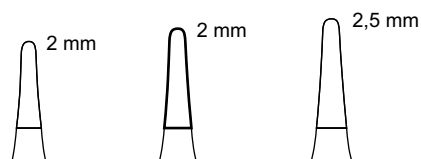

Typ / Type	14 cm – 5½"	17 cm – 6¾"	20 cm – 8"
TC	OZ-6070-14	OZ-6070-17	OZ-6070-20



OZZE MEDICAL & SURGICAL SUPPLIES
TOOLS TO OPERATE

Nadelhalter Needle Holders



Körnung 0,5 mm
Grit 2500 tpsi

schweres Modell,
mit Innensperre
*heavy pattern,
with special ratchet*

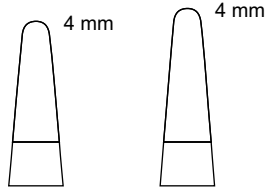

Typ / Type	20 cm – 8"	24 cm – 9½"
TC	OZ-6072-20	OZ-6072-24

MATHIEU

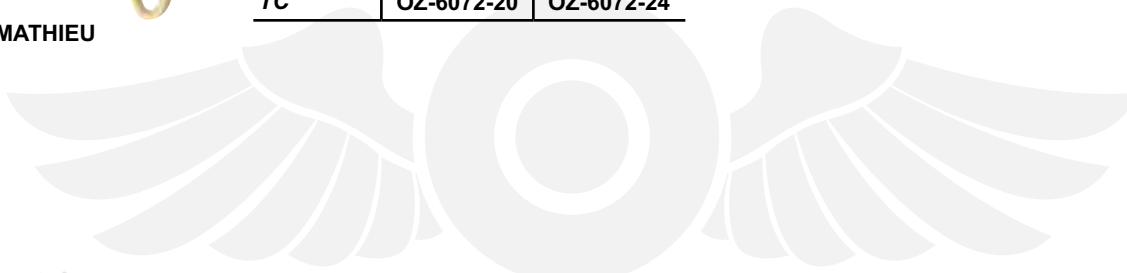

Körnung 0,5 mm
Grit 2500 tpsi

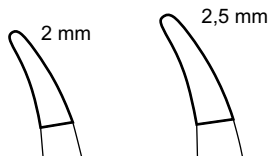

Typ / Type	17 cm – 6¾"	20 cm – 8"
TC	OZ-6073-17	OZ-6073-20

MATHIEU-METZENBAUM



OZZE MEDICAL & SURGICAL SUPPLIES
TOOLS TO OPERATE

Unterbindungsnadeln Ligature Needles



rechts
right

13 cm – 5"

OZ-6118-15

KRONECKER



links
left

13 cm – 5"

OZ-6119-15

KRONECKER



rechts
right

links
left

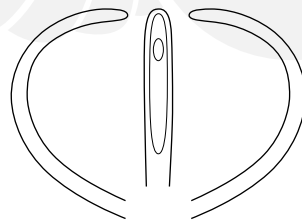

rechts, stumpf links, stumpf
right, blunt left, blunt

20 cm – 8"

OZ-6100-20

OZ-6102-20

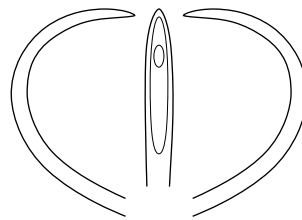

rechts, scharf links, scharf
right, sharp left, sharp

20 cm – 8"

OZ-6104-20

OZ-6106-20

DESCHAMPS-STANDARD



rechts
right

links
left

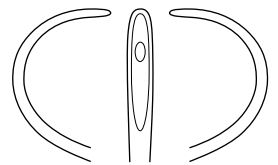

rechts, stumpf links, stumpf
right, blunt left, blunt

20 cm – 8"

OZ-6108-01

OZ-6108-02

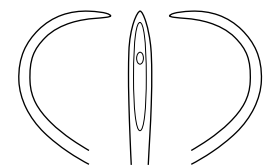

rechts, scharf links, scharf
right, sharp left, sharp

20 cm – 8"

OZ-6108-03

OZ-6108-04

DESCHAMPS-STANDARD



OZZE MEDICAL & SURGICAL SUPPLIES
TOOLS TO OPERATE

Unterbindungsnadeln Ligature Needles

rechts
right



links
left



DESCHAMPS

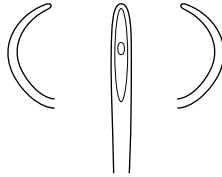

rechts, stumpf, steile Biegung
right, blunt, steep turn

links, stumpf, steile Biegung
left, blunt, steep turn

22,5 cm – 8¾"

OZ-6105-01

OZ-6105-02

rechts
right



links
left



DESCHAMPS

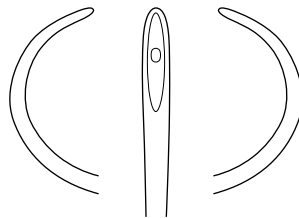

rechts, stumpf, steile Biegung
right, blunt, steep turn

links, stumpf, steile Biegung
left, blunt, steep turn

22,5 cm – 8¾"

OZ-6105-03

OZ-6105-04



Unterbindungsnadeln Ligature Needles

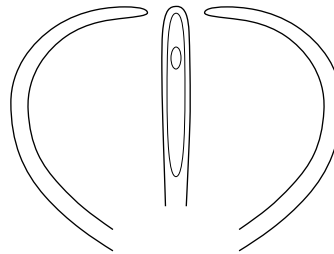
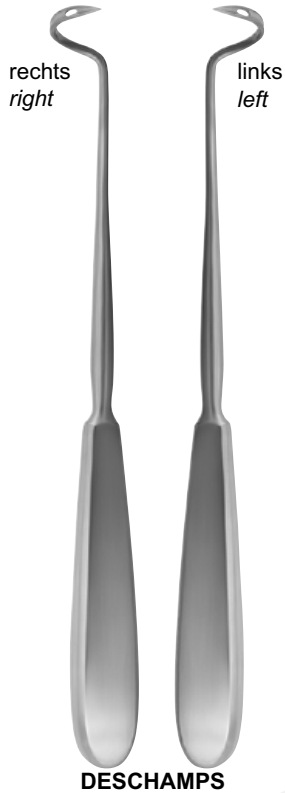

rechts, stumpf links, stumpf
right, blunt left, blunt

21 cm – 8¼"

OZ-6110-21 | **OZ-6112-21**

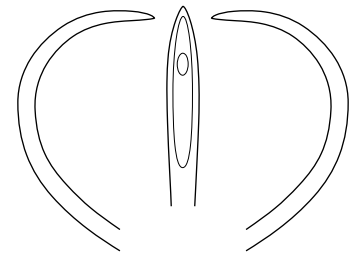

rechts, scharf links, scharf
right, sharp left, sharp

21 cm – 8¼"

OZ-6114-21 | **OZ-6116-21**

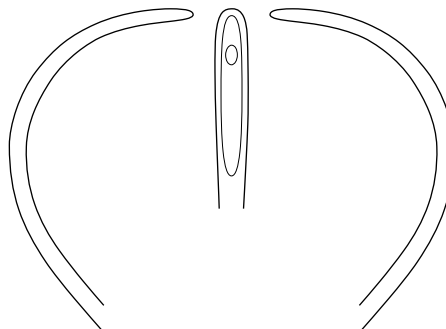
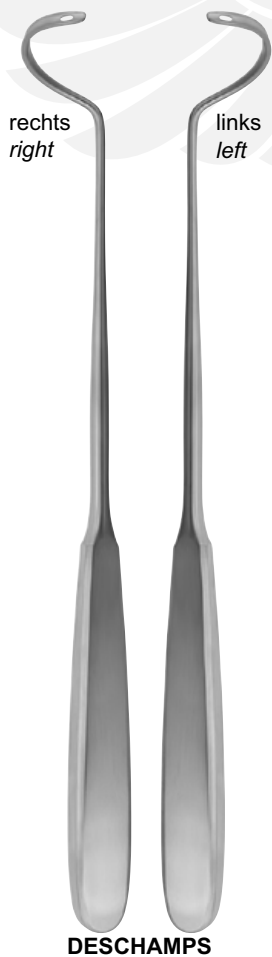

rechts, stumpf links, stumpf
right, blunt left, blunt

24 cm – 9½"

OZ-6110-24 | **OZ-6112-24**



Unterbindungsnadeln Ligature Needles

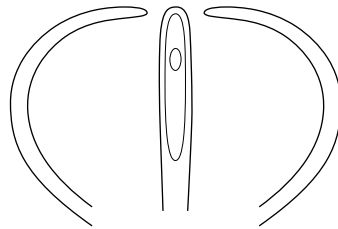

rechts, stumpf
right, blunt

links, stumpf
left, blunt

27 cm – 10½"

OZ-6110-27

OZ-6112-27

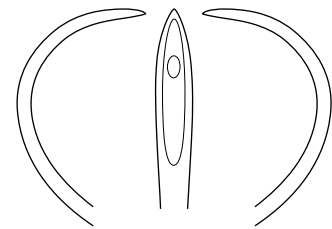

rechts, scharf
right, sharp

links, scharf
left, sharp

27 cm – 10½"

OZ-6114-27

OZ-6116-27

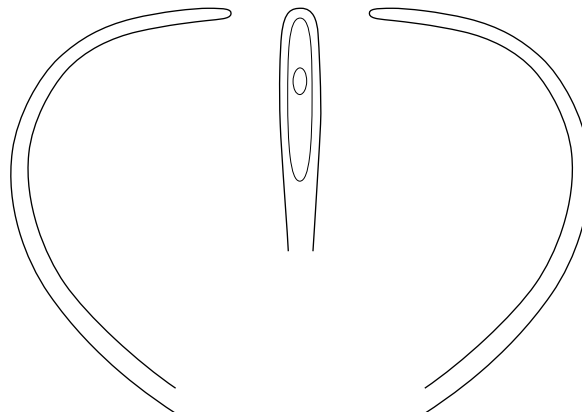

rechts, stumpf
right, blunt

links, stumpf
left, blunt

28 cm – 11"

OZ-6110-28

OZ-6112-28



OZZE MEDICAL & SURGICAL SUPPLIES
TOOLS TO OPERATE

Unterbindungsnadeln Ligature Needles

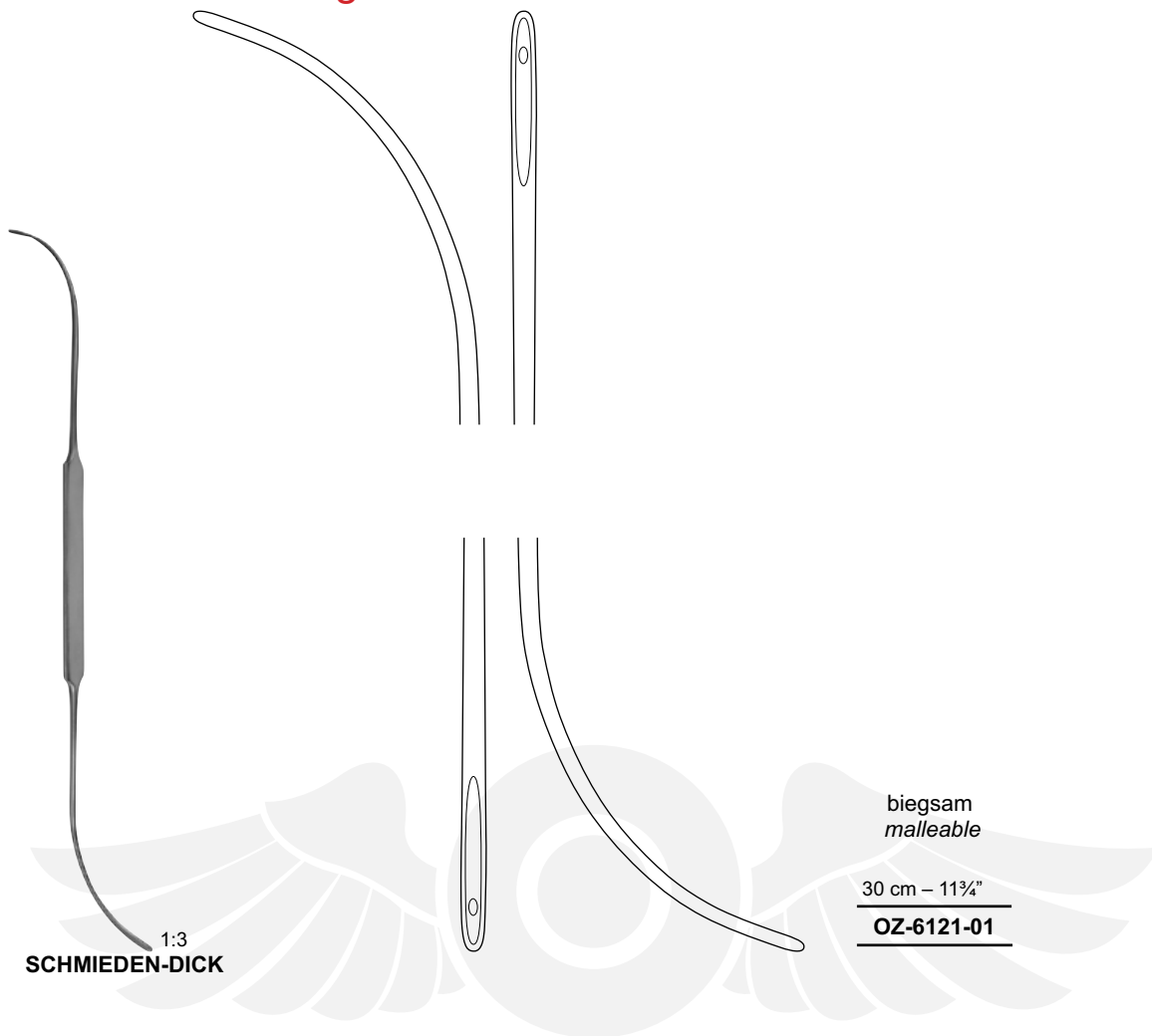

1:3
SCHMIEDEN-DICK

biegsam
malleable

30 cm – 11¾"

OZ-6121-01

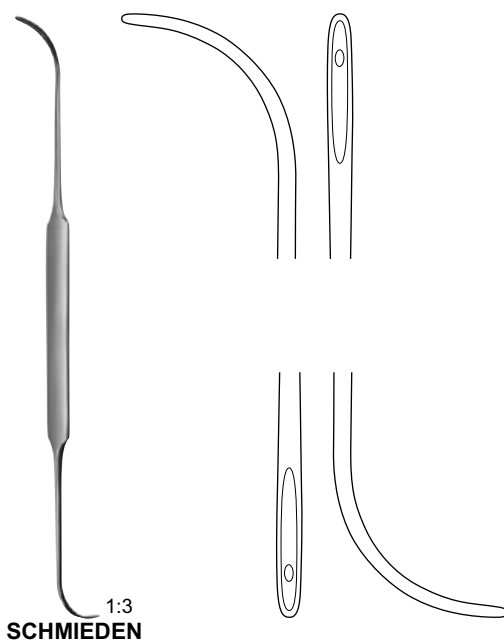

1:3
SCHMIEDEN

für die linke Hand
for left hand

24 cm – 9½"

OZ-6121-21



OZZE MEDICAL & SURGICAL SUPPLIES
TOOLS TO OPERATE

Unterbindungsnadeln Ligature Needles



biegsam
malleable

21 cm – 8¼"

OZ-6123-20



18,5 cm – 7¼"

OZ-6124-19

COOPER



Reverdin Nadeln Reverdin Needles



REVERDIN



Fig. 1



Fig. 2



Fig. 3



Fig. 4

14,5 cm – 5 3/4"

OZ-6126-01	OZ-6126-02	OZ-6126-03	OZ-6126-04
------------	------------	------------	------------



REVERDIN



Fig. 1



Fig. 2



Fig. 3



Fig. 4

19,5 cm – 7 3/4"

OZ-6127-01	OZ-6127-02	OZ-6127-03	OZ-6127-04
------------	------------	------------	------------

Reverdin Nadeln Reverdin Needles



Fig. 1



Fig. 2

22,5 cm – 8¾"

OZ-6128-01	OZ-6128-02
-------------------	-------------------



REVERDIN



Fig. 3



Fig. 4

22,5 cm – 8¾"

OZ-6128-03	OZ-6128-04
-------------------	-------------------



OZZE MEDICAL & SURGICAL SUPPLIES
TOOLS TO OPERATE

Führungs-Hohlsonden Guiding Probes



gebogen
curved

19,5 cm – 7¾"

OZ-6131-19

PAYR



gerade
straight

22 cm – 8¾"

OZ-6130-22

PAYR

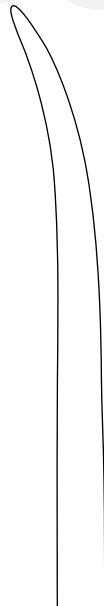

gebogen
curved

22 cm – 8¾"

OZ-6131-22

PAYR



Führungs-Hohlsonden Guiding Probes

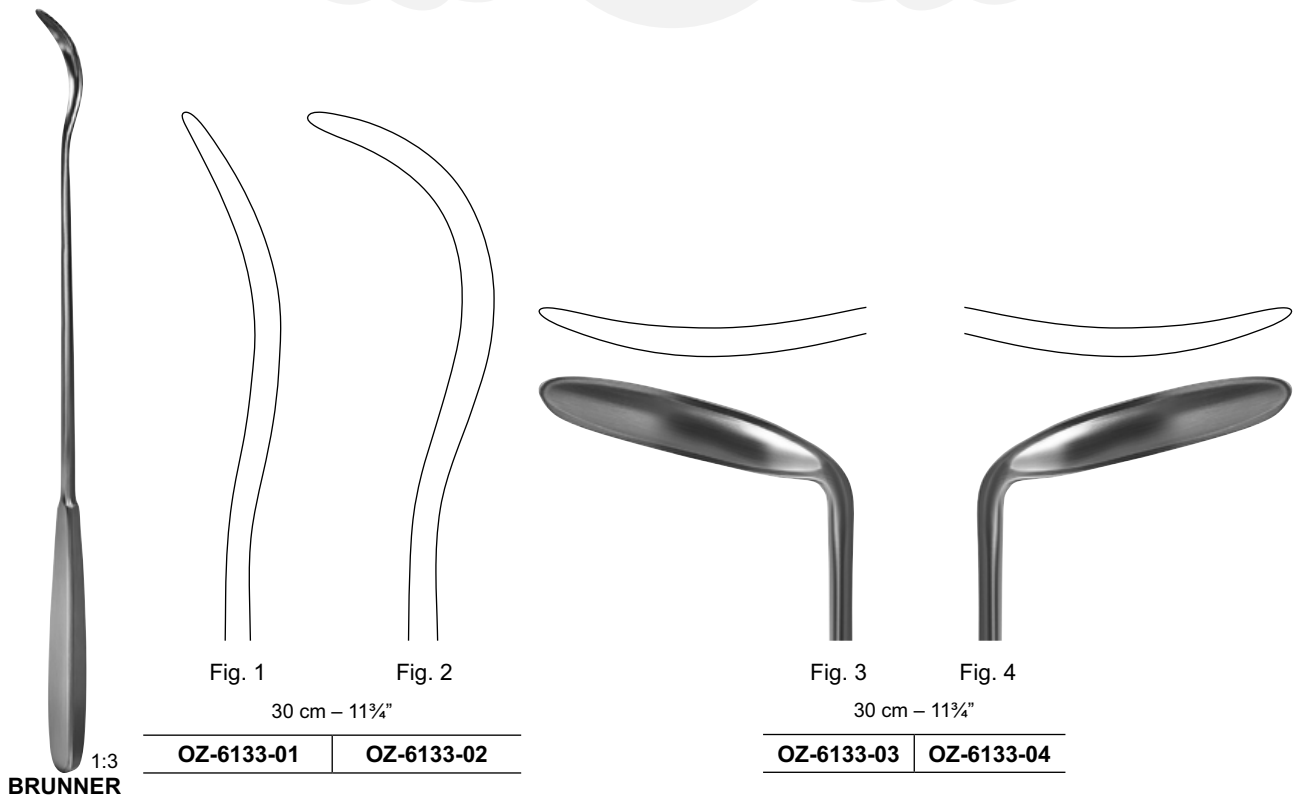
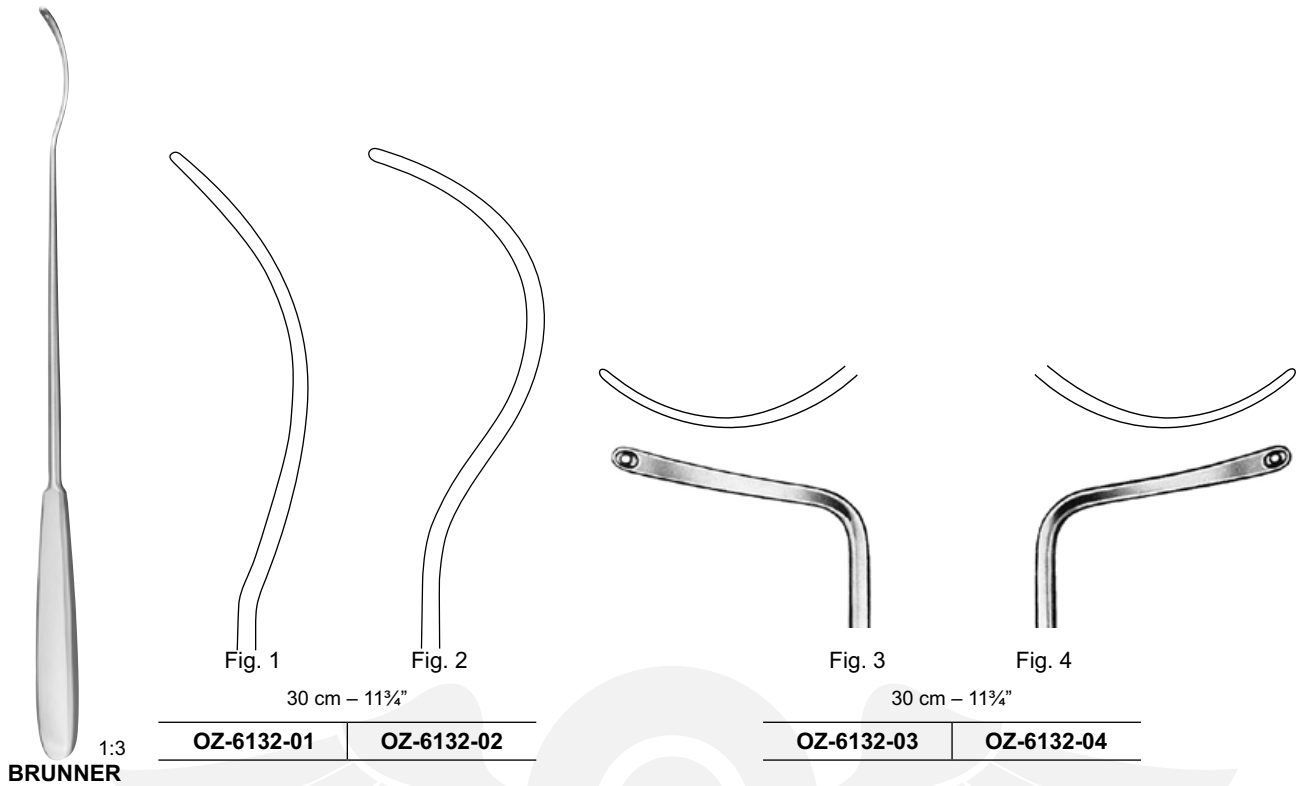

Führungs-Hohlsonden Guiding Probes

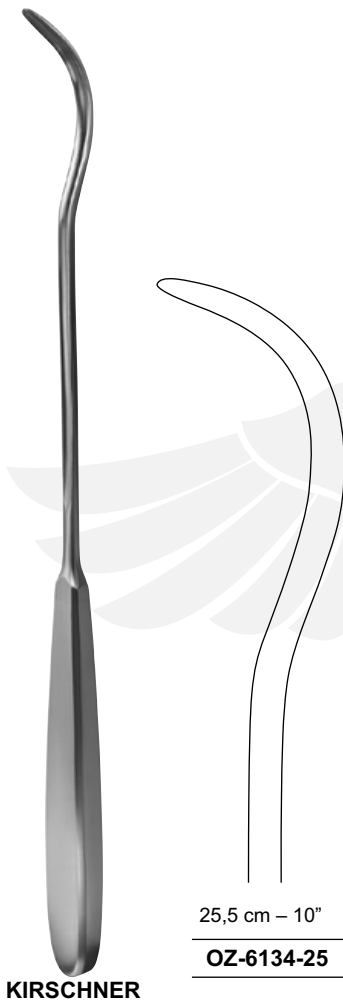

Aus Kunststoff-Hartgewebe
sterilisierbar im Autoklav

*Of plastic material,
can be sterilised in an
autoclave*

18 cm – 7"	OZ-6136-18
25 cm – 10"	OZ-6136-24
27 cm – 10½"	OZ-6136-27



OZZE MEDICAL & SURGICAL SUPPLIES
TOOLS TO OPERATE

Führungs-Hohlsonden Guiding Probes



19 cm – 7½"

OZ-6139-19

SCHMIEDEN-PAYR



19 cm – 7½"

OZ-6140-19

SCHMIEDEN



19,5 cm – 7¾"

OZ-6141-19

KÖNIG



19,5 cm – 7¾"

OZ-6142-19

KÖNIG



OZZE MEDICAL & SURGICAL SUPPLIES
TOOLS TO OPERATE

Führungs-Hohlsonden Guiding Probes



KÖNIG



20 cm – 8"

OZ-6143-20



Fadenfänger
Suture hook

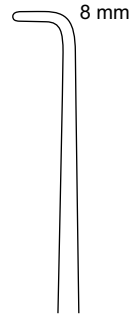

23,5 cm – 9 1/4"

OZ-6145-23

1:3
**MODELL WIEN
VIENNA PATTERN**



Fadengabel
Knottier



23 cm – 9"

OZ-6147-23



Wundklammern Suture Clips



Klammeranlege- und
Entfernungszange
*Clip applying and
removing forceps*

12 cm – 4¾"

OZ-6150-12

MICHEL

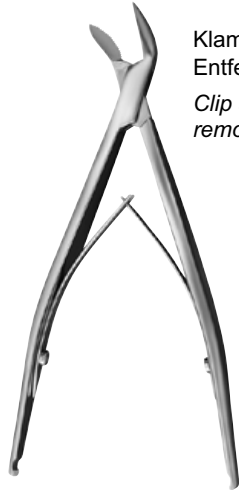

Klammeranlege- und
Entfernungszange
*Clip applying and
removing forceps*

12,5 cm – 5"

OZ-6151-12

MICHEL



Klammeranlege- und
Entfernungszange
*Clip applying and
removing forceps*

13 cm – 5"

OZ-6152-13

COLLIN

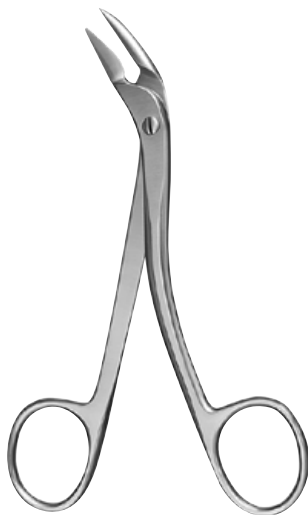

RICHTER-HEATH

14 cm – 5½"

OZ-6153-14

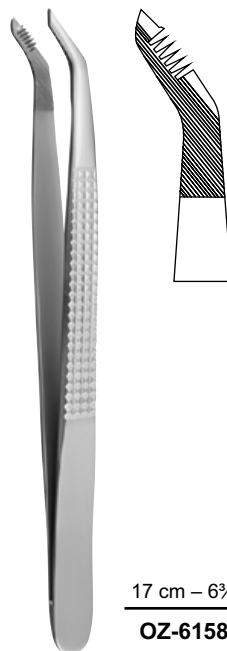

CHILD

17 cm – 6¾"

OZ-6158-01



OZZE MEDICAL & SURGICAL SUPPLIES
TOOLS TO OPERATE

Klammeranlegepinzetten Clip Applying Forceps



12 cm – 4¾"

OZ-6164-12

MICHEL



12 cm – 4¾"

OZ-6165-12

WACHENFELDT



12,5 cm – 5"

OZ-6168-12

HEGENBARTH

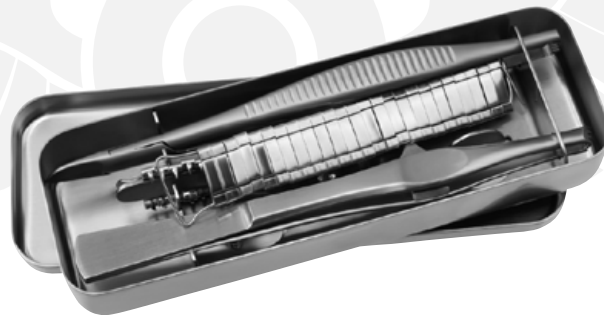

MICHEL

Wundklammerbesteck komplett, bestehend aus:
Suture clip set complete, consisting of:

OZ-6170-00

1 Wundklammerzange (OZ-6150-12)
1 Clip applying forceps (OZ-6150-12)
1 Wundrand-Fasspinzette mit Klammerhalter (OZ-6165-01)
1 Wound grasping forceps with clip holder (OZ-6165-01)
50 Wundklammern
50 Suture clips



Chirurgisches Taschenbesteck Pocket Instrument Set

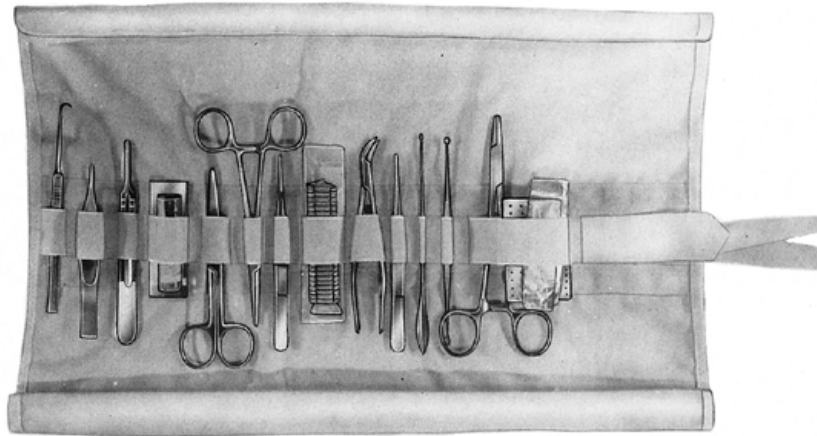

Chirurgisches Taschenbesteck komplett, bestehend aus:
Pocket instrument set complete, consisting of:

OZ-6180-00

- 1 Arterienklemme Crile, 14 cm - 5½", gerade (OZ-3074-14)
- 1 Hemostatic forceps, 14 cm - 5½", straight (OZ-3074-14)
- 1 Häkchen Bergmann, 14 cm - 5½", scharf (OZ-4469-14)
- 1 Hook Bergmann, 14 cm - 5½", sharp (OZ-4469-14)
- 1 Skalpellgriff No. 4, 13,5 cm - 5¼" (OZ-4850-04)
- 1 Scalpel handle No. 4, 13.5 cm - 5¼" (OZ-4850-04)
- 1 Myrtenblattsonde, 13 cm - 5" (OZ-4914-13)
- 1 Myrtle blade probe, 13 cm - 5" (OZ-4914-13)
- 1 Doppellöffel Williger, 13,5 cm - 5¼", Ø 4,2 / 3,5 mm, scharf (OZ-5368-12)
- 1 Double curette Williger, 13.5 cm - 5¼", Ø 4.2 / 3.5 mm, sharp (OZ-5368-12)
- 1 Nadelhalter Mayo-Hegar, 16 cm - 6¼", gerade (OZ-6000-16)
- 1 Needle holder Mayo-Hegar, 16 cm - 6¼", straight (OZ-6000-16)
- 1 Nadeldose gelocht, 50 x 25 x 4,5 mm (OZ-8910-50)
- 1 Needle case perforated, 50 x 25 x 4.5 mm (OZ-8910-50)
- 1 Nadeldose gelocht, 75 x 25 x 4,5 mm (OZ-8910-75)
- 1 Needle case perforated, 75 x 25 x 4.5 mm (OZ-8910-75)
- 1 Chirurgische Schere, 13 cm - 5", spitz / stumpf, gerade (OZ-1002-13)
- 1 Surgical scissors, 13 cm - 5", sharp / blunt, straight (OZ-1002-13)
- 1 Anatomische Pinzette Standard, 13 cm - 5", gerade (OZ-4000-13)
- 1 Dressing forceps Standard, 13 cm - 5", straight (OZ-4000-13)
- 1 Chirurgische Pinzette Standard, 13 cm - 5", 1 : 2 Zähne, gerade (OZ-4100-13)
- 1 Tissue forceps Standard, 13 cm - 5", 1 : 2 teeth, straight (OZ-4100-13)
- 1 Splitterpinzette Feilchenfeld, 11,5 cm - 4½", gerade (OZ-4320-11)
- 1 Splinter forceps Feilchenfeld, 11.5 cm - 4½", straight (OZ-4320-11)
- 1 Wundklammerzängchen Michel modif., 12,5 cm - 5" (OZ-6151-12)
- 1 Clip applying forceps Michel modif., 12.5 cm - 5" (OZ-6151-12)
- 1 Rolltasche allein, im Autoklav sterilisierbar (OZ-6180-00/01)
- 1 Pocket bag, only, autoclavable (OZ-6180-00/01)
- 1 Metalletui allein (OZ-8979-00)
- 1 Metal case, only, (OZ-8979-00)

Venae Sectio Besteck

Venae Sectio Set

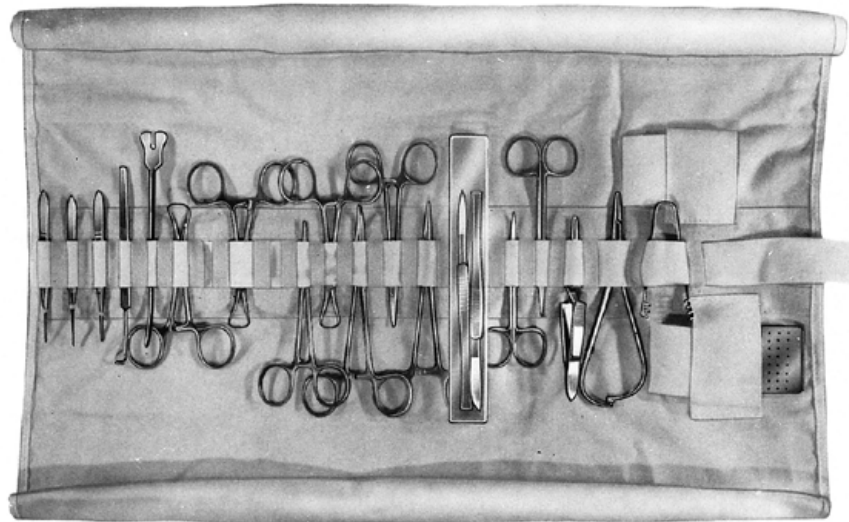

Venae Sectio Besteck komplett, bestehend aus:
Venae sectio set complete, consisting of:

OZ-6185-00

- 1 Schere, 10,5 cm - 4¼", fein, gebogen (OZ-1631-10)
- 1 Scissors, 10.5 cm - 4¼", delicate, curved (OZ-1631-10)
- 1 Gefässschere mit Knopf, 11,5 cm - 4½", gerade (OZ-1705-11)
- 1 Coronary scissors with ball-end, 11.5 cm - 4½", straight (OZ-1705-11)
- 1 Anatomische Pinzette, 10 cm - 4", fein, gerade (OZ-4250-10)
- 1 Dressing forceps, 10 cm - 4", delicate, straight (OZ-4250-10)
- 1 Chirurgische Pinzette, 10,5 cm - 4¼", fein, gerade, 1 : 2 Zähne (OZ-4260-10)
- 1 Tissue forceps, 10.5 cm - 4¼", delicate, straight, 1 : 2 teeth (OZ-4260-10)
- 1 Wundsperrer Finsen, 7 cm - 2¾", feststellbar, scharf (OZ-4642-07)
- 1 Retractor Finsen, 7 cm - 2¾", lockable, sharp (OZ-4642-07)
- 1 Hohlsonde Doyen, 14,5 cm - 5¾", gebogen (OZ-4911-14)
- 1 Probe Doyen, 14.5 cm - 5¾", curved (OZ-4911-14)
- 1 Nadelhalter Mathieu, 14 cm - 5½", gerade (OZ-6040-14)
- 1 Needle holder Mathieu, 14 cm - 5½", straight (OZ-6040-14)
- 1 Unterbindungsnadel Kronecker, 13 cm - 5", links (OZ-6118-15)
- 1 Ligation needle Kronecker, 13 cm - 5", left (OZ-6118-15)
- 1 Klammeranlegezange Hegenbarth, 12,5 cm - 5", 2 : 3 Zähne (OZ-6168-12)
- 1 Clip applying forceps Hegenbarth, 12.5 cm - 5", 2 : 3 teeth (OZ-6168-12)
- 1 Chirurgische Pinzette Micro-Adson-Bierner, 12 cm - 4¾", fein, gerade, 1 : 2 Zähne (OZ-4131-12)
- 1 Tissue forceps Micro-Adson-Bierner, 12 cm - 4¾", delicate, straight, 1 : 2 teeth (OZ-4131-12)
- 2 Arterienklemme Halstead-Mosquito, 12,5 cm - 5", gebogen (OZ-3101-12)
- 2 Hemostatic forceps Halstead-Mosquito, 12.5 cm - 5", gebogen (OZ-3101-12)
- 2 Arterienklemme Halstead-Mosquito, 12,5 cm - 5", gerade, 1 : 2 Zähne (OZ-3110-12)
- 2 Hemostatic forceps Halstead-Mosquito, 12.5 cm - 5", straight, 1 : 2 teeth (OZ-3110-12)
- 3 Tuchklemme Backhaus, 9 cm - 3½" (OZ-3600-09)
- 3 Towel forceps Backhaus, 9 cm - 3½" (OZ-3600-09)
- 1 Anatomisches Skalpell, Fig. 1, spitz (OZ-4858-01)
- 1 Dissecting Scalpel, Fig. 1, pointed (OZ-4858-01)
- 1 Anatomisches Skalpell, Fig. 6, spitz (OZ-4858-06)
- 1 Dissecting Scalpel, Fig. 6, pointed (OZ-4858-06)
- 1 Nadeldose gelocht, 50 x 25 x 4,5 mm (OZ-8910-50)
- 1 Needle case perforated, 50 x 25 x 4.5 mm (OZ-8910-50)
- 1 Rolltasche allein, im Autoklav sterilisierbar (OZ-6180-00/01)
- 1 Pocket bag, only, autoclavable (OZ-6180-00/01)
- 1 Metalletui allein (OZ-8979-00)
- 1 Metal case, only, (OZ-8979-00)



OZZE MEDICAL & SURGICAL SUPPLIES
TOOLS TO OPERATE

Gipsverband-Instrumente Plaster cast instruments



Gipsmesser
Plaster knives

20 cm – 8"

OZ-6210-20

HOPKINS



Gipsmesser
Plaster knives

18 cm – 7"

OZ-6212-18

ESMARCH



Gipsmesser
Plaster knives

18,5 cm – 7¼"

OZ-6214-18

REINER



Gipssäge
Plaster saw

15 cm – 6"

OZ-6225-14

ENGEL



Gipsspreizer
Plaster spreader

28 cm – 11"

OZ-6230-28

HENNING

Gipsverband-Instrumente Plaster cast instruments



Gipsspreizer
Plaster spreader

23 cm – 9"

OZ-6234-23

1:3

**MODELL USA
USA PATTERN**



Gipsabreißzange
Plaster breaker

18 cm – 7"

OZ-6240-18

24 cm – 9½"

OZ-6240-24

WOLFF

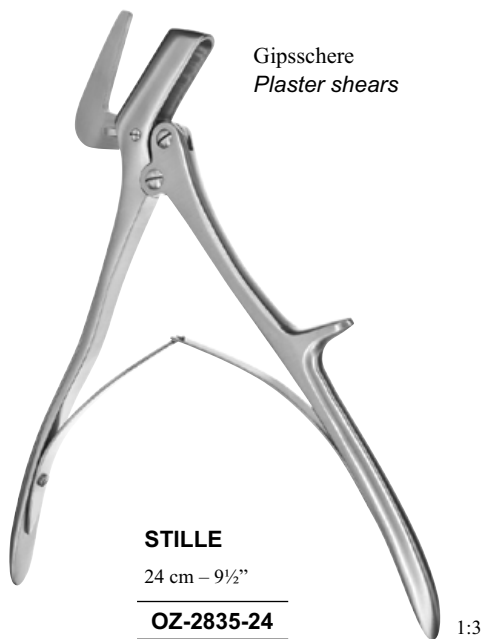

Gipsschere
Plaster shears

STILLE

24 cm – 9½"

OZ-2835-24

1:3



Gipsschere
Plaster shears

Messer mit verstärktem Rücken
Blade with reinforced back

23 cm – 9"

OZ-2840-23

26 cm – 10¼"

OZ-2840-26

37 cm – 14½"

OZ-2840-37

STILLE

1:3



OZZE MEDICAL & SURGICAL SUPPLIES
TOOLS TO OPERATE

Gipsverband-Instrumente Plaster cast instruments

Gipssägen mit oszillierenden Sägeblättern
Plaster saws with oscillating saw blades



inkl. Sägeblätter
incl. saw blades
OZ-6220-83
OZ-6220-85

Standard
Standard

OZ-6220-20



inkl. Sägeblätter
incl. saw blades
OZ-6220-83
OZ-6220-85

Akku
Accu

OZ-6220-22



inkl. Sägeblätter
incl. saw blades
OZ-6220-84
OZ-6220-85

ECO-Version
ECO Version

OZ-6220-24

Zubehör für OZ-6220-22 Accessories for OZ-6220-22



Akku (1700 mAh)
für oszillierender Gipssäge (OZ-6220-22)
Battery, rechargeable, (1700 mAh) for
oscillating plaster saw (OZ-6220-22)

OZ-6220-41



Schnell-Ladegerät für Akku
(OZ-6220-41)
Quick recharger for accu
(OZ-6220-41)

OZ-6220-42

Zubehör Accessories

Koffer für oszillierende Gipssägen (OZ-6220-20 Standard, OZ-6220-24 ECO-Version) Case for oscillating plaster saws (OZ-6220-20 Standard, OZ-6220-24 ECO-Version)	OZ-6220-31
Koffer für oszillierende Gipssäge (OZ-6220-22 ACCU) Case for oscillating plaster saw (OZ-6220-22 ACCU)	OZ-6220-32



Gipsverband-Instrumente Plaster cast instruments

Sägeblätter (autoklavierbar)
Material: rostfreier Edelstahl
Saw blades (autoclavable)
Material: stainless steel

Rundsägeblatt
Round saw blade



	Gips Plaster	Synthetik Syntetic
Ø 44 mm	OZ-6220-80	OZ-6220-81
Ø 50 mm	OZ-6220-82	OZ-6220-83
Ø 65 mm	OZ-6220-84	OZ-6220-85



Segment-Sägeblatt
Segment saw blade

	Gips Plaster	Synthetik Syntetic
Ø 65 mm	OZ-6220-86	OZ-6220-87



Taillen-Sägeblatt
Wasted saw blade

	Gips Plaster	Synthetik Syntetic
Ø 65 mm	OZ-6220-88	OZ-6220-89



Tiefensägeblatt
Deep saw blade

	Gips Plaster	Synthetik Syntetic
Ø 70 mm	OZ-6220-91	OZ-6220-92



Gipssäge, komplett mit Staubsauger, bestehend aus:

Plaster saw, complete with vacuum cleaner consisting of:

OZ-6220-51

- 1 Gipssäge, oszillierend (OZ-6220-20 inkl. OZ-6220-83 und OZ-6220-85)
- 1 Plaster saw, oscillating (OZ-6220-20 incl. OZ-6220-83 and OZ-6220-85)
- 1 Sauger (OZ-6220-60)
- 1 Vacuum cleaner (OZ-6220-60)
- 1 Schlauch (RZ6220-62)
- 1 Tube (RZ6220-62)
- 1 Schlauchhalter (RZ6220-70)
- 1 Hose clamp (RZ6220-70)
- 1 Absaugglocke (RZ6220-68)
- 1 Dust removal unit (RZ6220-68)
- 1 Adapterkabel (RZ6220-73)
- 1 Adaptercable (RZ6220-73)
- 1 Werkzeug (RZ6220-71)
- 1 Tool (RZ6220-71)

Staubsauger ohne Zubehör

Vacuum cleaner without accessories

OZ-6220-60

Optional:

- Aufhängung mit Griff, höhenverstellbar (RZ6220-69), nur für OZ-6220-20 und OZ-6220-22 geeignet - Magnetische Ablage (RZ6220-72)

Optional:

- Hanging kit with handle, height adjustable (RZ6220-69), suitable only for OZ-6220-20 and 6220-22 - Magnetic placement (RZ6220-72)



©ZZE MEDICAL & SURGICAL SUPPLIES

TOOLS TO OPERATE



EIGHT

🖱 www.ozzesurgical.com.au

✉ info@ozzesurgical.com.au

Abdominale Chirurgie

Abdominal Surgery

Darm- und Gewebefasszangen	<i>Intestinal and Tissue Grasping Forceps</i>	AS 1 - 6
Darmklemmen	<i>Intestinal Clamps</i>	AS 7 - 13
Magenklemmen	<i>Stomach Clamps</i>	AS 14
Magen- und Darmquetschklemmen	<i>Intestinal and Pylorus Clamps</i>	AS 15
Magen- und Darm-Zwillingsklemmen	<i>Stomach and Intestinal Twin Clamps</i>	AS 16
Anastomosenklemmen	<i>Anastomosis Clamps</i>	AS 17
Rektum-Anastomosenklemmen	<i>Sigmoid Anastomosis Clamps</i>	AS 18 - 19
Rektum-Spekula	<i>Rectal Specula</i>	AS 20 - 21
Rektoskope	<i>Rectoscopes</i>	AS 22 - 23
Analspreizer	<i>Rectal Spreader</i>	AS 24
Rektum-Biopsiefasszange	<i>Rectal Biopsy Forceps</i>	AS 25
Hämorrhoidalzangen	<i>Haemorrhoidal Forceps</i>	AS 26 - 27
Hämorrhoidal-Ligatoren	<i>Haemorrhoidal Ligators</i>	AS 28 - 30
Gallenkanal-Klemmzangen	<i>Gall Duct Forceps</i>	AS 31 - 32
Gallenkanal Instrumente	<i>Gall Duct Instruments</i>	AS 33 - 34
Nierenklemmen	<i>Kidney Clamps</i>	AS 35
Nierensteinzangen	<i>Kidney Stone Forceps</i>	AS 36
Blasenwundspreizer	<i>Bladder Retractors</i>	AS 37 - 38
Urologie-Instrumente	<i>Urology Instruments</i>	AS 39 - 43



OZZE MEDICAL & SURGICAL SUPPLIES
TOOLS TO OPERATE

Darm- und Gewebefasszangen Intestinal and Tissue Grasping Forceps

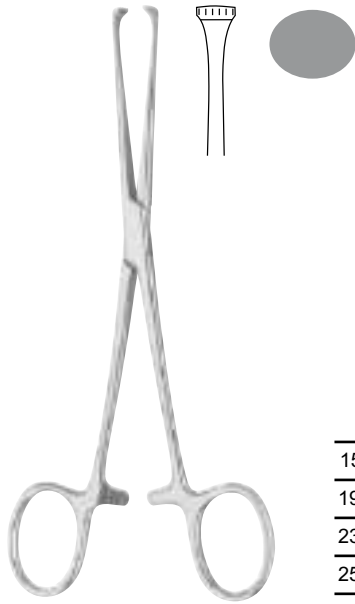

ALLIS

	4 : 5 Zähne 4 : 5 teeth	5 : 6 Zähne 5 : 6 teeth
15 cm – 6"	OZ-6500-15	OZ-6502-15
19 cm – 7½"	–	OZ-6502-19
23 cm – 9"	–	OZ-6502-23
25 cm – 10"	–	OZ-6502-25



BABY-ALLIS

	4 : 5 Zähne 4 : 5 teeth
12 cm – 4¾"	OZ-6504-12
14 cm – 5½"	OZ-6504-14



ALLIS-ATRAUOZ-

16 cm – 6¼"	OZ-6505-16
20 cm – 8"	OZ-6505-20
22 cm – 8¾"	OZ-6505-22
25 cm – 10"	OZ-6505-25
30 cm – 11¾"	OZ-6505-30



ALLIS-ADAIR

15 cm – 6"
OZ-6506-15

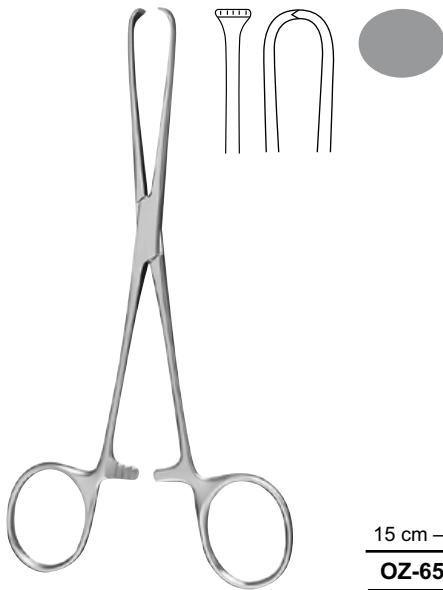

BOYS-ALLIS

15 cm – 6"
OZ-6508-15

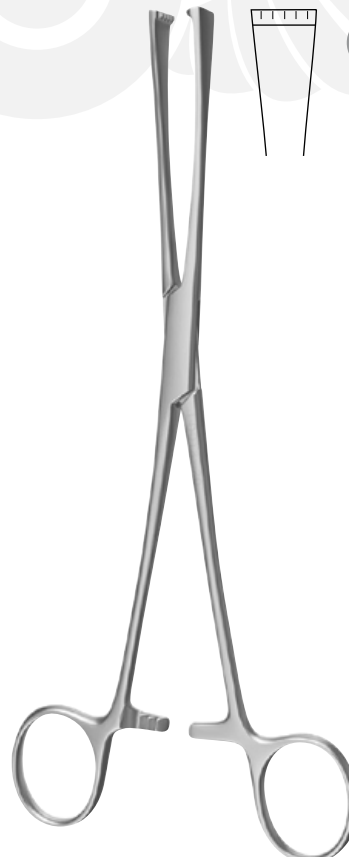

LOCKWOOD-ALLIS

	4 : 5 Zähne 4 : 5 teeth
16 cm – 6¼"	OZ-6509-16
20 cm – 8"	OZ-6509-20



Darm- und Gewebefasszangen
Intestinal and Tissue Grasping Forceps



THOMS-ALLIS

6 : 7 Zähne
6 : 7 teeth

20 cm – 8"

OZ-6510-20



JUDD-ALLIS

3 : 4 Zähne
3 : 4 teeth

15 cm – 6"

OZ-6512-15

19 cm – 7½"

OZ-6512-19

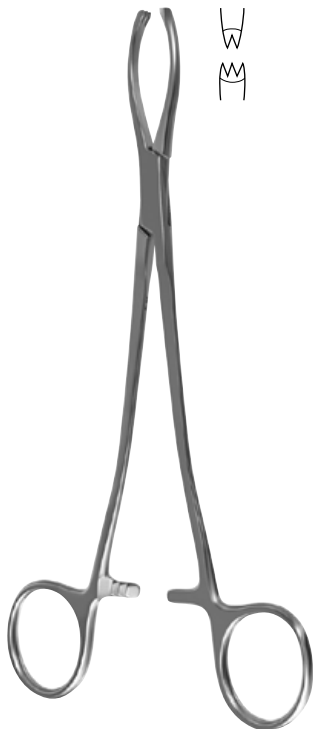

LITTLEWOOD

2 : 3 Zähne
2 : 3 teeth

18,5 cm – 7¼"

OZ-6513-18





LOCKWOOD

gefenstert
fenestrated

20 cm – 8"

OZ-6515-20

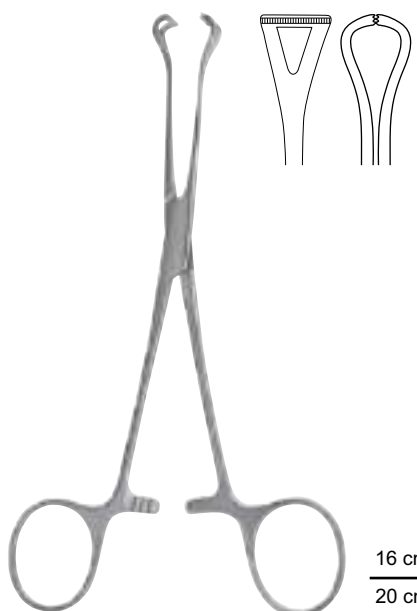
9 mm





DE BAKEY Zahnung
DE BAKEY Serration

16 cm – 6¼"	OZ-6517-16
20 cm – 8"	OZ-6517-20

BABCOCK-ATRAUOZ-

9 mm



Standardmodell
 Standard pattern

16 cm – 6¼"	OZ-6518-16
18 cm – 7"	OZ-6518-18
20 cm – 8"	OZ-6518-20
24 cm – 9½"	OZ-6518-24

BABCOCK

9 mm 12 mm

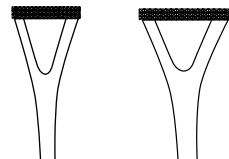

TC	16 cm – 6¼"	20 cm – 8"
	OZ-6519-16	OZ-6519-20

BABCOCK



OZZE MEDICAL & SURGICAL SUPPLIES
TOOLS TO OPERATE

Darm- und Gewebefasszangen Intestinal and Tissue Grasping Forceps

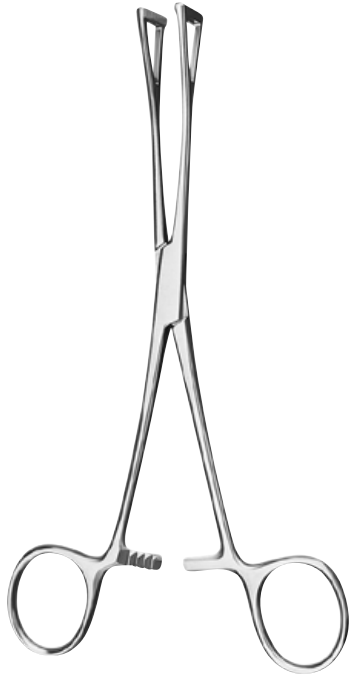

DUVAL

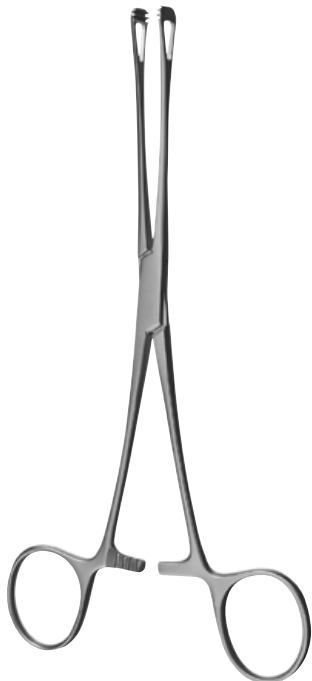
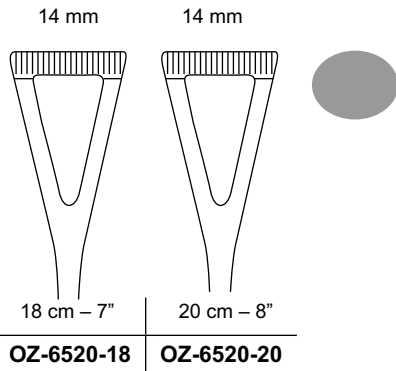

COLLIN

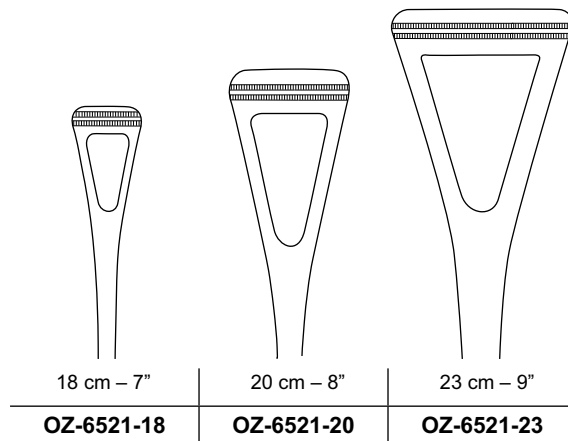



Darm- und Gewebefasszangen
Intestinal and Tissue Grasping Forceps

OZZE MEDICAL & SURGICAL SUPPLIES
TOOLS TO OPERATE

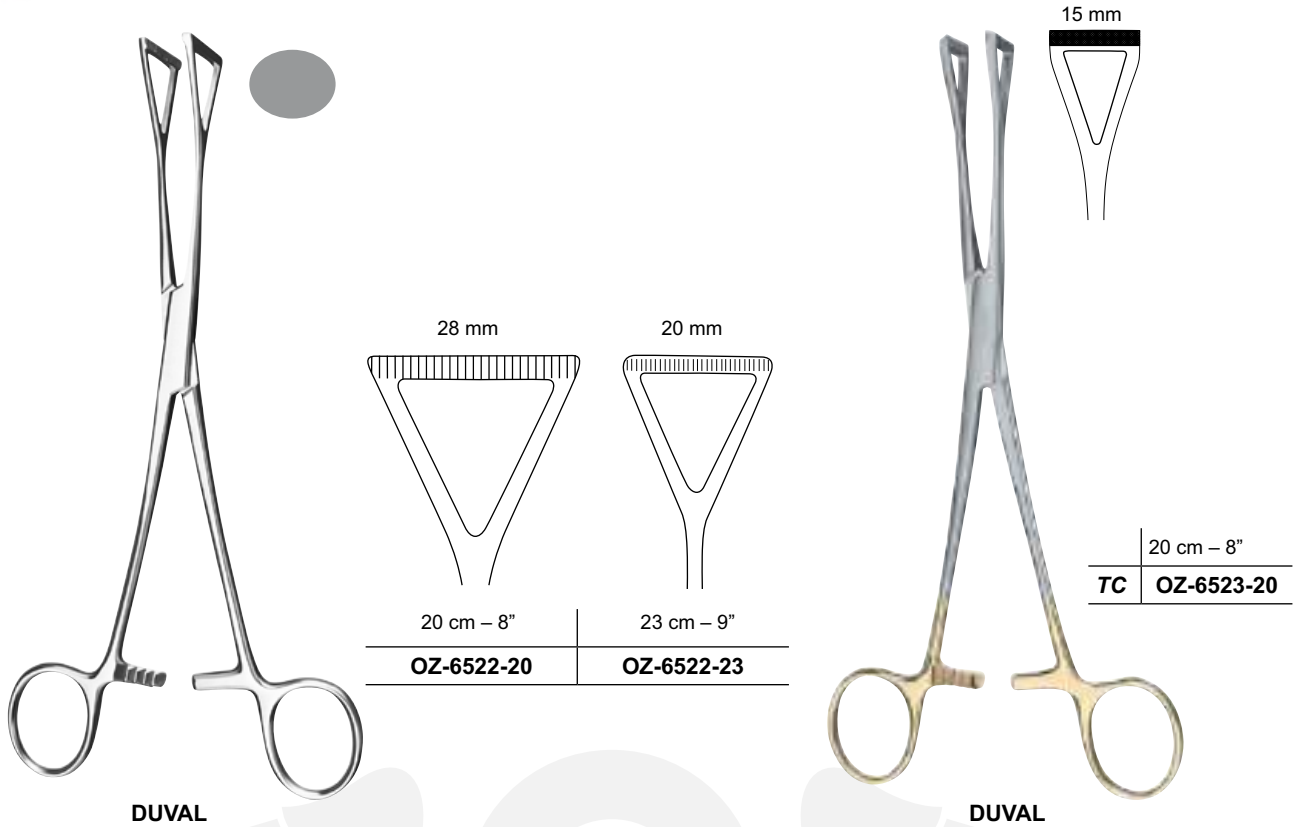

DUVAL

DUVAL

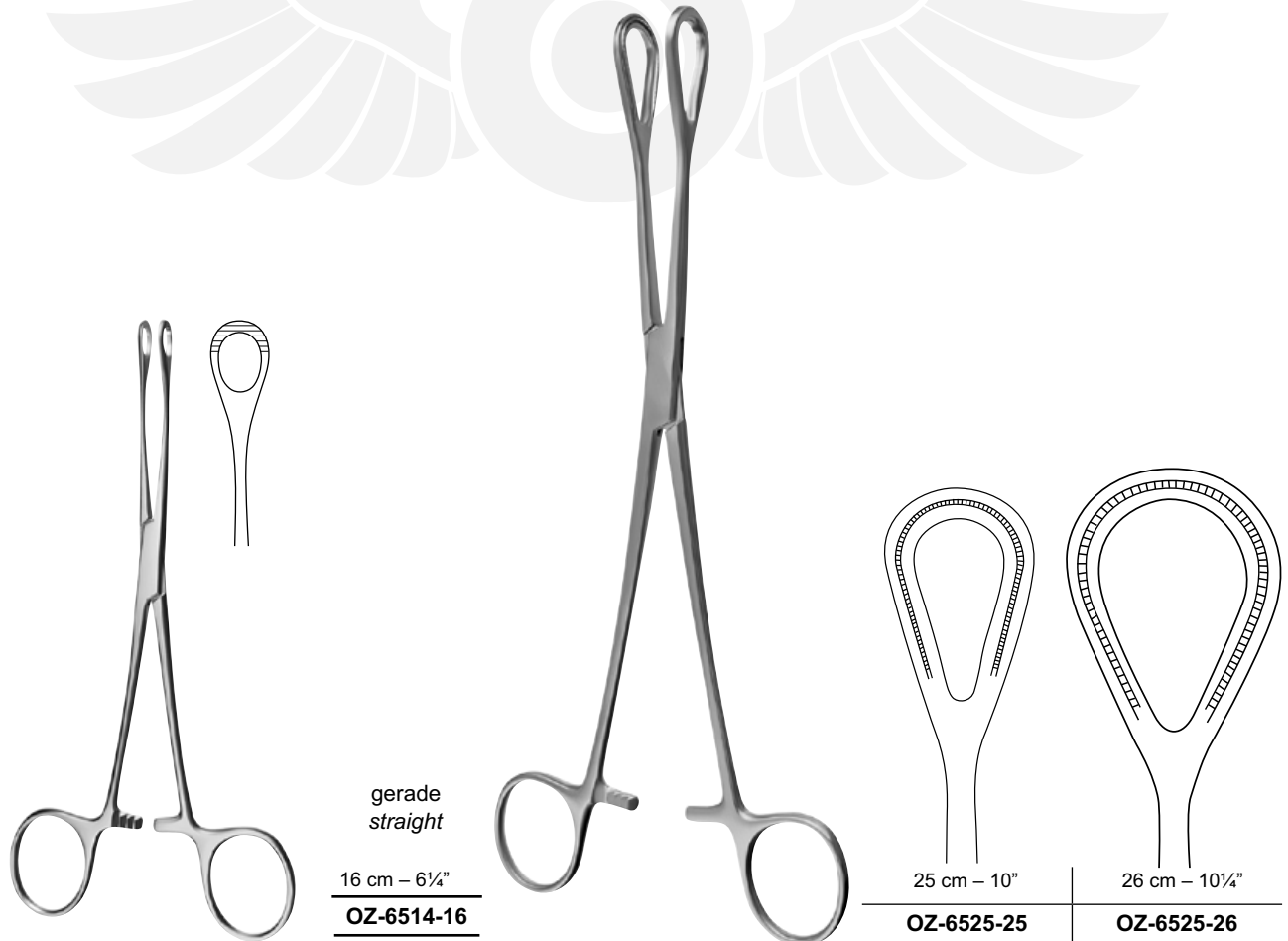

WILLIAMS



Darmklemmen Intestinal Clamps



BABY-DOYEN

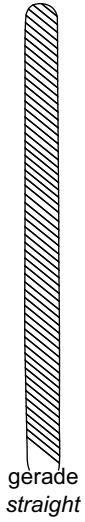

gerade
straight

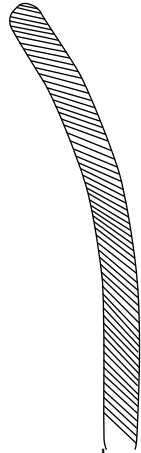

gebogen
curved

18 cm – 7"

OZ-6530-18	OZ-6531-18
-------------------	-------------------

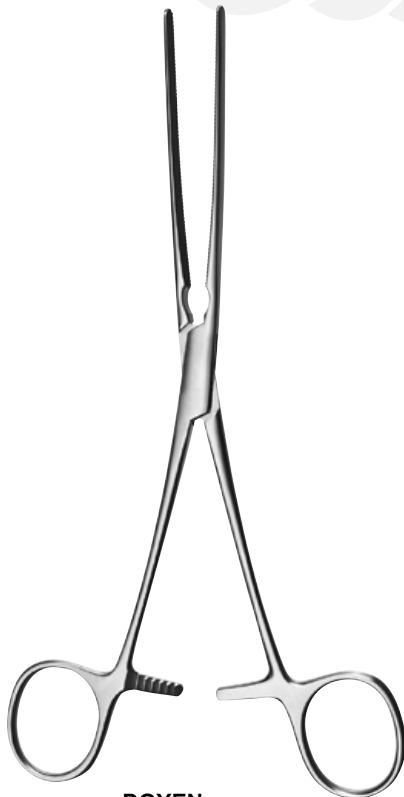
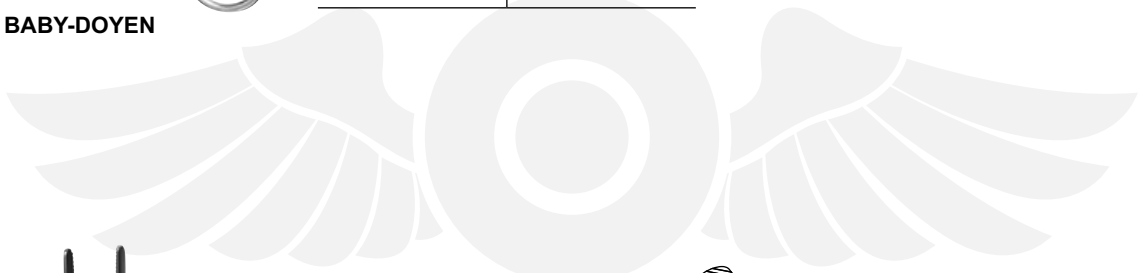

DOYEN



gerade
straight

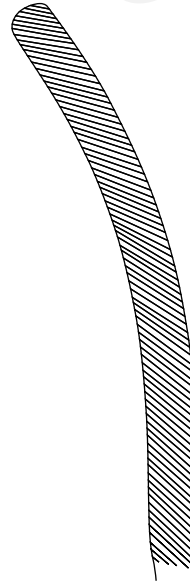

gebogen
curved

21 cm – 8¼"	OZ-6530-21	OZ-6531-21
23 cm – 9"	OZ-6530-23	OZ-6531-23



Darmklemmen Intestinal Clamps



gerade
straight



DE BAKEY Zahnung
DE BAKEY Serration



13 cm – 5"	16 cm – 6¼"	18 cm – 7"	21 cm – 8¼"	23 cm – 9"
OZ-6534-13	OZ-6534-16	OZ-6534-18	OZ-6534-21	OZ-6534-23

DOYEN-ATRAUOZ-



gebogen
curved



DE BAKEY Zahnung
DE BAKEY Serration



13 cm – 5"	16 cm – 6¼"	18 cm – 7"	21 cm – 8¼"	23 cm – 9"
OZ-6535-13	OZ-6535-16	OZ-6535-18	OZ-6535-21	OZ-6535-23

DOYEN-ATRAUOZ-



OZZE MEDICAL & SURGICAL SUPPLIES
TOOLS TO OPERATE

Darmklemmen Intestinal Clamps

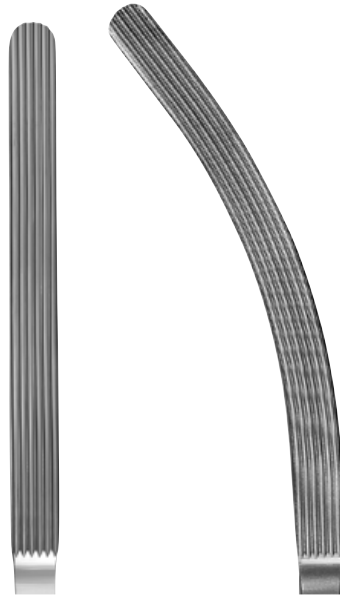

gerade
straight

gebogen
curved

21 cm – 8¼"

21 cm – 8¼"

OZ-6540-21

OZ-6541-21



MAYO-ROBSON

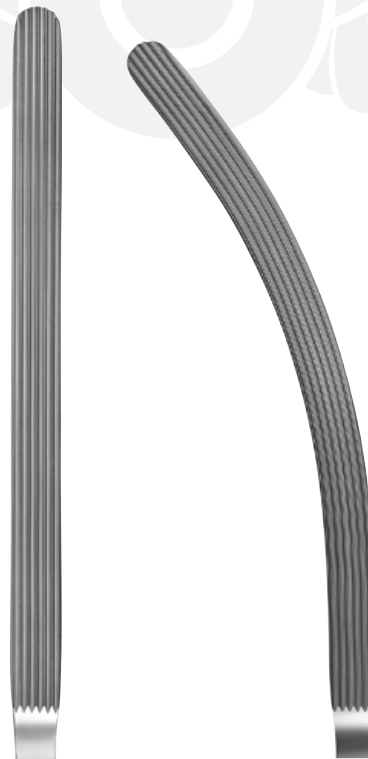

gerade
straight

gebogen
curved

23 cm – 9"

23 cm – 9"

OZ-6540-23

OZ-6541-23

Darmklemmen Intestinal Clamps



MAYO-ROBSON



OZZE MEDICAL & SURGICAL SUPPLIES
TOOLS TO OPERATE

Darmklemmen Intestinal Clamps



DE BAKEY Zahnung
DE BAKEY Serration



MAYO-ROBSON ATRAUOZ-



gerade
straight



gebogen
curved

25 cm – 10"

OZ-6542-25

OZ-6543-25

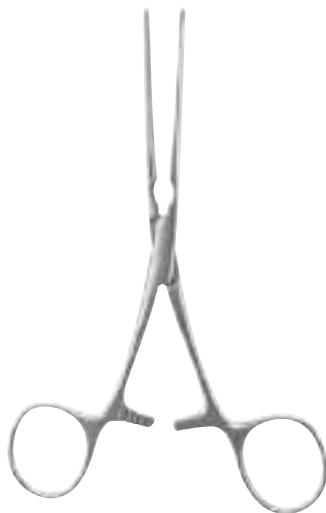

BABY-KOCHER



gerade, sehr elastisch
straight, very elastic blades



gebogen, sehr elastisch
curved, very elastic blades

13 cm – 5"

OZ-6550-13

OZ-6551-13



OZZE MEDICAL & SURGICAL SUPPLIES
TOOLS TO OPERATE

Darmklemmen Intestinal Clamps



gerade
straight

gebogen
curved

22 cm – 8¾"	25 cm – 10"	28 cm – 11"	22 cm – 8¾"	25 cm – 10"	28 cm – 11"
OZ-6550-22	OZ-6550-25	OZ-6550-28	OZ-6551-22	OZ-6551-25	OZ-6551-28

KOCHER



OZZE MEDICAL & SURGICAL SUPPLIES
TOOLS TO OPERATE

Darmklemmen Intestinal Clamps



DE BAKEY Zahnung
DE BAKEY Serration



KOCHER-ATRAUOZ-

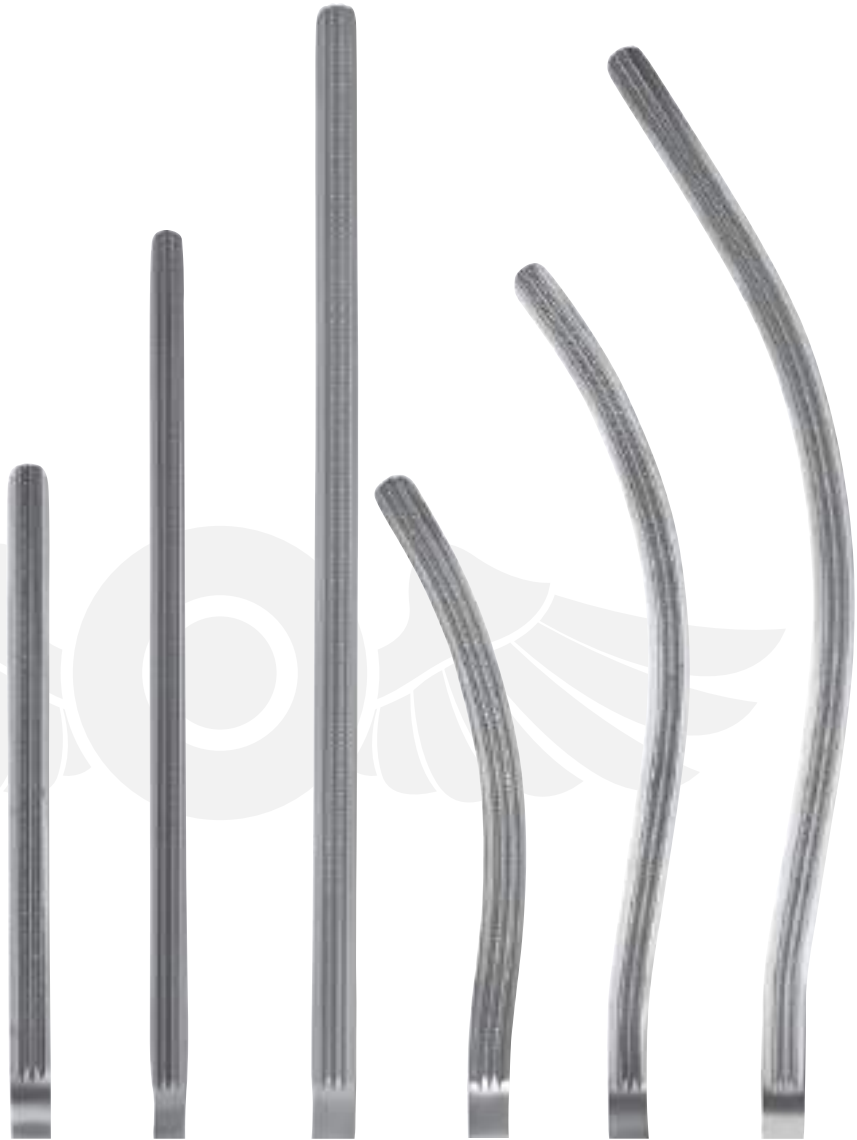

gerade
straight

gebogen
curved

22 cm – 8¾"	25 cm – 10"	28 cm – 11"	22 cm – 8¾"	25 cm – 10"	28 cm – 11"
OZ-6552-22	OZ-6552-25	OZ-6552-28	OZ-6553-22	OZ-6553-25	OZ-6553-28



Magenklemmen Stomach Clamps

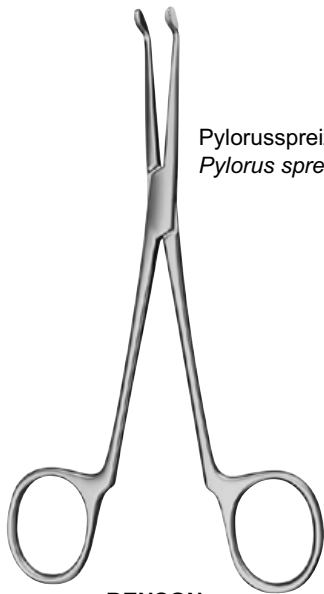

Pylorusspreizer
Pylorus spreader

BENSON



gebogen, gerieft
curved, serrated

15,5 cm – 6"

OZ-6557-15

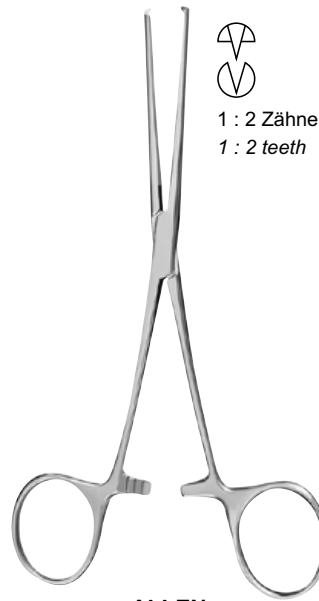

1 : 2 Zähne
1 : 2 teeth

ALLEN



straight

gerade

15,5 cm – 6"

OZ-6558-15

20 cm – 8"

OZ-6558-20

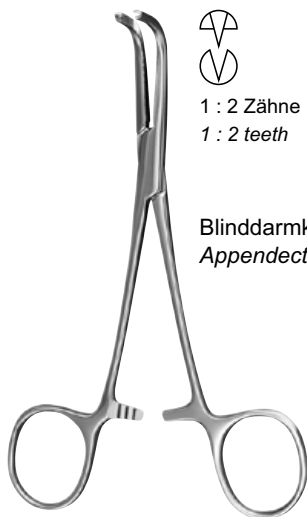

1 : 2 Zähne
1 : 2 teeth

Blinddarmklemme
Appendectomy clamp

KLEINSCHMIDT

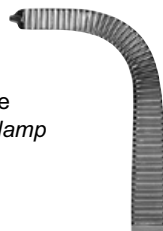

curved

12 cm – 4¾"

OZ-6559-12

gebogen



OZZE MEDICAL & SURGICAL SUPPLIES
TOOLS TO OPERATE

Magen- und Darmquetschklemmen Intestinal and Pylorus Clamps



PAYR

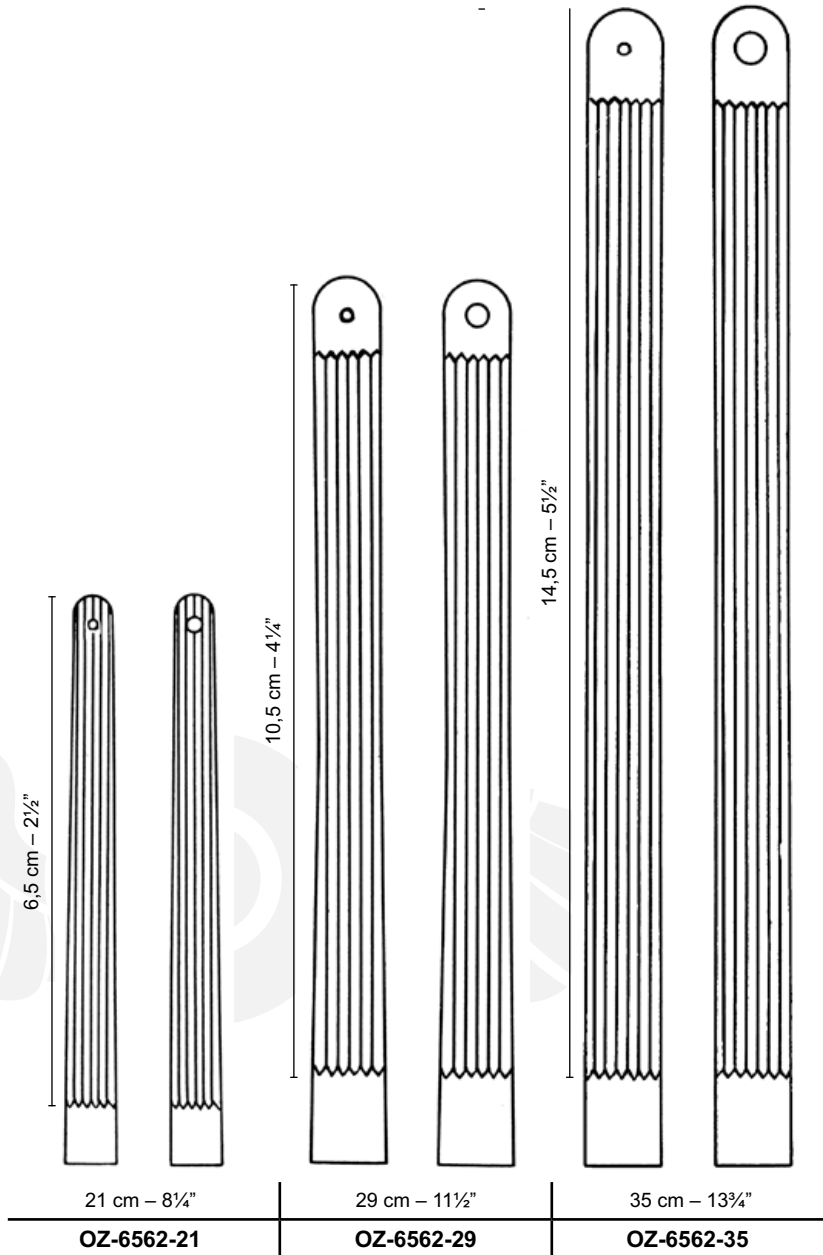



Magen- und Darm-Zwillingsklemmen
Stomach and Intestinal Twin Clamps



1:3



1:3

LANE



gerade
straight

30 cm – 11¾"

OZ-6570-30

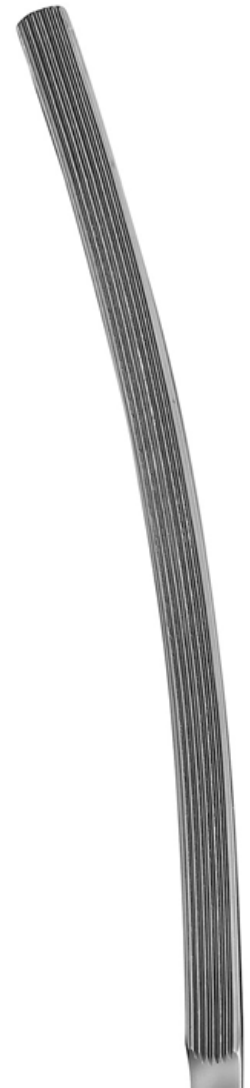

gebogen
curved

30 cm – 11¾"

OZ-6571-30



OZZE MEDICAL & SURGICAL SUPPLIES
TOOLS TO OPERATE

Anastomosenklemmen Anastomosis Clamps



Schließzange
Closing forceps

26 cm – 10¼"

OZ-6580-00

DE MARTEL-WOLFSON



DE MARTEL-WOLFSON

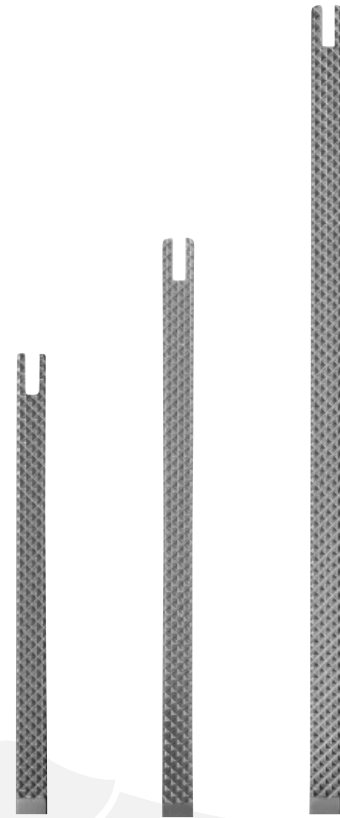

Satz von 3 Klemmen
Set of 3 clamps

5 cm – 2"

OZ-6580-05

7 cm – 2¾"

OZ-6580-07

10 cm – 4"

OZ-6580-10



Klemmenhalter
für OZ-6580-05, -07, -10

Clamp holder
for OZ-6580-05, -07, -10



8,5 cm – 3¼"

OZ-6580-20

23 cm – 9"

OZ-6580-23

DE MARTEL-WOLFSON



Rektum-Anastomosenklemmen Sigmoid Anastomosis Clamps



RESANO

1:3

30 cm – 11¾"

OZ-6544-30

OZ-6544-30



LLOYD-DAVIS

1:3

31,5 cm – 12½"

OZ-6545-31

OZ-6545-31



HAYES

1:3



DE BAKEY Zahnung
DE BAKEY Serration



26 cm – 10¼"

OZ-6546-26

OZ-6546-26



28 cm – 11"

OZ-6546-28

OZ-6546-28



OZZE MEDICAL & SURGICAL SUPPLIES
TOOLS TO OPERATE

Rektum-Anastomosenklemmen Sigmoid Anastomosis Clamps

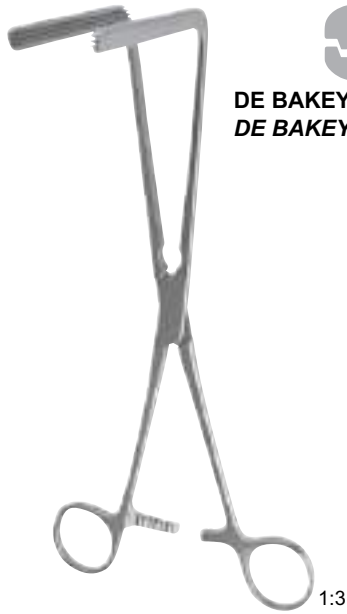

DE BAKEY Zahnung
DE BAKEY Serration

FEHLAND

1:3



90°

24 cm – 9½"

OZ-6547-24



DE BAKEY Zahnung
DE BAKEY Serration



BRUNNER

1:3



24 cm – 9½"

OZ-6548-24

OZ-6549-24



Rektum-Spekula Rectal Specula

Blattlänge
Length of blade

106 x 23 mm



CZERNY

22 cm – 8¾"

OZ-6590-22

Blattlänge
Length of blade

80 x 25 mm



PRATT

20,5 cm – 8"

OZ-6591-20



SIMS

Blattlänge
Length of blade

89 x 17 mm



15 cm – 6"

OZ-6592-15



gefenstert
fenestrated

15 cm – 6"

OZ-6593-15



Rektum-Spekula Rectal Specula



SIMS

Gesamtlänge Total length	Blattlänge Length of blade	
22 cm – 8¾"	80 x 20 mm	OZ-6595-08
	125 x 20 mm	OZ-6595-12



MATHIEU

Blattlänge
Length of blade
90 x 15 mm

19,5 cm – 7¾"
OZ-6596-19



BARR

Blattlänge
Length of blade
70 x 22 mm

17 cm – 6¾"
OZ-6597-17

Rektoskope
Rectoscopes

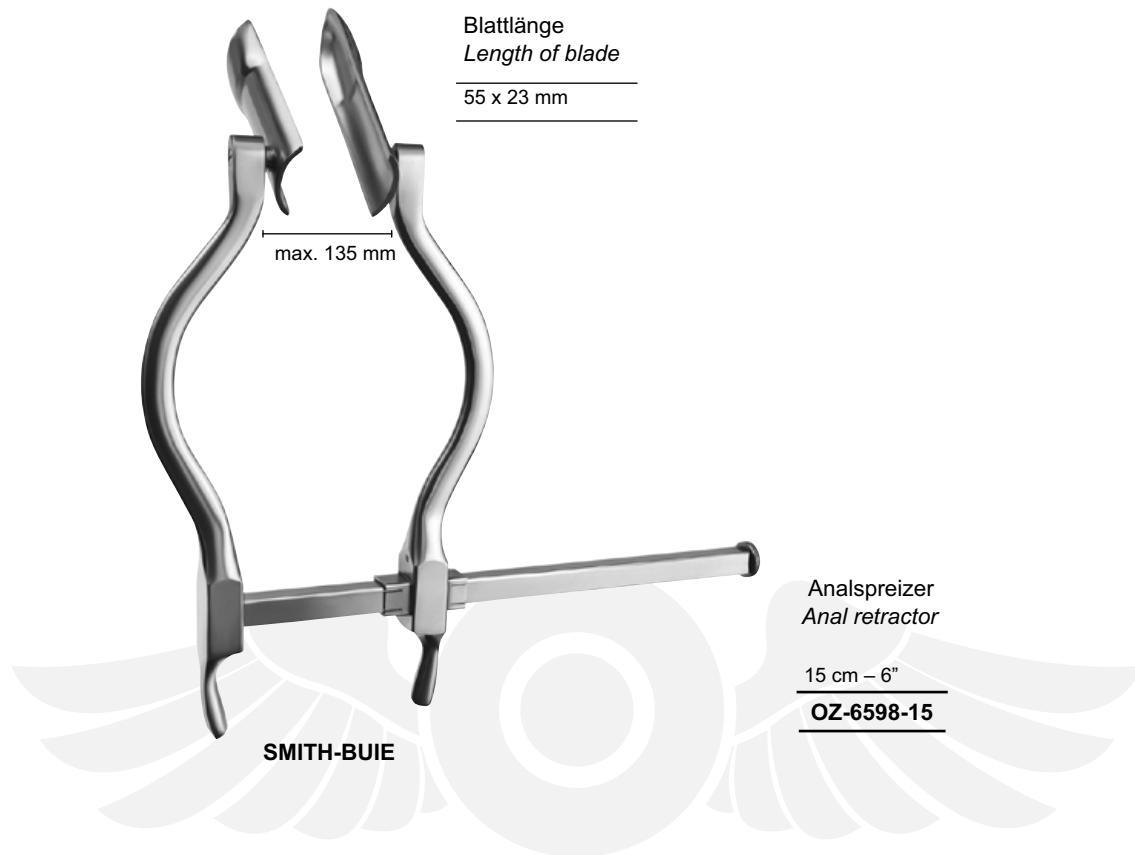

Blattlänge
Length of blade

55 x 23 mm

max. 135 mm

Anal spreizer
Anal retractor

15 cm – 6"

OZ-6598-15

SMITH-BUIE



Rektoskope Rectoscopes

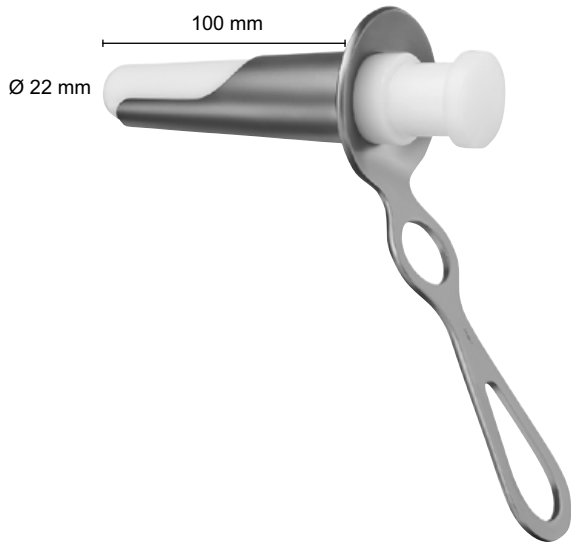

Anoskop
Anoscope

13,5 cm – 5¼"

OZ-6604-00

IVES-FANSLER

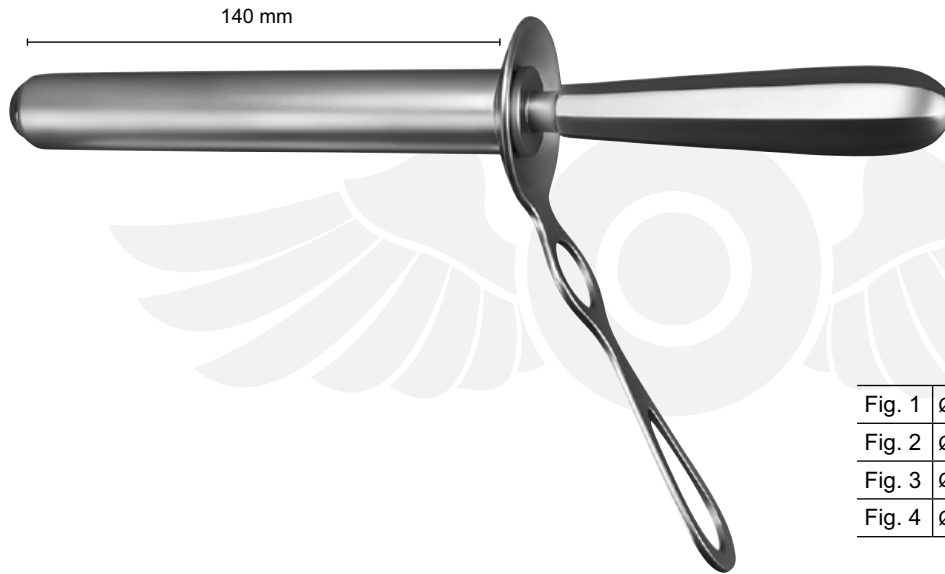

Proktoskope
Proctoscopes

Fig. 1	Ø 22 mm x 50 mm	OZ-6605-01
Fig. 2	Ø 22 mm x 100 mm	OZ-6605-02
Fig. 3	Ø 22 mm x 140 mm	OZ-6605-03
Fig. 4	Ø 22 mm x 200 mm	OZ-6605-04

KELLY



Sphinkteroskope
Sphincteroscopes

16 cm – 6¼"

Fig. 1	Ø 21 mm x 50 mm	OZ-6606-01
Fig. 2	Ø 25 mm x 50 mm	OZ-6606-02

KELLY



Analspreizer Rectal Spreader

Maßangaben für Mittelblätter
und Blätter

1. Zahl = Länge
2. Zahl = Breite

Dimensions for central blades
and blades

- 1st number = length
- 2nd number = width

Mittelblatt

Beispiel: 95 x 22 mm

Central blade

Example: 95 x 22 mm

95 mm

22 mm



Blätter

Beispiel: 60 x 25 mm

Blades

Example: 60 x 25 mm

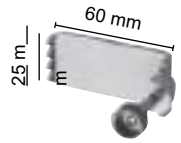

PARK

Sperrer allein <i>Retractor only</i>	OZ-6608-01
---	-------------------

Satz komplett, bestehend aus: <i>Set complete, consisting of:</i>	OZ-6608-00
--	-------------------

Sperrer allein, 14,5 cm – 5¾" (OZ-6608-01)
Retractor only, 14,5 cm – 5¾" (OZ-6608-01)

1 Mittelblatt 95 x 22 mm (OZ-6608-20)
1 Central blade 95 x 22 mm (OZ-6608-20)

1 Paar Blätter seitlich, 70 x 20 mm (OZ-6608-27)
1 pair of blades lateral, 70 x 20 mm (6608-27)

1 Paar Blätter seitlich, 90 x 20 mm (OZ-6608-29)
1 pair of blades lateral, 90 x 20 mm (6608-29)



1 Paar
1 pair

70 x 20 mm

OZ-6608-27



1 Paar
1 pair

90 x 20 mm

OZ-6608-29



Mittelblatt
Central blade

95 x 22 mm

OZ-6608-20



Rektum-Biopsiefasszangen Rectal Biopsy Forceps

Schaftlänge
Shaft length

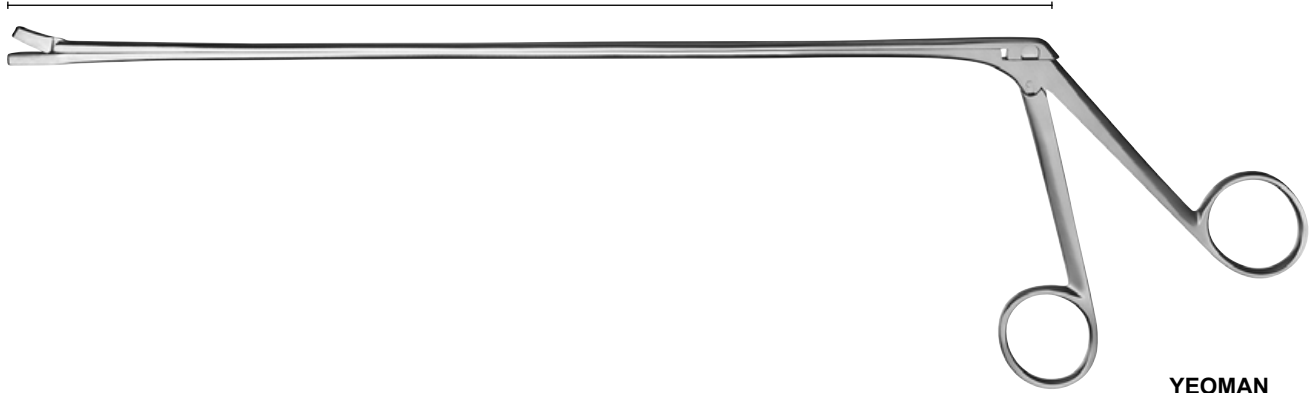

YEOMAN

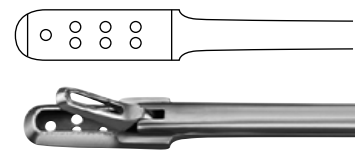
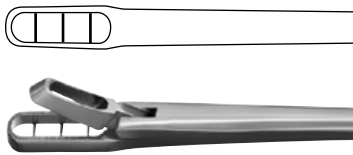

	Bissbreite Bite width	Schaftlänge Shaft length	Fig. 1
	3 mm	28 cm – 11"	OZ-6610-28
		35 cm – 13¾"	OZ-6610-35
		42 cm – 16½"	OZ-6610-42

	Bissbreite Bite width	Schaftlänge Shaft length	Fig. 2
	4 mm	28 cm – 11"	OZ-6611-28
		35 cm – 13¾"	OZ-6611-35
		42 cm – 16½"	OZ-6611-42



Hämorrhoidalzangen Haemorrhoidal Forceps



PRATT



15 cm – 6"

OZ-3150-15



FERGUSSON



gerade
straight

16 cm – 6¼"

OZ-3390-16



gebogen
curved

OZ-3391-16



HEYWOOD-SMITH



gerade
straight

21 cm – 8¼"

OZ-6616-20



HEYWOOD-SMITH



gerade
straight

21 cm – 8¼"

OZ-6617-21

Hämorrhoidalzangen Haemorrhoidal Forceps

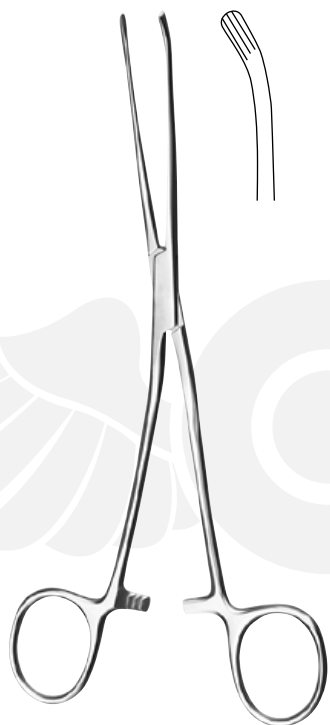

MC GIVNEY

19 cm – 7½"
OZ-6622-19

Hämorrhoidal-Ligatoren Haemorrhoidal Ligators



Hämorrhoidal-Ligator komplett, bestehend aus: <i>Haemorrhoidal ligator complete, consisting of:</i>	OZ-6620-00
--	-------------------

- 1 Hämorrhoidal-Ligator (OZ-6620-01)
- 1 *Haemorrhoidal ligator* (OZ-6620-01)
- 1 Ladekonus Ø 10 mm (OZ-6620-10)
- 1 *Charging cone* Ø 10 mm (OZ-6620-10)
- 1 Saugkopf 11 mm x Ø 10 mm (OZ-6620-11)
- 1 *Aspiration tip* 11 mm x Ø 10 mm (OZ-6620-11)
- 1 Saugkopf 16 mm x Ø 10 mm (OZ-6620-16)
- 1 *Aspiration tip* 16 mm x Ø 10 mm (OZ-6620-16)
- 1 Ligatur-Gummiringe (100 Stück) (OZ-6620-51)
- 1 *Ligature rubber rings* (100 pieces) (OZ-6620-51)



Ø 10 mm

Ladekonus
Charging cone

OZ-6620-10

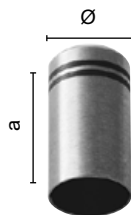

a	Ø	Saugkopf <i>Aspiration tip</i>
11 mm	10 mm	OZ-6620-11
16 mm	10 mm	OZ-6620-16



Ligatur-Gummiringe, **latexfrei**,
Verpackungseinheit 100 Stück

Ligature rubber rings, latex free,
packing unit 100 pieces

OZ-6620-51

Hämorrhoidal-Ligatoren Haemorrhoidal Ligators



Ø 12 mm

Ladekonus
 Charging cone

OZ-6621-12

Hämorrhoidal-Ligator komplett, bestehend aus:
 Haemorrhoidal ligator complete, consisting of:

OZ-6621-00

1 Hämorrhoidal-Ligator, 31,5 cm – 12½" (OZ-6621-01)
 1 Haemorrhoidal ligator, 31,5 cm – 12½" (OZ-6621-01)

1 x Ladekonus Ø 12 mm (OZ-6621-12)
 1 x Charging cone Ø 12 mm (OZ-6621-12)

1 x Ligatur-Gummiringe (100 Stück) (OZ-6620-51)
 1 x Ligature rubber rings (100 pieces) (OZ-6620-51)



Ligatur-Gummiringe, **latexfrei**,
 Verpackungseinheit 100 Stück

Ligature rubber rings, **latex free**,
 packing unit 100 pieces

OZ-6620-51

Hämorrhoidal-Ligator komplett, bestehend aus:
 Haemorrhoidal ligator complete, consisting of:

OZ-6622-00

1 x Hämorrhoidal-Ligator
 1 x Haemorrhoidal ligator

1 x Ladekonus Ø 13 mm (OZ-6622-21)
 1 x Charging cone Ø 13 mm (OZ-6622-21)

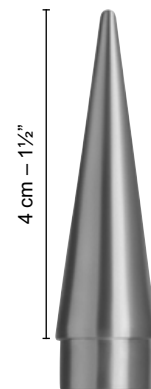
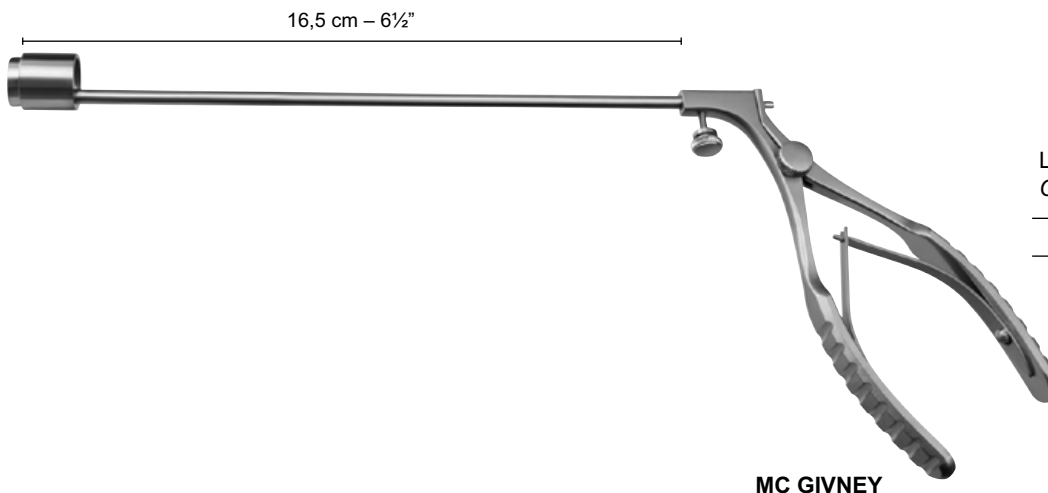

Ladekonus, Ø 13 mm
 Charging cone, Ø 13 mm

OZ-6622-21

Hämorrhoidal-Ligatoren Haemorrhoidal Ligators

Hämorrhoidal-Ligatur komplett, bestehend aus: <i>Haemorrhoidal ligator complete, consisting of:</i>	OZ-6622-05
1 x Hämorrhoidal-Ligatur <i>1 x Haemorrhoidal ligator</i>	
1 x Ladekonus Ø 13 mm (OZ-6622-21) <i>1 x Charging cone Ø 13 mm (OZ-6622-21)</i>	

latexfrei,

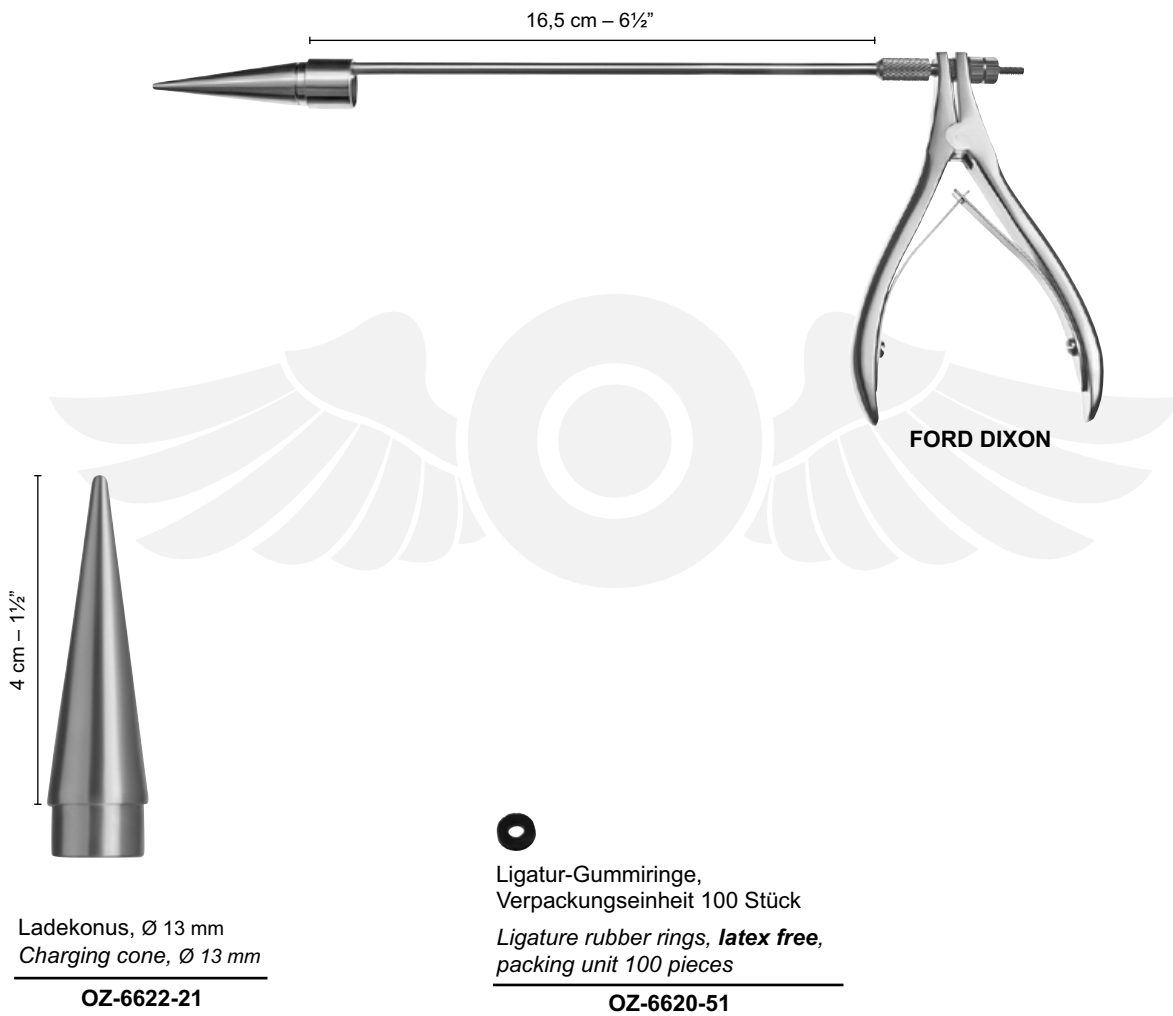



OZZE MEDICAL & SURGICAL SUPPLIES
TOOLS TO OPERATE

Gallenkanal-Klemmzangen Gall Duct Forceps



GRAY

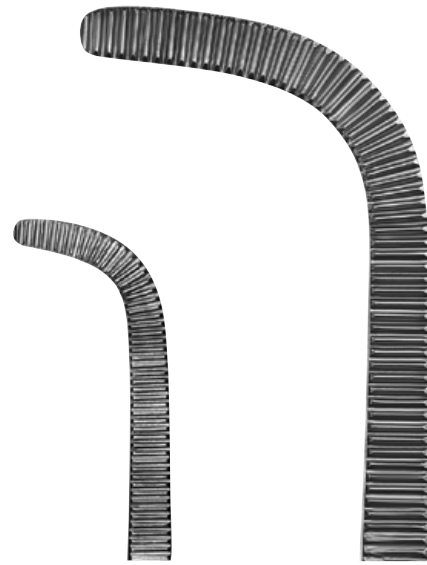
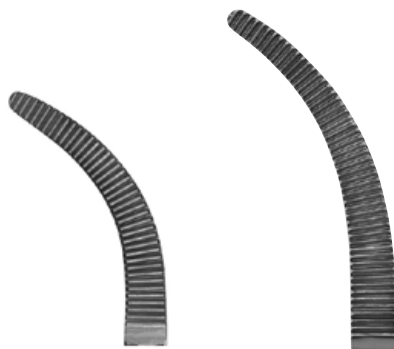

Fig. 1	Fig. 2
22 cm – 8¾"	23 cm – 9"
OZ-6642-01	OZ-6642-02

Satz à Fig. 1 und Fig. 2
Set of fig. 1 and fig. 2

OZ-6642-00



23 cm – 9"	24 cm – 9½"
OZ-3401-23	OZ-3401-24

Gallenkanal-Klemmzangen Gall Duct Forceps

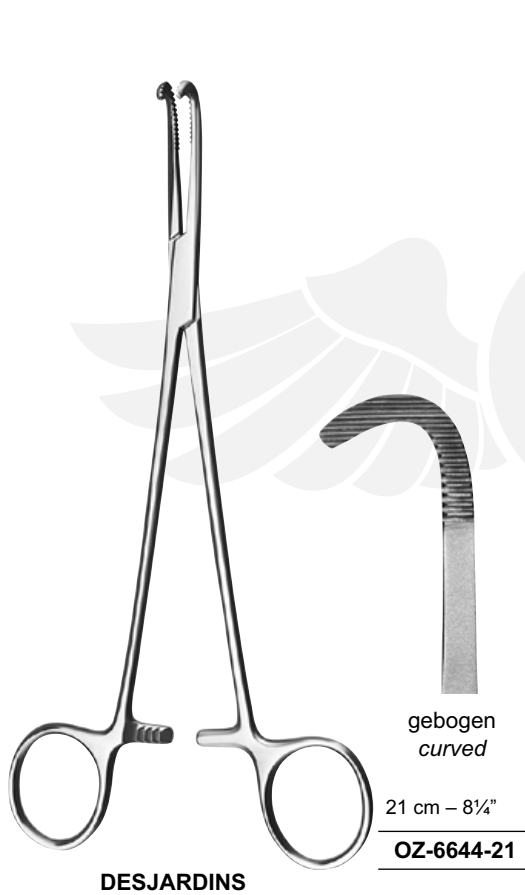

Gallenkanal Instrumente Gall Duct Instruments



BAKES

Gallengangdilatoren,
biegsam

*Gall duct dilators,
malleable*

mm	30 cm – 11¾"
1	OZ-6665-01
2	OZ-6665-02
3	OZ-6665-03
4	OZ-6665-04
5	OZ-6665-05
6	OZ-6665-06
7	OZ-6665-07
8	OZ-6665-08
9	OZ-6665-09
10	OZ-6665-10
11	OZ-6665-11
12	OZ-6665-12
13	OZ-6665-13

Satz à 9 Stück
OZ-6665-03 – OZ-6665-11

*Set of 9 pieces
OZ-6665-03 – OZ-6665-11*

OZ-6665-00

Satz à 9 Stück
OZ-6665-03 – OZ-6665-11
in Leinentuchtasche

*Set of 9 pieces
OZ-6665-03 – OZ-6665-11
in canvas pocket*

OZ-6665-50

Leinentuchtasche, allein
Canvas pocket, only

OZ-6665-71



DESJARDINS

30 cm – 12"

federnd
elastic



Fig. 1

OZ-6670-01



Fig. 2

OZ-6670-02



Fig. 3

OZ-6670-03



Fig. 4

OZ-6670-04



OZZE MEDICAL & SURGICAL SUPPLIES
TOOLS TO OPERATE

Gallenkanal Instrumente Gall Duct Instruments



biegsam
malleable

LUER-KOERTE
32 cm – 12½"



2,5 mm

OZ-6675-02



3,2 mm

OZ-6675-03



4,2 mm

OZ-6675-04



5,5 mm

OZ-6675-05



6,7 mm

OZ-6675-06



8 mm

OZ-6675-08



11 mm

OZ-6675-11



15 mm

OZ-6675-15



OZZE MEDICAL & SURGICAL SUPPLIES
TOOLS TO OPERATE

Nierenklemmen Kidney Clamps

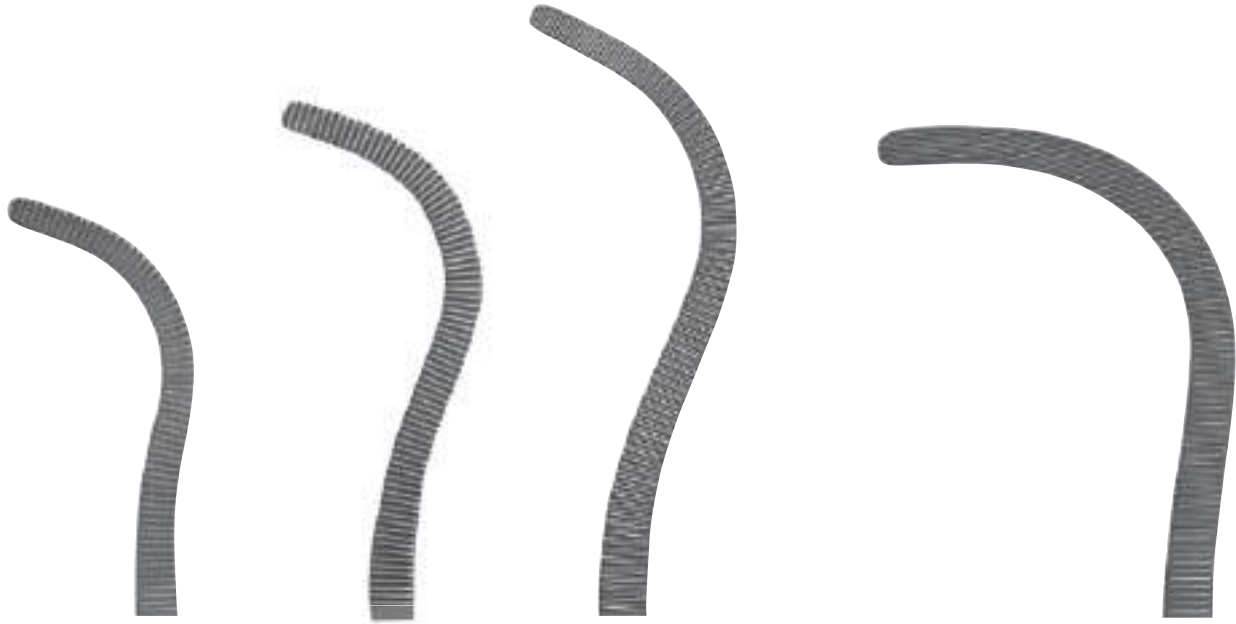

GUYON

20 cm – 8"	22 cm – 8¾"	24 cm – 9½"
OZ-6630-20	OZ-6630-22	OZ-6630-24

GUYON

23 cm – 9"
OZ-6632-23



DE BAKEY Zahnung
DE BAKEY Serration



GUYON / GUYON-ATRAUOZ-



GUYON-ATRAUOZ-

23 cm – 9"	24 cm – 9½"
OZ-6631-23	OZ-6631-24

Nierensteinzangen Kidney Stone Forceps

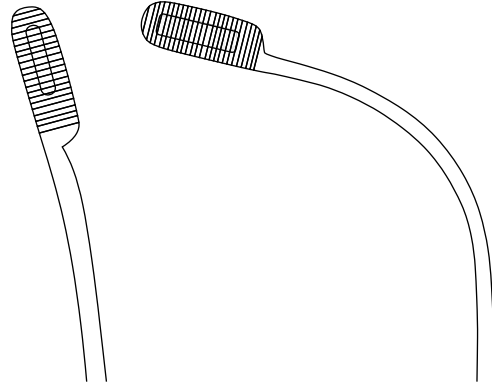

gebogen
curved

Fig. 1
24 cm – 9½"

Fig. 2
21 cm – 8¼"

OZ-6640-01

OZ-6640-02



RANDALL

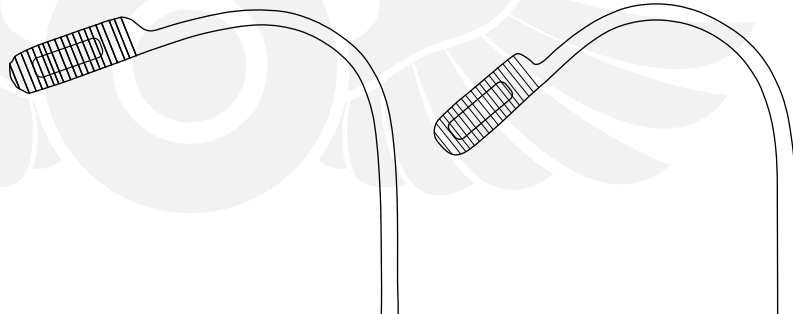

gebogen
curved

Fig. 3
20 cm – 8"

Fig. 4
20 cm – 8"

OZ-6640-03

OZ-6640-04



Blasenwundspreizer Bladder Retractors

Maßangaben für Mittelblätter
und Blätter

1. Zahl = Länge
2. Zahl = Breite

Dimensions for central blades

*2nd number = width
1st number = length*

Mittelblatt

Beispiel: 95 x 22 mm

Central blade

Example: 95 x 22 mm

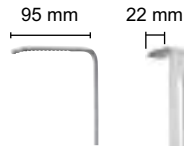

Blätter

Beispiel: 60 x 25 mm

Blades

Example: 60 x 25 mm

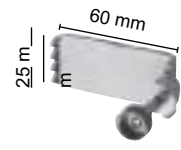

Blasenwundspreizer komplett, bestehend aus: <i>Bladder retractor complete, consisting of:</i>	OZ-6702-00
--	-------------------

Sperrer allein
Retractor only

1 Paar Blätter 57 x 25 mm
1 pair of blades 57 x 25 mm

1 Paar Blätter 80 x 25 mm (max. Spreizweite 120 mm)
1 pair of blades, 80 x 25 mm (max. spread 120 mm)

1 Mittelblatt, 110 x 45 mm
1 Central blade, 110 x 45 mm





Blasenwundspreizer Bladder Retractors

Maßangaben für Mittelblätter
und Blätter

- 1. Zahl = Länge
- 2. Zahl = Breite

Dimensions for central blades

and blades
2nd number = width
1st number = length

Mittelblatt

Beispiel: 95 x 22 mm

Central blade

Example: 95 x 22 mm

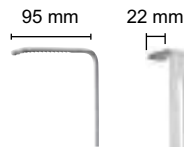

Blätter

Beispiel: 60 x 25 mm

Blades

Example: 60 x 25 mm

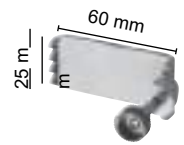

LEGUEU

Blasenwundspreizer komplett, bestehend aus:
Bladder retractor complete, consisting of:

OZ-6703-00

Sperrer allein
Retractor only

- 1 Paar Blätter 62 x 30 mm (max. Spreizweite 70 mm)
- 1 pair of blades 62 x 30 mm (max. spread 70 mm)
- 1 Mittelblatt, 85 x 31 mm
- 1 Central blade, 85 x 31 mm

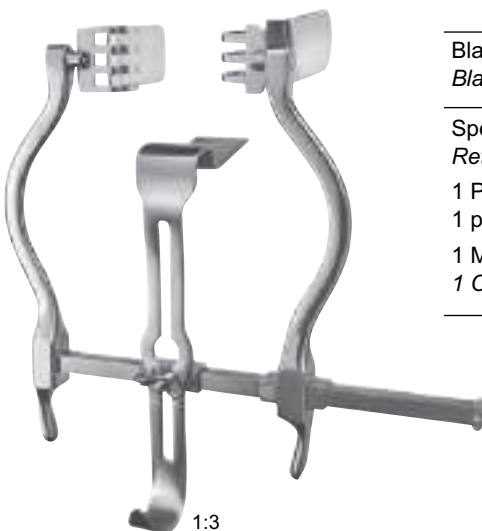

1:3
JUDD-MASSON

Blasenwundspreizer komplett, bestehend aus:
Bladder retractor complete, consisting of:

OZ-6706-00

Sperrer allein
Retractor only

- 1 Paar Blätter 67 x 25 mm (max. Spreizweite 120 mm)
- 1 pair of blades 67 x 25 mm (max. spread 120 mm)
- 1 Mittelblatt, 75 x 25 mm
- 1 Central blade, 75 x 25 mm



OZZE MEDICAL & SURGICAL SUPPLIES
TOOLS TO OPERATE

Urologie-Instrumente
Urology Instruments



12 mm

21 cm – 8¼"
OZ-6690-21

YOUNG



38 mm

22 cm – 8¾"
OZ-6691-22

YOUNG

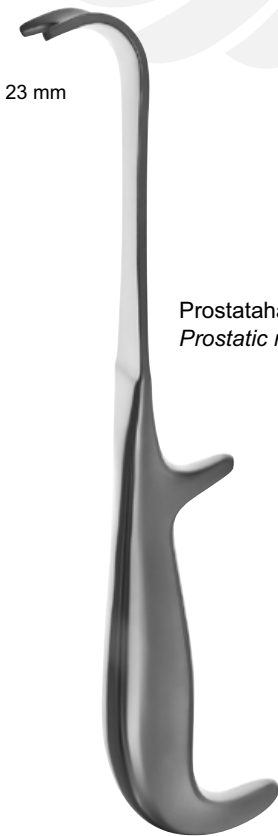

23 mm

Prostatahaken
Prostatic retractor

21 cm – 8¼"
OZ-6692-22

YOUNG

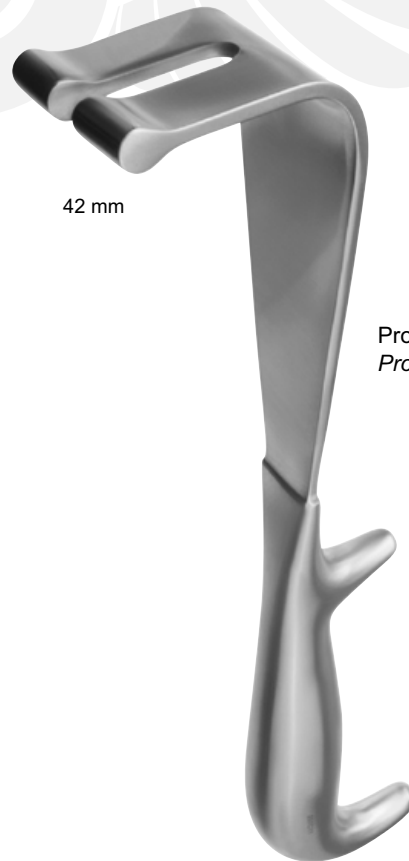

42 mm

Prostatahaken
Prostatic retractor

22 cm – 8¾"
OZ-6693-22

YOUNG

Urologie-Instrumente Urology Instruments

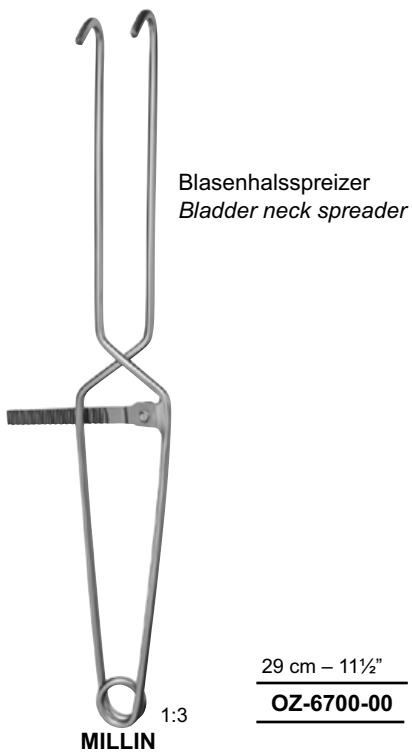



Urethrale Bougies, gebogen
Urethral bougies, curved

Fr. / Charr.	Ø mm	Bèniqùè	27 cm – 10½"
8	2⅔	–	OZ-6710-08
10	3⅓	20	OZ-6710-10
12	4	24	OZ-6710-12
14	4⅔	28	OZ-6710-14
16	5⅓	32	OZ-6710-16
18	6	36	OZ-6710-18
20	6⅔	40	OZ-6710-20
22	7⅓	44	OZ-6710-22
24	8	48	OZ-6710-24
26	8⅔	52	OZ-6710-26
28	9⅓	56	OZ-6710-28
30	10	60	OZ-6710-30
32	10⅔	–	OZ-6710-32
34	10⅔	–	OZ-6710-34
36	12	–	OZ-6710-36

Satz à 6 Stück Fr. / Charr. 14-24
in Segeltuchtasche

Set of 6 pieces Fr. / Charr. 14-24
in canvas pocket

OZ-6710-51

Satz à 12 Stück Fr. / Charr. 8-24
in Segeltuchtasche

Set of 12 pieces Fr. / Charr. 8-24
in canvas pocket

OZ-6710-61

1:3
VAN BURREN



Metalkatheter für Männer,
gebogen
*Metal catheters for men,
curved*

Fr. / Charr.	Ø mm	29 cm – 11½"
8	2⅔	OZ-6715-08
10	3⅓	OZ-6715-10
12	4	OZ-6715-12
14	4⅔	OZ-6715-14



Metalkatheter für Frauen,
gebogen
*Metal catheters for women,
curved*

Fr. / Charr.	Ø mm	16 cm – 6¼"
8	3⅓	OZ-6716-08
10	3⅓	OZ-6716-10
12	4	OZ-6716-12
14	4⅔	OZ-6716-14
16	5⅓	OZ-6716-16
18	6	OZ-6716-18

Urologie-Instrumente Urology Instruments

Katheter-Einführungsinstrument
Catheter guide



39 cm – 15½"
OZ-6718-39

1:3
GUYON

Katheter-Einführungsinstrument
Catheter guide



35 cm – 13¾"
OZ-6719-35

1:3
GUYON

Beschneidungsinstrument
Circumcision instrument



7,5 cm – 3"
OZ-6723-01

MOGEN

Beschneidungsinstrument
Circumcision instrument



GOMCO

8 mm	OZ-6725-08
10 mm	OZ-6725-11
13 mm	OZ-6725-13
16 mm	OZ-6725-16
21 mm	OZ-6725-21
26 mm	OZ-6725-26
32 mm	OZ-6725-32



OZZE MEDICAL & SURGICAL SUPPLIES
TOOLS TO OPERATE

Urologie-Instrumente Urology Instruments

18,5 cm – 7¼"

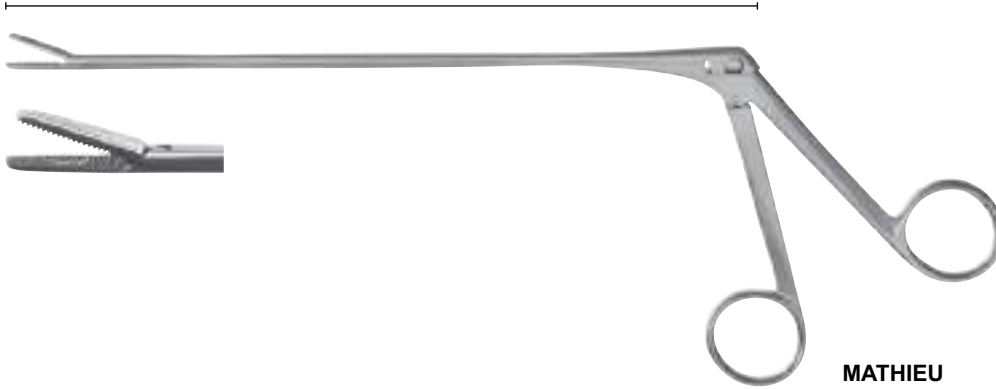

Fremdkörperzange *For-*
eign body forceps

OZ-6727-20

MATHIEU

Penisklemme
Penis clamp

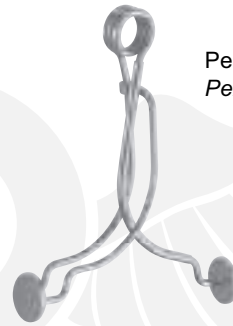

7 cm – 2¾"

OZ-6730-00

STOCKMANN

Sekretlöffel, biegsam
Secretion spoon, malleable



26,5 cm – 10½"

OZ-6735-26

GUTTMANN

Penisklemme
Penis clamp



13 cm – 5"

OZ-6732-00

STRAUSS



©ZZE MEDICAL & SURGICAL SUPPLIES

TOOLS TO OPERATE



©ZZE MEDICAL & SURGICAL SUPPLIES

TOOLS TO OPERATE



NINE

 www.ozzesurgical.com.au

 info@ozzesurgical.com.au



Scheidenspekula	<i>Vaginal Specula</i>	GO 1 - 18, 20 - 21
Scheidenhalter	<i>Vaginal Retractors</i>	GO 19
Uterusdilatoren	<i>Uterine Dilators</i>	GO 22
Endospekula für Cervix	<i>Endospecula for Cervix</i>	GO 23
Uterussonden	<i>Uterine Probes</i>	GO 24
Fasszangen	<i>Grasping Forceps</i>	GO 25
Hakenzangen	<i>Uterine Tenaculum Forceps</i>	GO 26 - 32
Polypen- und Ovarienzangen	<i>Polypus- and Ovary Forceps</i>	GO 33 - 34
Uterusfasszangen	<i>Uterine Elevating Forceps</i>	GO 36 - 37
Biopsieinstrumente	<i>Biopsy Instruments</i>	GO 37, 44
Parametriumklemmen	<i>Parametrium Forceps</i>	GO 38 - 40
Hysterektomieklammern	<i>Hysterectomy Forceps</i>	GO 41 - 42
Vaginalklemmen	<i>Vaginal Forceps</i>	GO 43
Biopsie Küretten	<i>Biopsy Curettes</i>	GO 45
Biopsie Zangen	<i>Biopsy Forceps</i>	GO 46 - 51
Uterus Biopsie Zangen	<i>Uterine Biopsy Forceps</i>	GO 52 - 56
Uteruslöffel	<i>Uterine Scoops</i>	GO 54
Uterusküretten	<i>Uterine Curettes</i>	GO 55 - 57
Biopsie- und Absaugküretten	<i>Biopsy and Aspirating Curettes</i>	GO 58
Salpingograph	<i>Salpingograph</i>	GO 59 - 60
Geburtshilfe	<i>Obstetrics</i>	GO 61 - 62
Geburtszangen	<i>Obstetrical Forceps</i>	GO 63 - 65
Abortuszangen	<i>Ovum Forceps</i>	GO 66
Abortus- und Plazentazangen	<i>Ovum and Placenta Forceps</i>	GO 67
Uterusklemmzangen	<i>Uterine Forceps</i>	GO 68

Scheidenspekula Vaginal Specula

MaßscheOZ-für Spekulum
Scheme of dimensions for specula

a	Blattlänge <i>Length of blade</i>
b	Blattbreite <i>Width of blade</i>

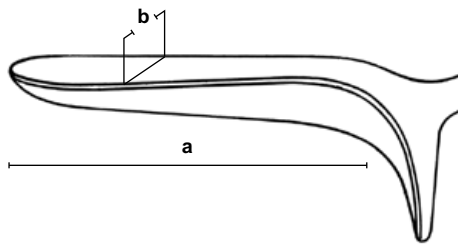

a mm	b mm	für Kinderfor <i>children</i>
65	10	OZ-7020-10

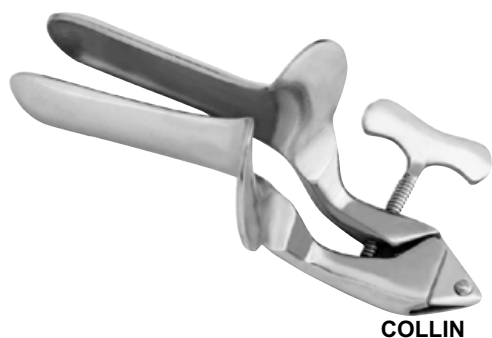

a mm	b mm	für Jungfrauen <i>virgins for</i>
65	20	OZ-7020-11
85	30	OZ-7020-01
100	35	OZ-7020-02
110	40	OZ-7020-03



Scheidenspekula Vaginal Specula

MaßscheOZ-für Spekulum
Scheme of dimensions for specula

a	Blattlänge Length of blade
b	Blattbreite Width of blade

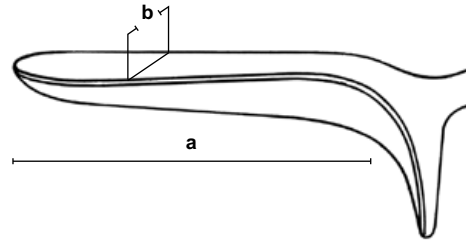

a mm	b mm	für Jungfrauen for virgins
75	17	OZ-7002-00

CUSCO

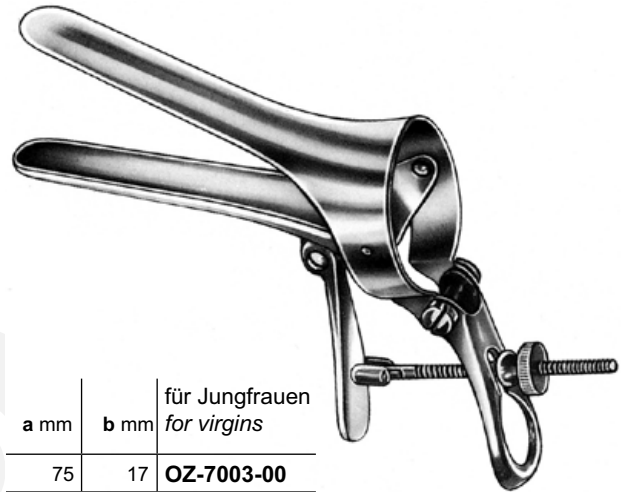

a mm	b mm	für Jungfrauen for virgins
75	17	OZ-7003-00

CUSCO



lang und schmal
long and narrow

a mm	b mm	Schweizer Modell Swiss pattern
90	23-25	OZ-7004-01
100	25-27	OZ-7004-02
110	27-30	OZ-7004-03

CUSCO



Scheidenspekula Vaginal Specula

MaßscheOZ-für Spekulum
Scheme of dimensions for specula

a	Blattlänge Length of blade
b	Blattbreite Width of blade

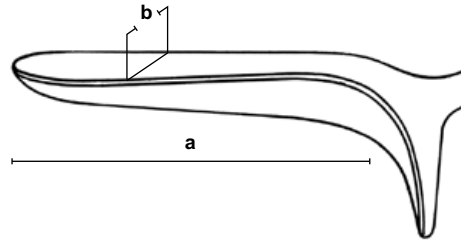

a mm	b mm	
75	32	OZ-7000-01
85	35	OZ-7000-02
100	37	OZ-7000-03



a mm	b mm	
75	32	OZ-7001-01
85	35	OZ-7001-02
100	37	OZ-7001-03



Scheidenspekula Vaginal Specula

MaßscheOZ-für Spekulum
Scheme of dimensions for specula

a	Blattlänge Length of blade
b	Blattbreite Width of blade

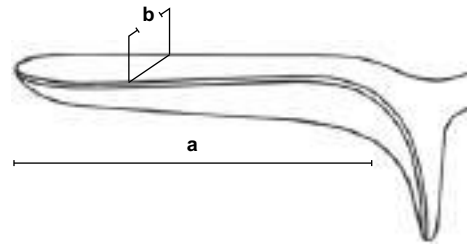

a mm	b mm	
85	33	OZ-7022-01
95	35	OZ-7022-02
115	43	OZ-7022-03

TRELAT



a mm	b mm	abgewinkelt 135° angled 135°
101	35	OZ-7023-01

GRAVE



GRAVE

a mm	b mm	rechts offen, abgewinkelt 90° right side open, angled 90°	rechts offen, abgewinkelt 135° right side open, angled 135°
101	35	OZ-7023-02	OZ-7023-03

Scheidenspekula Vaginal Specula

MaßscheOZ-für Spekulum
Scheme of dimensions for specula

a	Blattlänge Length of blade
b	Blattbreite Width of blade

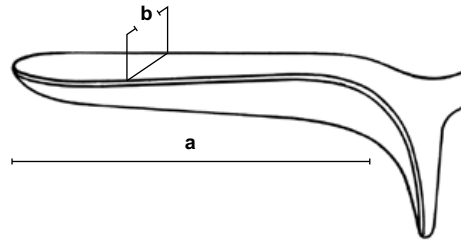

Laser-Spekula
Laser specula



a mm	b mm	
75	20	OZ-7024-01
95	30	OZ-7024-02
115	35	OZ-7024-03

GRAVE

a mm	b mm	
75	20	OZ-7025-01
95	30	OZ-7025-02
115	35	OZ-7025-03
125	35	OZ-7025-05

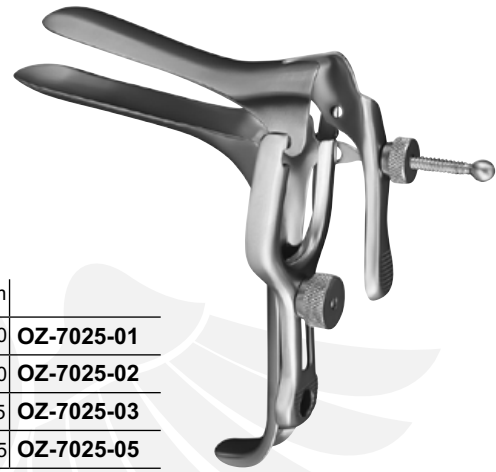

GRAVE

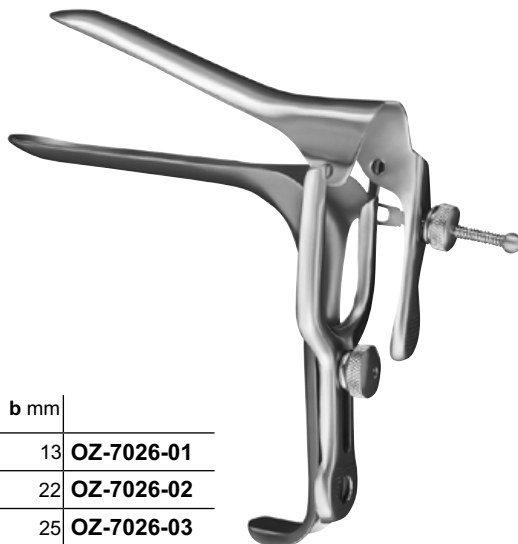

a mm	b mm	
75	13	OZ-7026-01
100	22	OZ-7026-02
120	25	OZ-7026-03

PENDERSON

55 mm

56 x 21 mm



Lateral-Spekulum
Lateral specula

25,5 cm – 10"

1:3

OZ-7040-00



Scheidenspekula, Sets Vaginal Specula, Sets

Maßschema für Spekulum
Scheme of dimensions for specula

a	Blattlänge Length of blade
b	Blattbreite Width of blade

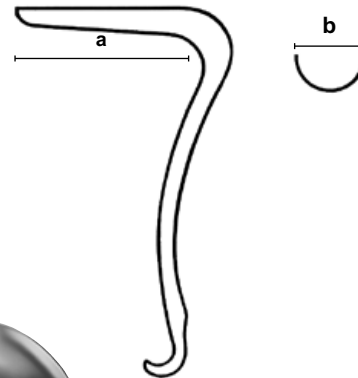

a mm	b mm	
53	32	OZ-7049-01
58	32	OZ-7049-02
70	38	OZ-7049-03



Fig.	a mm	b mm	
1	60	25 + 30	OZ-7050-01
2	70	30 + 35	OZ-7050-02
3	80	35 + 40	OZ-7050-03

Satz
Set
OZ-7050-00

Scheidenspekula, Sets Vaginal Specula, Sets

Maßschema für Spekulum
Scheme of dimensions for specula

a	Blattlänge Length of blade
b	Blattbreite Width of blade

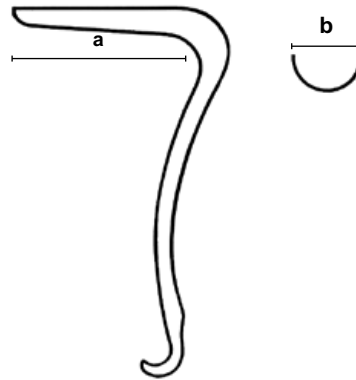

JACKSON

Fig.	a mm	b mm	
1	75	35	OZ-7055-01
2	90	35	OZ-7055-02
3	100	35	OZ-7055-03

Fig.	a mm	b mm	
1	75	38	OZ-7056-01
2	90	38	OZ-7056-02
3	100	38	OZ-7056-03



KALLMORGEN

Scheidenspekulum komplett, bestehend aus: <i>Vaginal specula complete, consisting of:</i>	OZ-7078-01
--	-------------------

1 Spekulum Fig. 1, 70 x 40 mm (OZ-7078-11)
1 Specula fig. 1, 70 x 40 mm (OZ-7078-11)
1 Halter Fig. 1, 70 x 33 mm (OZ-7078-21)
1 Retractor fig. 1, 70 x 33 mm (OZ-7078-21)

Scheidenspekulum komplett, bestehend aus: <i>Vaginal specula complete, consisting of:</i>	OZ-7078-02
--	-------------------

1 Spekulum Fig. 2, 90 x 40 mm (OZ-7078-12)
1 Specula fig. 2, 90 x 40 mm (OZ-7078-12)
1 Halter Fig. 2, 90 x 33 mm (OZ-7078-22)
1 Retractor fig. 2, 90 x 33 mm (OZ-7078-22)

Fig.	a mm	b mm	Spekulum Specula
1	70	40	OZ-7078-11
2	90	40	OZ-7078-12

Fig.	a mm	b mm	Halter Retractor
1	70	33	OZ-7078-21
2	90	33	OZ-7078-22

Scheidenspekula, Sets Vaginal Specula, Sets

Maßschema für Spekulum
Scheme of dimensions for specula

a	Blattlänge Length of blade
b	Blattbreite Width of blade

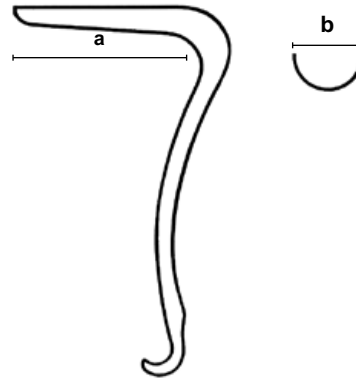

Scheidenspekulum für Kinder komplett, bestehend aus: Vaginal specula for children complete, consisting of:	OZ-7060-00
1 Spekulum, 70 x 15 mm (OZ-7060-30)	
1 Specula, 70 x 15 mm (OZ-7060-30)	
1 Halter, 75 x 10 mm (OZ-7060-40)	
1 Retractor, 75 x 10 mm (OZ-7060-40)	

a mm	b mm	Spekulum Specula
70	15	OZ-7060-30

a mm	b mm	Halter Retractor
75	10	OZ-7060-40

Scheidenspekula, Sets Vaginal Specula, Sets

Maßschema für Spekulum
Scheme of dimensions for specula

a	Blattlänge Length of blade
b	Blattbreite Width of blade

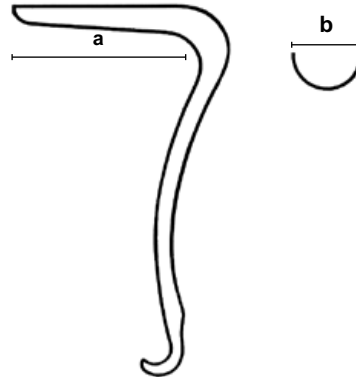

Scheidenspekulum komplett, bestehend aus: Vaginal specula complete, consisting of:	OZ-7060-01
---	-------------------

1 Spekulum Fig. 1, 70 x 27 mm (OZ-7060-11) 1 Specula fig. 1, 70 x 27 mm (OZ-7060-11) 1 Halter Fig. 1, 75 x 23 mm (OZ-7060-21) 1 Retractor fig. 1, 75 x 23 mm (OZ-7060-21)
--

Scheidenspekulum komplett, bestehend aus: Vaginal specula complete, consisting of:	OZ-7060-02
---	-------------------

1 Spekulum Fig. 2, 75 x 30 mm (OZ-7060-12) 1 Specula fig. 2, 75 x 30 mm (OZ-7060-12) 1 Halter Fig. 2, 80 x 26 mm (OZ-7060-22) 1 Retractor fig. 2, 80 x 26 mm (OZ-7060-22)
--

Scheidenspekulum komplett, bestehend aus: Vaginal specula complete, consisting of:	OZ-7060-03
---	-------------------

1 Spekulum Fig. 3, 90 x 36 mm (OZ-7060-13) 1 Specula fig. 3, 90 x 36 mm (OZ-7060-13) 1 Halter Fig. 3, 95 x 32 mm (OZ-7060-23) 1 Retractor fig. 3, 95 x 32 mm (OZ-7060-23)
--

Fig.	a mm	b mm	Spekulum Specula
1	70	27	OZ-7060-11
2	75	30	OZ-7060-12
3	90	36	OZ-7060-13

Fig.	a mm	b mm	Halter Retractor
1	75	23	OZ-7060-21
2	80	26	OZ-7060-22
3	95	32	OZ-7060-23



Scheidenspekula, Sets Vaginal Specula, Sets

Maßschema für Spekulum
Scheme of dimensions for specula

a	Blattlänge Length of blade
b	Blattbreite Width of blade

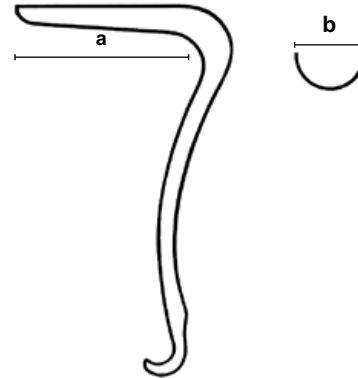

mit konisch verlaufenden
Blättern, für Jungfrauen
with conically shaped
blades, for virgins

KRISTELLER

Scheidenspekulum komplett, bestehend aus: Vaginal specula complete, consisting of:	OZ-7065-01
1 Spekulum Fig. 00, 110 x 18 mm (OZ-7065-11)	
1 Specula fig. 00, 110 x 18 mm (OZ-7065-11)	
1 Halter Fig. 00, 115 x 14 mm (OZ-7065-21)	
1 Retractor fig. 00, 115 x 14 mm (OZ-7065-21)	

Scheidenspekulum komplett, bestehend aus: Vaginal specula complete, consisting of:	OZ-7065-02
1 Spekulum Fig. 0, 110 x 21 mm (OZ-7065-12)	
1 Specula fig. 0, 110 x 21 mm (OZ-7065-12)	
1 Halter Fig. 0, 115 x 17 mm (OZ-7065-22)	
1 Retractor fig. 0, 115 x 17 mm (OZ-7065-22)	

Fig.	a mm	b mm	Spekulum Specula
00	110	18	OZ-7065-11
0	110	21	OZ-7065-12

Fig.	a mm	b mm	Halter Retractor
00	115	14	OZ-7065-21
0	115	17	OZ-7065-22

Scheidenspekula, Sets Vaginal Specula, Sets

Maßschema für Spekulum
Scheme of dimensions for specula

a	Blattlänge Length of blade
b	Blattbreite Width of blade

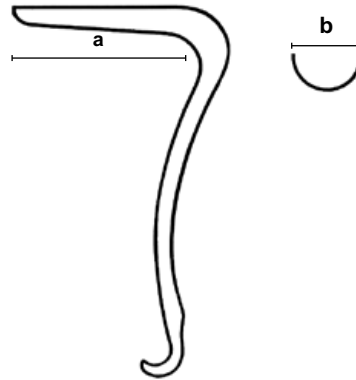

KRISTELLER

Scheidenspekulum komplett, bestehend aus: Vaginal specula complete, consisting of:	OZ-7070-01
1 Spekulum Fig. 1, 110 x 27 mm (OZ-7070-11) 1 Specula fig. 1, 110 x 27 mm (OZ-7070-11) 1 Halter Fig. 1, 115 x 23 mm (OZ-7070-21) 1 Retractor fig. 1, 115 x 23 mm (OZ-7070-21)	
Scheidenspekulum komplett, bestehend aus: Vaginal specula complete, consisting of:	OZ-7070-02
1 Spekulum Fig. 2, 110 x 30 mm (OZ-7070-12) 1 Specula fig. 2, 110 x 30 mm (OZ-7070-12) 1 Halter Fig. 2, 115 x 26 mm (OZ-7070-22) 1 Retractor fig. 2, 115 x 26 mm (OZ-7070-22)	
Scheidenspekulum komplett, bestehend aus: Vaginal specula complete, consisting of:	OZ-7070-03
1 Spekulum Fig. 3, 110 x 36 mm (OZ-7070-13) 1 Specula fig. 3, 110 x 36 mm (OZ-7070-13) 1 Halter Fig. 3, 115 x 32 mm (OZ-7070-23) 1 Retractor fig. 3, 115 x 32 mm (OZ-7070-23)	

Fig.	a mm	b mm	Spekulum Specula
1	110	27	OZ-7070-11
2	110	30	OZ-7070-12
3	110	36	OZ-7070-13

Fig.	a mm	b mm	Halter Retractor
1	115	23	OZ-7070-21
2	115	26	OZ-7070-22
3	115	32	OZ-7070-23



Scheidenspekula, Sets Vaginal Specula, Sets

Maßschema für Spekulum
Scheme of dimensions for specula

a	Blattlänge Length of blade
b	Blattbreite Width of blade

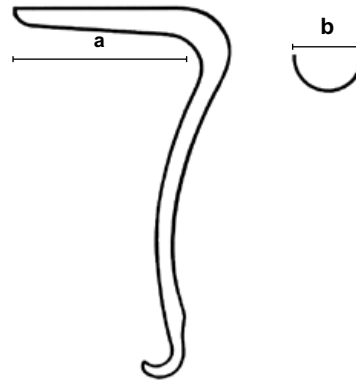

mit abgeflachtem Spekulum
with flattened specula

KRISTELLER

Scheidenspekulum komplett, bestehend aus: Vaginal specula complete, consisting of:	OZ-7072-01
1 Spekulum Fig. 1, 110 x 27 mm (OZ-7072-11)	
1 Specula fig. 1, 110 x 27 mm (OZ-7072-11)	
1 Halter Fig. 1, 115 x 23 mm (OZ-7072-21)	
1 Retractor fig. 1, 115 x 23 mm (OZ-7072-21)	

Scheidenspekulum komplett, bestehend aus: Vaginal specula complete, consisting of:	OZ-7072-02
1 Spekulum Fig. 2, 110 x 30 mm (OZ-7072-12)	
1 Specula fig. 2, 110 x 30 mm (OZ-7072-12)	
1 Halter Fig. 2, 115 x 26 mm (OZ-7072-22)	
1 Retractor fig. 2, 115 x 26 mm (OZ-7072-22)	

Scheidenspekulum komplett, bestehend aus: Vaginal specula complete, consisting of:	OZ-7072-03
1 Spekulum Fig. 3, 110 x 36 mm (OZ-7072-13)	
1 Specula fig. 3, 110 x 36 mm (OZ-7072-13)	
1 Halter Fig. 3, 115 x 32 mm (OZ-7072-23)	
1 Retractor fig. 3, 115 x 32 mm (OZ-7072-23)	

Fig.	a mm	b mm	Spekulum Specula
1	110	27	OZ-7072-11
2	110	30	OZ-7072-12
3	110	36	OZ-7072-13

Fig.	a mm	b mm	Halter Retractor
1	115	23	OZ-7072-21
2	115	26	OZ-7072-22
3	115	32	OZ-7072-23

Scheidenspekula Vaginal Specula

Maßschema für Spekulum
Scheme of dimensions for specula

a	Blattlänge Length of blade
b	Blattbreite Width of blade

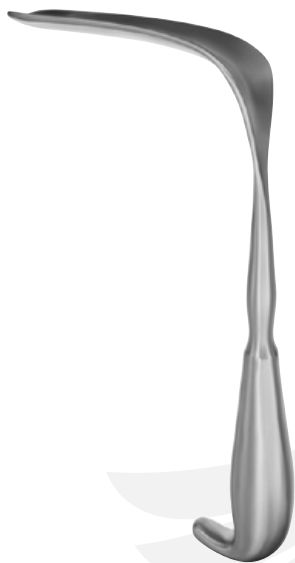
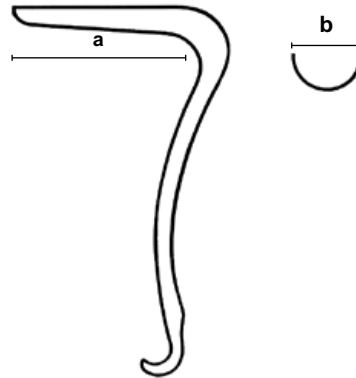

MATZENAUER

a mm	b mm		a mm	b mm	
100	20	OZ-7073-01	130	20	OZ-7073-11
100	25	OZ-7073-02	130	25	OZ-7073-12
100	30	OZ-7073-03	130	30	OZ-7073-13
100	35	OZ-7073-04	130	35	OZ-7073-14
100	40	OZ-7073-05	130	40	OZ-7073-15



BRAUN

a mm	b mm	18 cm – 7"
56	13	OZ-7074-00



BRAUN

a mm	b mm	18 cm – 7"
60	10	OZ-7075-00



Scheidenspekula Vaginal Specula

Maßschema für Spekulum
Scheme of dimensions for specula

a	Blattlänge Length of blade
b	Blattbreite Width of blade

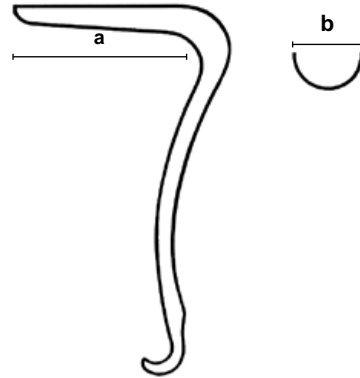

a mm	b mm	19 cm – 7½"
85	17	OZ-7077-00

Scheidenspekula Vaginal Specula

Maßschema für Spekulum
Scheme of dimensions for specula

a	Blattlänge Length of blade
b	Blattbreite Width of blade

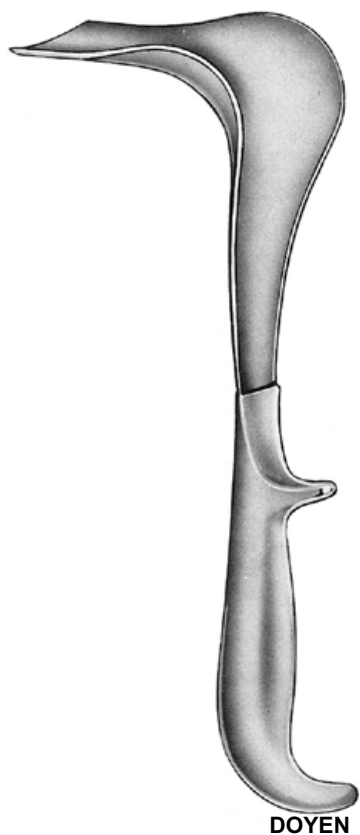
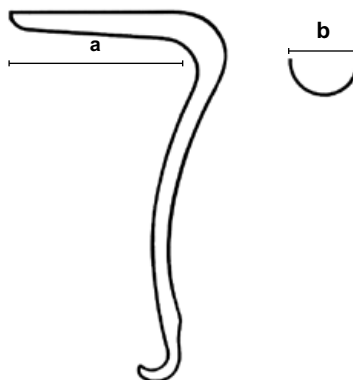
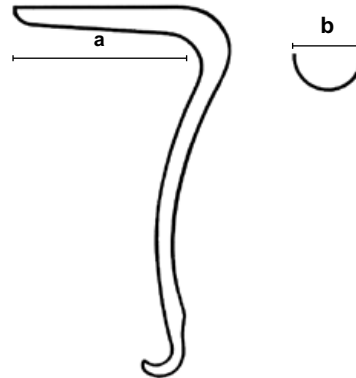

Fig.	a mm	b mm	
1	75	45	OZ-7080-11
2	90	45	OZ-7080-12
3	110	45	OZ-7080-13

Scheidenspekula Vaginal Specula

Maßschema für Spekulum
Scheme of dimensions for specula

a	Blattlänge Length of blade
b	Blattbreite Width of blade



DOYEN

24 cm – 9½"

Fig.	a mm	b mm	leicht hohl/lightly-concave -
1	55	35	OZ-7080-01
2	85	35	OZ-7080-02
3	115	35	OZ-7080-03

1	55	45	OZ-7081-01
2	85	45	OZ-7081-02
3	115	45	OZ-7081-03
4	160	45	OZ-7081-04

1	55	60	OZ-7082-01
2	85	60	OZ-7082-02
3	115	60	OZ-7082-03
4	160	60	OZ-7082-04

Scheidenspekula Vaginal Specula

Maßschema für Spekulum
Scheme of dimensions for specula

a	Blattlänge Length of blade
b	Blattbreite Width of blade

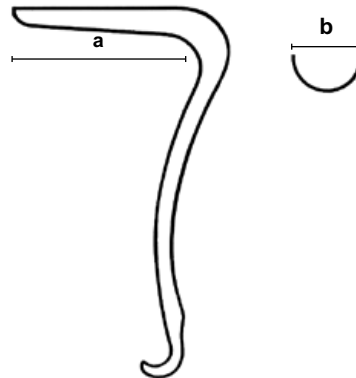

DOYEN

24 cm – 9½"

Fig.	a mm	b mm	halbhohlmedi um-concave-
1	55	35	OZ-7083-01
2	85	35	OZ-7083-02
3	115	35	OZ-7083-03

1	55	45	OZ-7084-01
2	85	45	OZ-7084-02
3	115	45	OZ-7084-03

1	55	60	OZ-7085-01
2	85	60	OZ-7085-02
3	115	60	OZ-7085-03

Scheidenspekula Vaginal Specula

Maßschema für Spekulum
Scheme of dimensions for specula

a	Blattlänge Length of blade
b	Blattbreite Width of blade

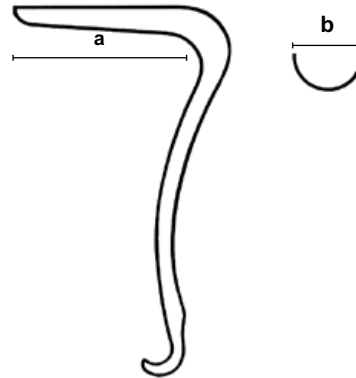

BREISKY

a mm	b mm	
100	20	OZ-7090-20
100	25	OZ-7090-25
100	30	OZ-7090-30
100	35	OZ-7090-35
100	40	OZ-7090-40
130	20	OZ-7091-20
130	25	OZ-7091-25
130	30	OZ-7091-30
130	35	OZ-7091-35
130	40	OZ-7091-40
160	20	OZ-7092-20
160	25	OZ-7092-25
160	30	OZ-7092-30
160	35	OZ-7092-35
160	40	OZ-7092-40
180	20	OZ-7093-20
180	25	OZ-7093-25
180	30	OZ-7093-30
180	35	OZ-7093-35
180	40	OZ-7093-40

Scheidenhalter Vaginal Retractors

Maßschema für Spekulum
Scheme of dimensions for specula

a	Blattlänge Length of blade
b	Blattbreite Width of blade

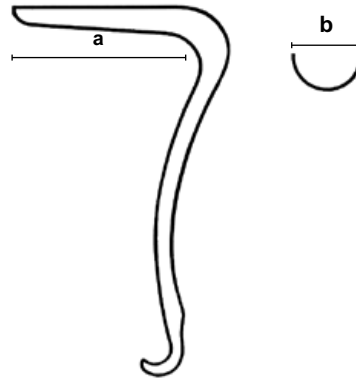

seitliches Spekulum
lateral speculum

DOYEN

a mm	b mm	25 cm – 10"
60	30	OZ-7086-01
70	30	OZ-7086-02
80	30	OZ-7086-25

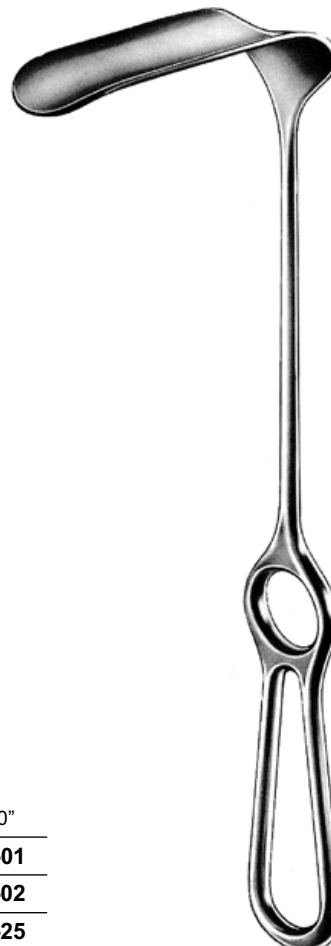

HÖSEL

	25 cm – 10"
60 x 20 mm	OZ-4542-01
80 x 30 mm	OZ-4542-02
100 x 30 mm	OZ-4542-03
120 x 30 mm	OZ-4542-04
140 x 30 mm	OZ-4542-05
140 x 40 mm	OZ-4542-06



Scheidenspekula Vaginal Specula

Maßschema für Spekulum
Scheme of dimensions for specula

a	Blattlänge Length of blade
b	Blattbreite Width of blade

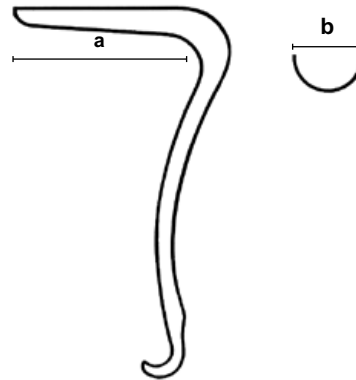

mit abnehmbarem Gewicht
with detachable weight

AUVARDA

1:3

a mm	b mm	
80	38	OZ-7088-00
105	42	OZ-7088-10



mit festem Gewicht
with fixed weight

AUVARD

1:3

a mm	b mm	
70	38	OZ-7088-51
102	45	OZ-7088-52

Scheidenspekula Vaginal Specula

Maßschema für Spekulum
Scheme of dimensions for specula

a	Blattlänge Length of blade
b	Blattbreite Width of blade

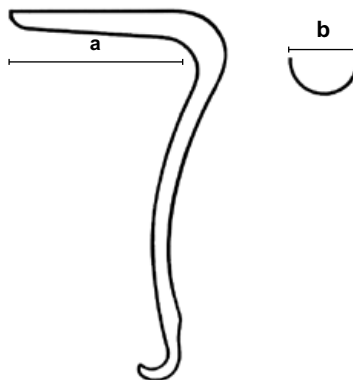

Scheidenspekulum komplett, bestehend aus: Vaginal specula complete, consisting of:	OZ-7095-00
---	-------------------

1 Griff (OZ-7095-14) 1 Handle (OZ-7095-14)
1 Gewicht, leicht, 400 g (OZ-7095-10) 1 Weight, light, 400 g (OZ-7095-10)
5 Blätter (1 Stück) (OZ-7095-01, -02, -03, -04, -05) 5 Blades (1 piece) (OZ-7095-01, -02, -03, -04, -05)



SCHERBAK



Griff
Handle
OZ-7095-14

Gewicht, leicht, 400 g
Weight, light, 400 g
OZ-7095-10

Gewicht, schwer, 800 g
Weight, heavy, 800 g
OZ-7095-12





Uterusdilatoren Uterine Dilators



HEGAR

Ø mm	
1	OZ-7100-01
2	OZ-7100-02
3	OZ-7100-03
4	OZ-7100-04
5	OZ-7100-05
6	OZ-7100-06
7	OZ-7100-07
8	OZ-7100-08
9	OZ-7100-09
10	OZ-7100-10
11	OZ-7100-11
12	OZ-7100-12
13	OZ-7100-13
14	OZ-7100-14
15	OZ-7100-15

Ø mm	
16	OZ-7100-16
17	OZ-7100-17
18	OZ-7100-18
19	OZ-7100-19
20	OZ-7100-20
21	OZ-7100-21
22	OZ-7100-22
23	OZ-7100-23
24	OZ-7100-24
25	OZ-7100-25
26	OZ-7100-26
27	OZ-7100-27
28	OZ-7100-28
29	OZ-7100-29
30	OZ-7100-30

Ø mm	
1,5	OZ-7101-01
2,5	OZ-7101-02
3,5	OZ-7101-03
4,5	OZ-7101-04
5,5	OZ-7101-05
6,5	OZ-7101-06
7,5	OZ-7101-07
8,5	OZ-7101-08
9,5	OZ-7101-09
10,5	OZ-7101-10
11,5	OZ-7101-11
12,5	OZ-7101-12
13,5	OZ-7101-13
14,5	OZ-7101-14
15,5	OZ-7101-15
16,5	OZ-7101-16
17,5	OZ-7101-17
18,5	OZ-7101-18
19,5	OZ-7101-19



HEGAR

Ø mm	
1 / 2	OZ-7102-02
3 / 4	OZ-7102-04
5 / 6	OZ-7102-06
7 / 8	OZ-7102-08
9 / 10	OZ-7102-10
11 / 12	OZ-7102-12
13 / 14	OZ-7102-14
15 / 16	OZ-7102-16
17 / 18	OZ-7102-18
19 / 20	OZ-7102-20
21 / 22	OZ-7102-22
23 / 24	OZ-7102-24
25 / 26	OZ-7102-26

Stück per Satz Pieces per set	Satz Set
8 St. / pcs. (3 / 4 – 17 / 18 mm)	OZ-7102-30
13 St. / pcs. (1 / 2 – 25 / 26 mm)	OZ-7102-40



8 Stück (3 / 4 – 17 / 18 mm) in auskochbarer Rolltasche	OZ-7102-50
8 pieces (3 / 4 – 17 / 18 mm) in boilable canvas roll	
Rolltasche, allein Canvas roll, only	OZ-7102-51



OZZE MEDICAL & SURGICAL SUPPLIES
TOOLS TO OPERATE

Endospekula für Cervix Endospecula for Cervix



34 cm – 13½"
OZ-7120-34

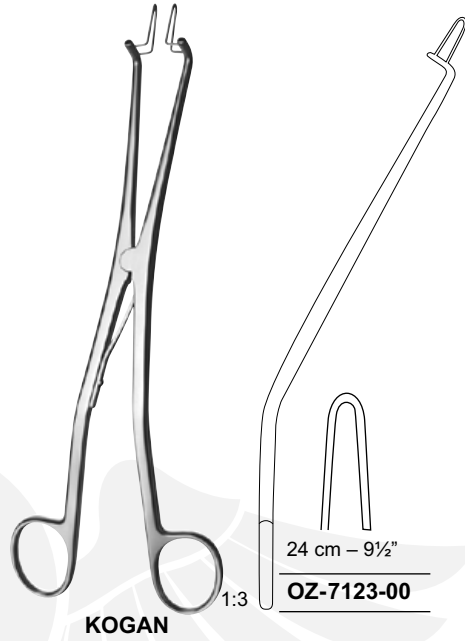

24 cm – 9½"
OZ-7123-00

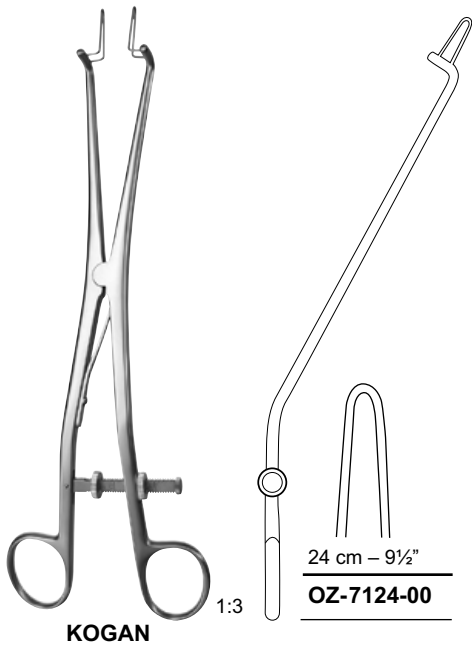

24 cm – 9½"
OZ-7124-00

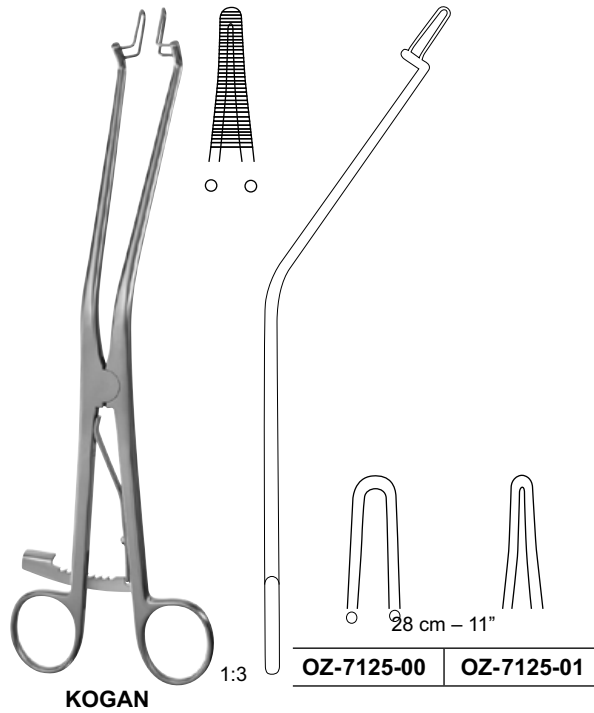

28 cm – 11"
OZ-7125-00 | **OZ-7125-01**

Uterussonden Uterine Probes

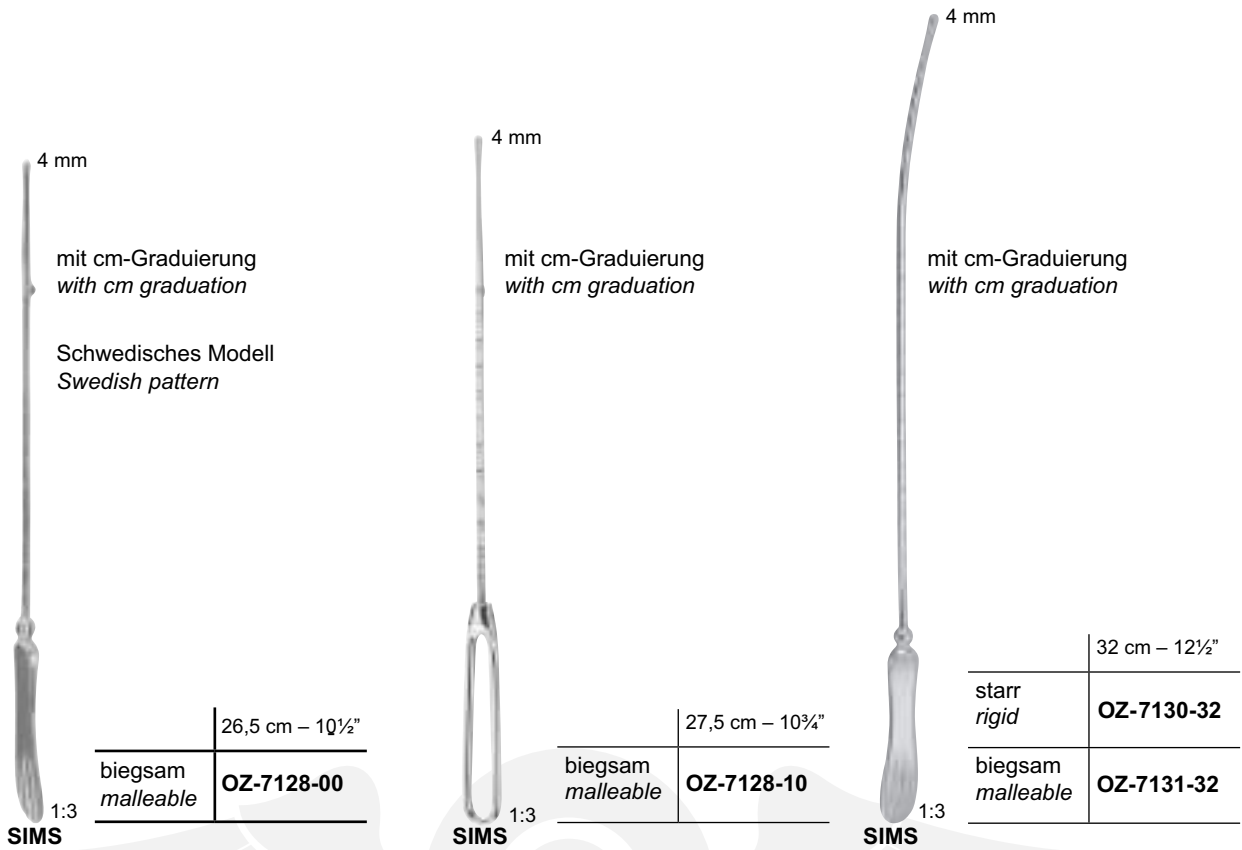

4 mm

mit cm-Graduierung
with cm graduation

Schwedisches Modell
Swedish pattern

	26,5 cm – 10½"
biegsam <i>malleable</i>	OZ-7128-00

1:3
SIMS

4 mm

mit cm-Graduierung
with cm graduation

	27,5 cm – 10¾"
biegsam <i>malleable</i>	OZ-7128-10

1:3
SIMS

4 mm

mit cm-Graduierung
with cm graduation

	32 cm – 12½"
starr <i>rigid</i>	OZ-7130-32
biegsam <i>malleable</i>	OZ-7131-32

1:3
SIMS

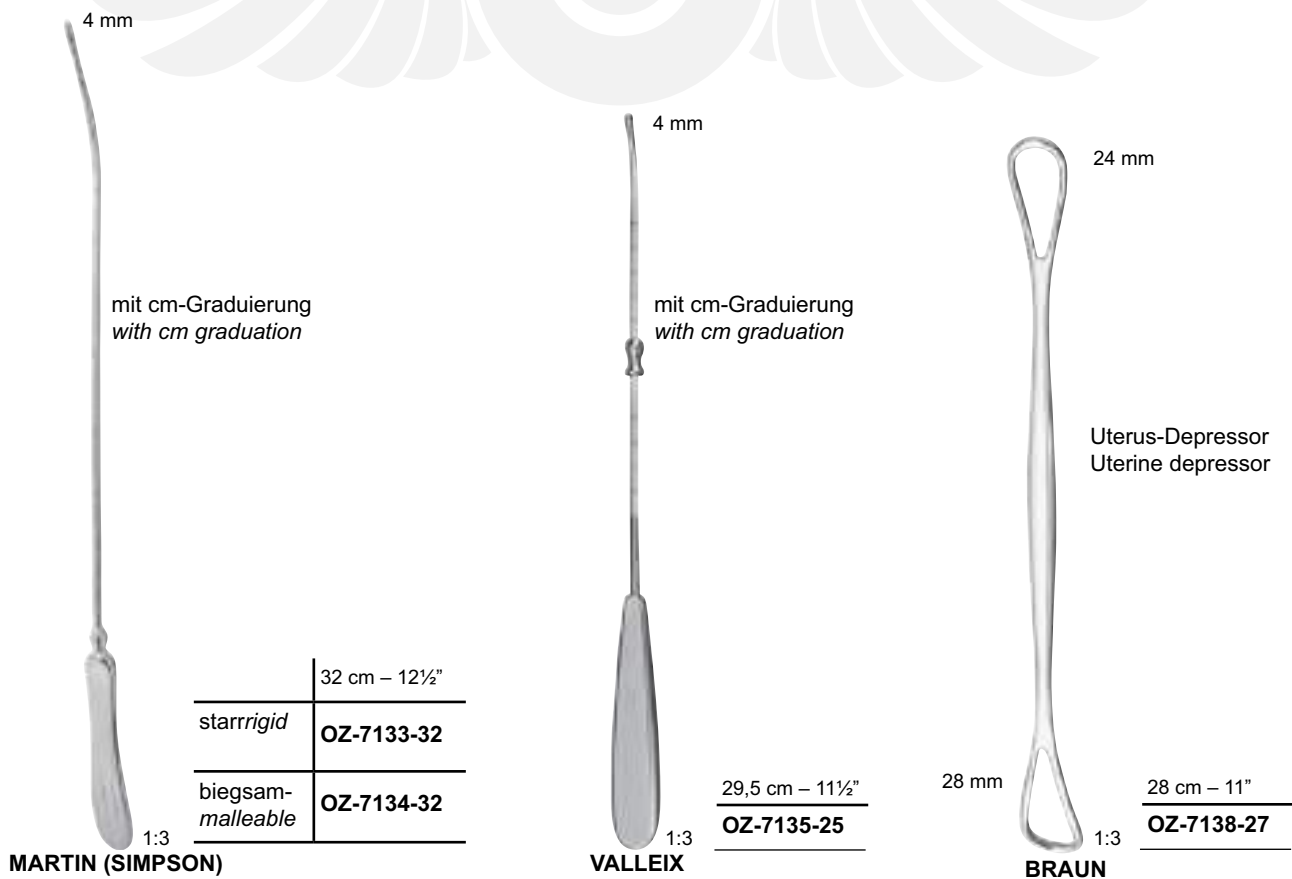

4 mm

mit cm-Graduierung
with cm graduation

	32 cm – 12½"
starr <i>rigid</i>	OZ-7133-32
biegsam <i>malleable</i>	OZ-7134-32

1:3
MARTIN (SIMPSON)

4 mm

mit cm-Graduierung
with cm graduation

	29,5 cm – 11½"
	OZ-7135-25

1:3
VALLEIX

24 mm

Uterus-Depressor
Uterine depressor

	28 cm – 11"
	OZ-7138-27

1:3
BRAUN



OZZE MEDICAL & SURGICAL SUPPLIES
TOOLS TO OPERATE

Fasszangen Grasping Forceps



SCHACKE

23 cm – 9"

OZ-7150-00



27 cm – 10½"

OZ-7284-00

1:3



IUP-Fasszange, fl exible
IUD grasping forceps, fl exible

OZ-7153-00



Hakenzangen Uterine Tenaculum Forceps



KAHN

24,5 cm – 9¾"
OZ-7157-24



MARTIN

27 cm – 10½"
OZ-7158-27

1:3



BARRETT

18 cm – 7"
OZ-7159-03



SCHRÖDER

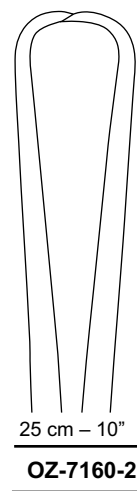

25 cm – 10"
OZ-7160-25

1:3

Hakenzangen

Uterine Tenaculum Forceps

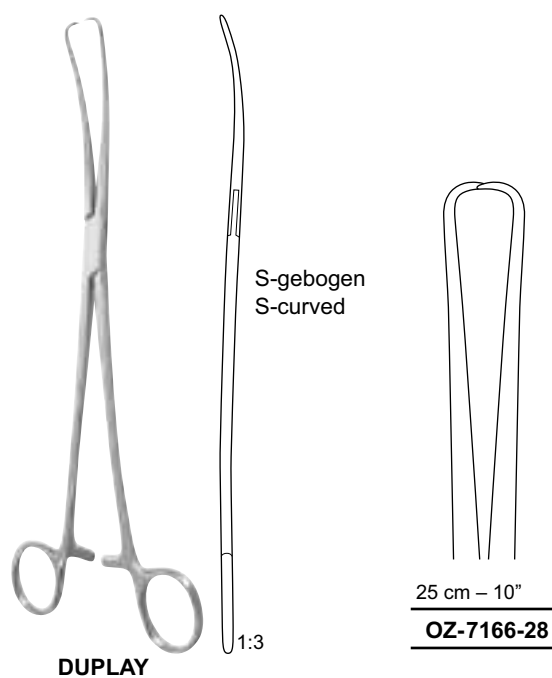
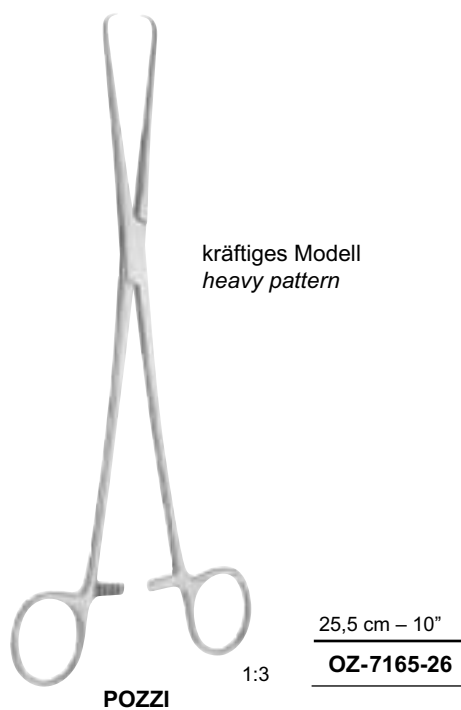



Hakenzangen Uterine Tenaculum Forceps



S-gebogen
S-curved

20 cm – 8"

OZ-7167-20

JARCHO



24 cm – 9½"

OZ-7168-24

1:3

SKENE



Amniotom für das
Amnionmembran
*Amniotome for the
amniotic membrane*

26 cm – 10¼"

OZ-7170-26

1:3
BEACHAM

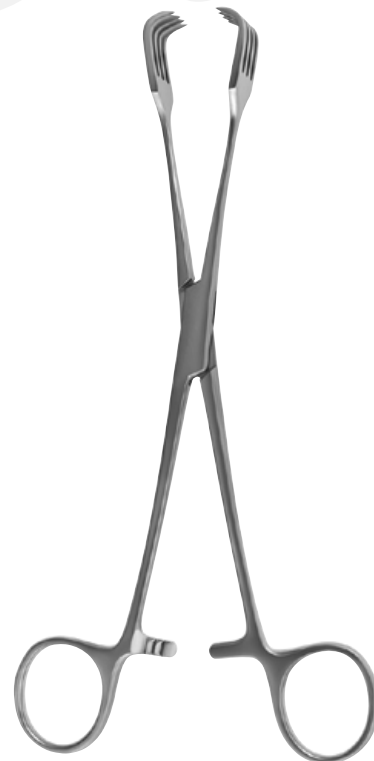

11 mm

20,5 cm – 8"

OZ-7175-20

CZERNY



OZZE MEDICAL & SURGICAL SUPPLIES
TOOLS TO OPERATE

Hakenzangen Uterine Tenaculum Forceps

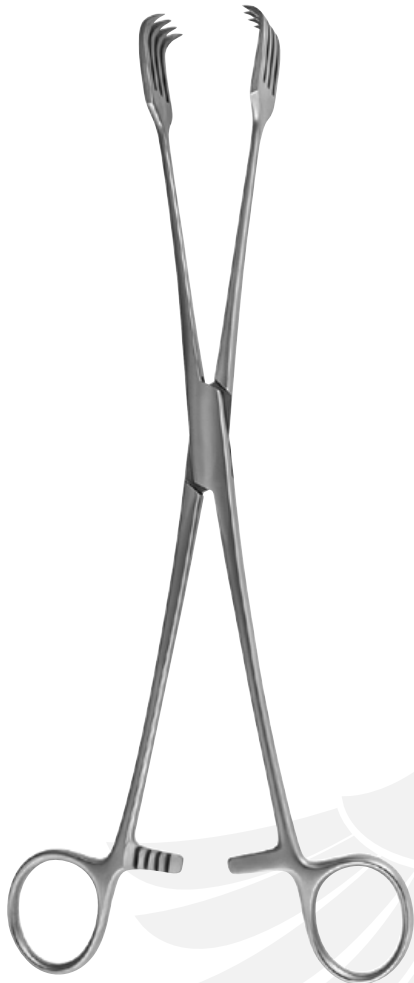

PRATT



26 cm – 10¼"

OZ-7178-26

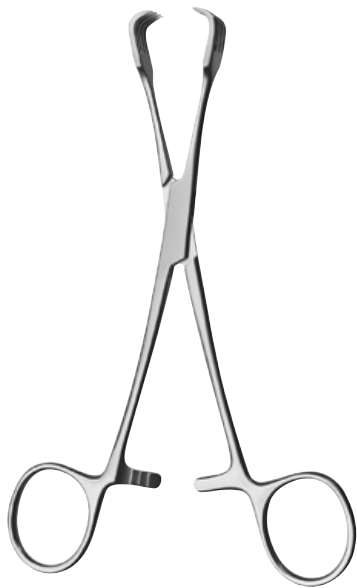

BRAUN



15,5 cm – 6"

OZ-7197-16



Hakenzangen Uterine Tenaculum Forceps



2 : 2 Zähne
2 : 2 teeth

SCHRÖDER



gerade
straight

20 cm – 8"	OZ-7180-20
24 cm – 9½"	OZ-7180-24



2 : 2 Zähne
2 : 2 teeth

SCHRÖDER



aufgebogen
curved on flat



seitlich gebogen
curved sideways

20 cm – 8"	OZ-7181-20	OZ-7182-20
24 cm – 9½"	OZ-7181-24	OZ-7182-24



OZZE MEDICAL & SURGICAL SUPPLIES
TOOLS TO OPERATE

Hakenzangen Uterine Tenaculum Forceps



MUSEUX



gerade
straight

21 cm – 8¼"

OZ-7189-20

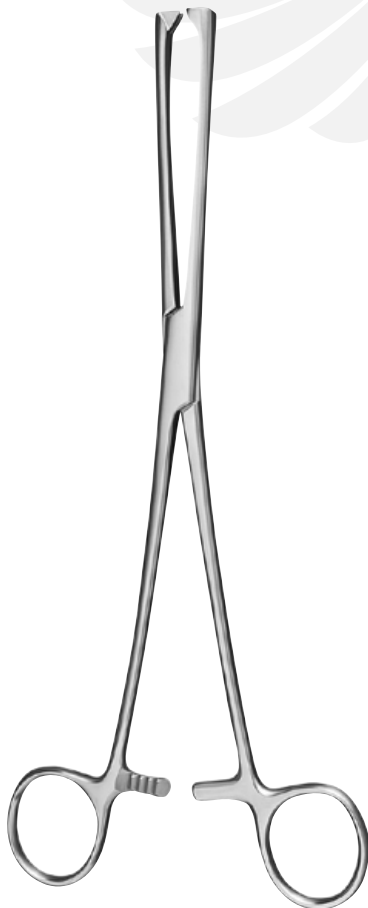

MUSEUX

1:3



gerade
straight

24 cm – 9½"

6 mm	8 mm	10 mm
OZ-7190-06	OZ-7190-08	OZ-7190-10



Hakenzangen Uterine Tenaculum Forceps

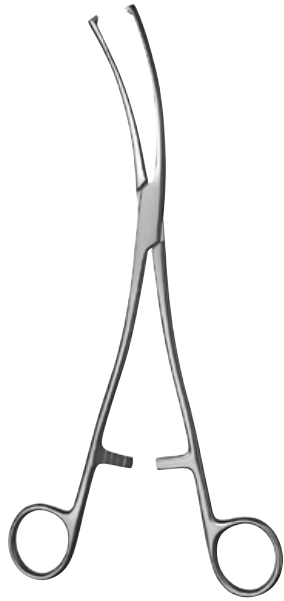

MUSEUX

1:3



seitlich gebogen
curved sideways

24 cm – 9½"

6 mm	8 mm	10 mm
OZ-7191-06	OZ-7191-08	OZ-7191-10

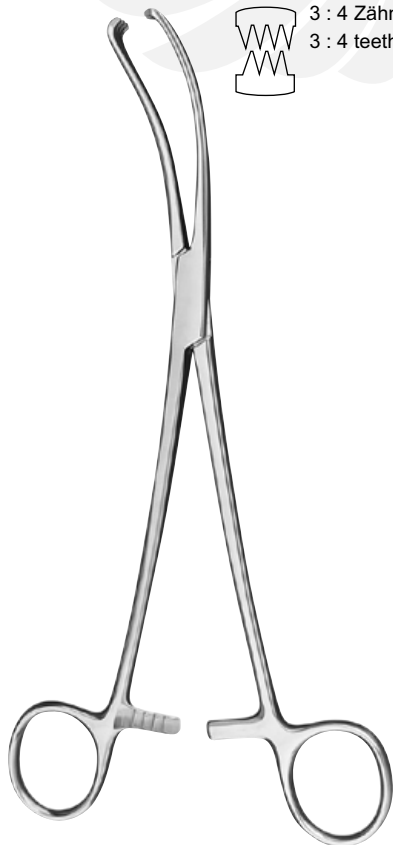

TEALE



3 : 4 Zähne
3 : 4 teeth

seitlich gebogen
curved sideways

23 cm – 9"

OZ-7200-23

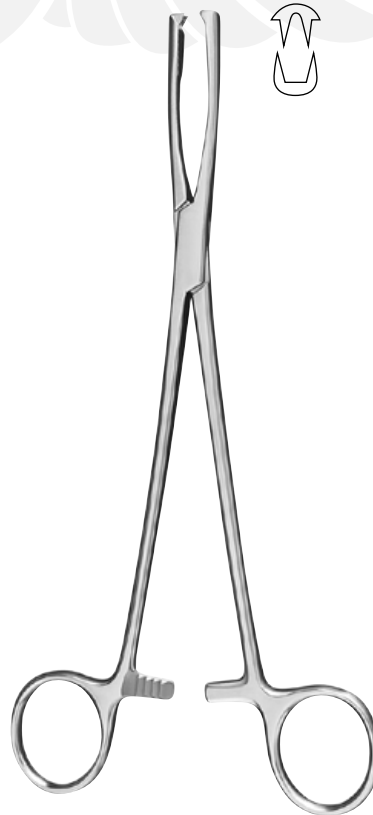

JACOBS



gerade
straight

21 cm – 8¼"

OZ-7210-21



Polypen- und Ovarienzangen Polypus and Ovary Forceps



DE LEE

1:3



gerade
straight

24 cm – 9½"

OZ-7212-24



VAUT

1:3



aufgebogen
curved on flat

26 cm – 10¼"

OZ-7214-26



KELLY

1:3



aufgebogen
curved on flat

32 cm – 12½"

OZ-7215-32



BONNEY

1:3



gerade
straight

24 cm – 9½"

OZ-7216-24



OZZE MEDICAL & SURGICAL SUPPLIES
TOOLS TO OPERATE

Polypen- und Ovarienzangen Polypus and Ovary Forceps



gerade
straight

20 cm – 8"

OZ-6616-20



gerade
straight

25 cm – 10"

OZ-7218-25

HEYWOOD-SMITH

HEYWOOD-SMITH



gerade
straight

27 cm – 10½"

OZ-7219-27

NOTO



Uterusfasszangen Uterine Elevating Forceps



DRATIGUES

1:3

27 cm – 10½"

OZ-7222-27



SOMER

1:3

23 cm – 9"

OZ-7223-23



mit beweglichen Maulteilen
with moveable jaws

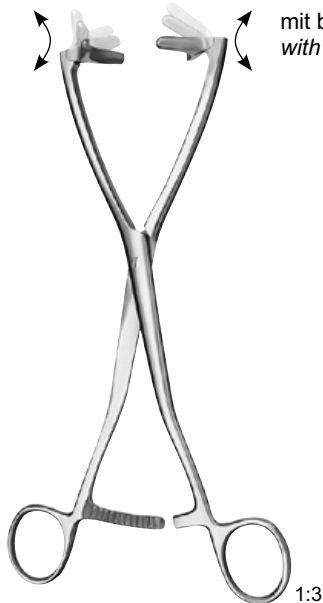

COLLIN

1:3

25 cm – 10"

OZ-7224-25



COLLIN

1:3

28,5 cm – 11¼"

OZ-7225-28

Uterusfazzangen Uterine Elevating Forceps

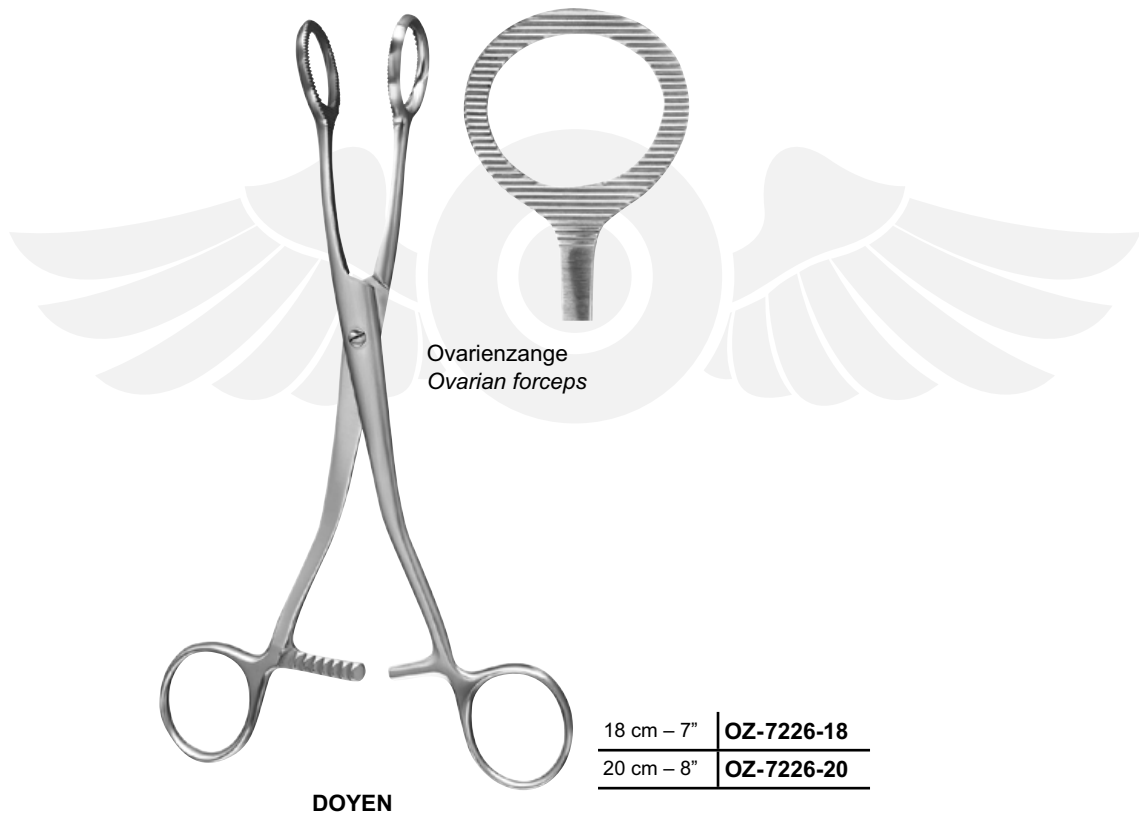



Biopsieinstrumente Biopsy Instruments



Fistelhaken
Fistula hook



scharf
sharp

22 cm – 8¾"

OZ-7230-22

SIMON

Fistelhaken
Fistula hook



scharf
sharp

22 cm – 8¾"

OZ-7231-22

SIMON

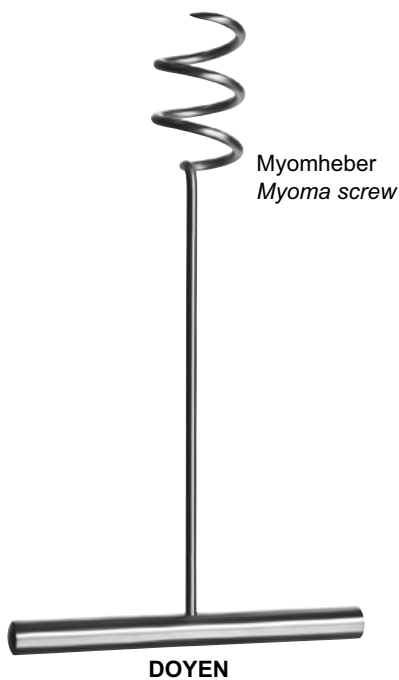

Myomheber
Myoma screw

17 cm – 6¾"

OZ-7239-17

DOYEN

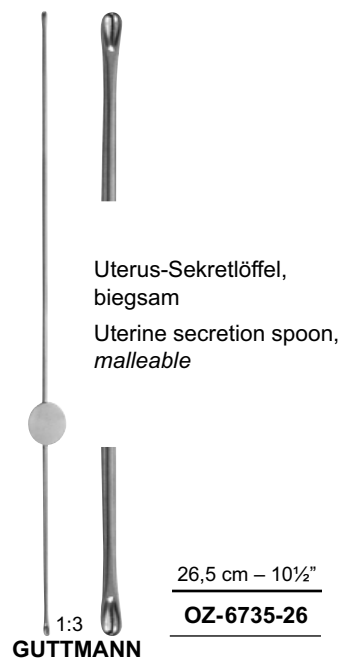

Uterus-Sekretlöffel,
biegsam
Uterine secretion spoon,
malleable

26,5 cm – 10½"

OZ-6735-26

1:3
GUTTMANN



Parametriumklemmen Parametrium Forceps



gerade
straight

22,5 cm – 8¾"

OZ-3383-01



leicht gebogen
slightly curved

22 cm – 8¾"

OZ-3383-02



stark gebogen
strongly curved

21,5 cm – 8½"

OZ-3383-03



gebogen
curved

20,5 cm – 8"

OZ-3383-04



DE BAKEY Zahnung
DE BAKEY Serration



ROGERS



gerade
straight

25 cm – 10"

OZ-3383-51



leicht gebogen
slightly curved

24,5 cm – 9¾"

OZ-3383-52



stark gebogen
strongly curved

24 cm – 9½"

OZ-3383-53



gebogen
curved

23 cm – 9"

OZ-3383-54

Parametriumklemmen Parametrium Forceps

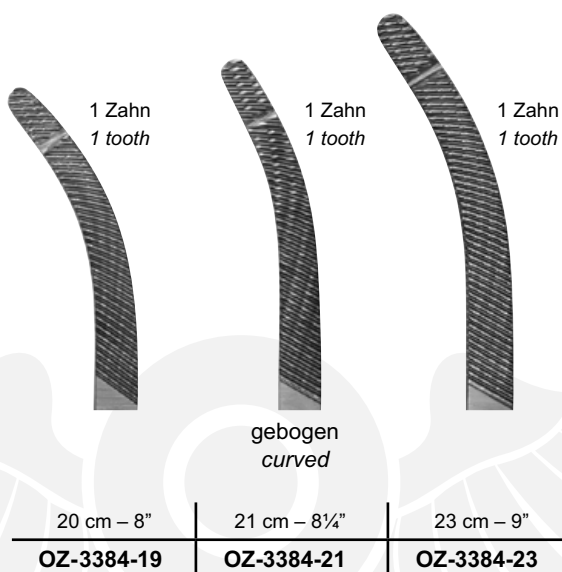

HEANEY

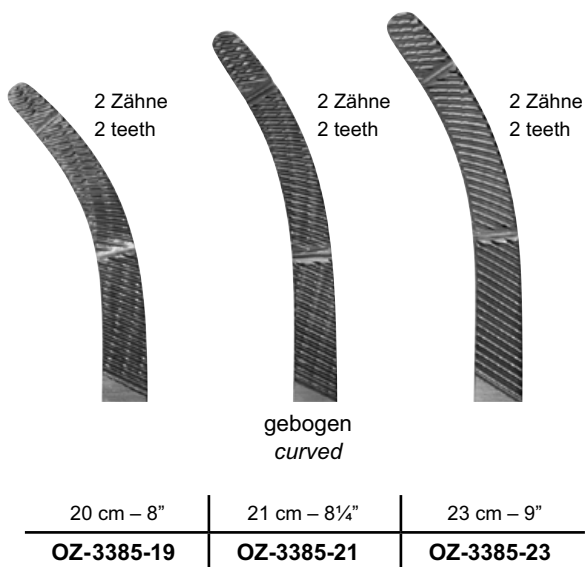

Parametriumklemmen
Parametrium Forceps



HEANEY-SLIM

1 Zahn
1 tooth

gebogen
curved

21 cm – 8¼"

OZ-3384-41



OZZE MEDICAL & SURGICAL SUPPLIES
TOOLS TO OPERATE

Hysterektomieklemmen Hysterectomy Forceps

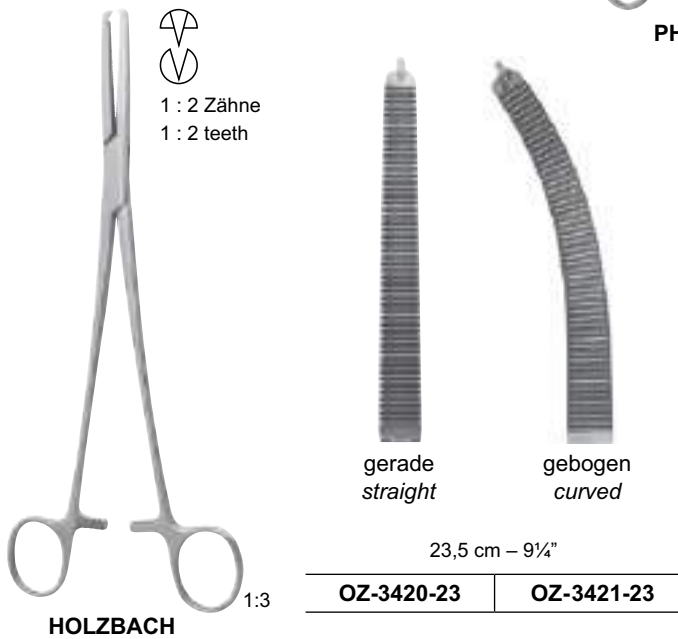
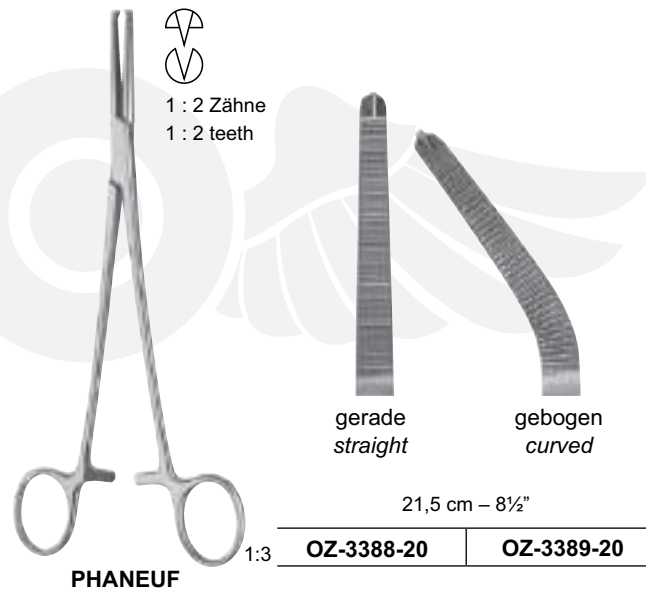



Hysterektomieklemmen Hysterectomy Forceps



WERTHEIM 1:3
gebogen
curved
25 cm – 10"
OZ-3430-25

WERTHEIM-CULLEN
gebogen
curved
90°
21,5 cm – 8½"
OZ-3432-21

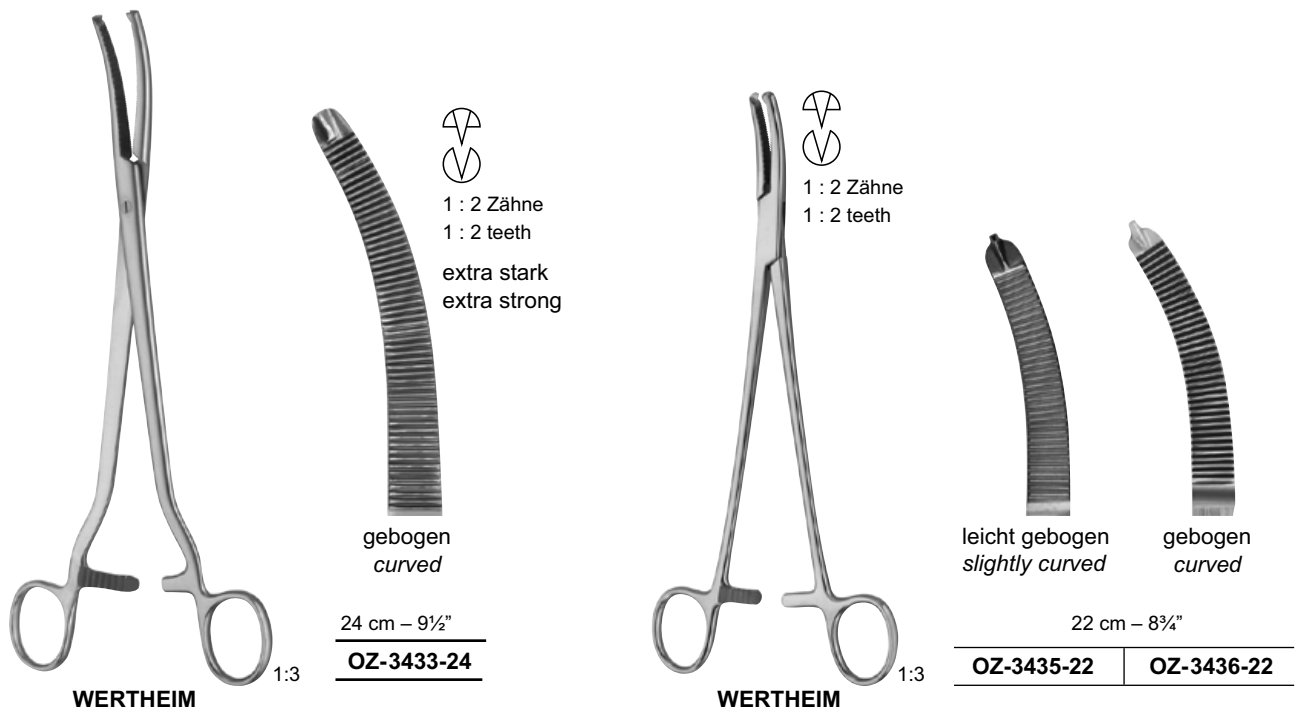

WERTHEIM 1:3
gebogen
curved
1 : 2 Zähne
1 : 2 teeth
extra stark
extra strong
24 cm – 9½"
OZ-3433-24

WERTHEIM 1:3
leicht gebogen
slightly curved
gebogen
curved
1 : 2 Zähne
1 : 2 teeth
22 cm – 8¾"
OZ-3435-22 | **OZ-3436-22**



OZZE MEDICAL & SURGICAL SUPPLIES
TOOLS TO OPERATE

Vaginalklemmen Vaginal Forceps

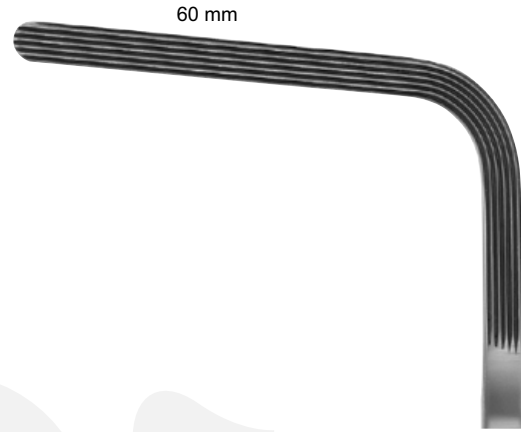

60 mm

23 cm – 9"

OZ-3434-01

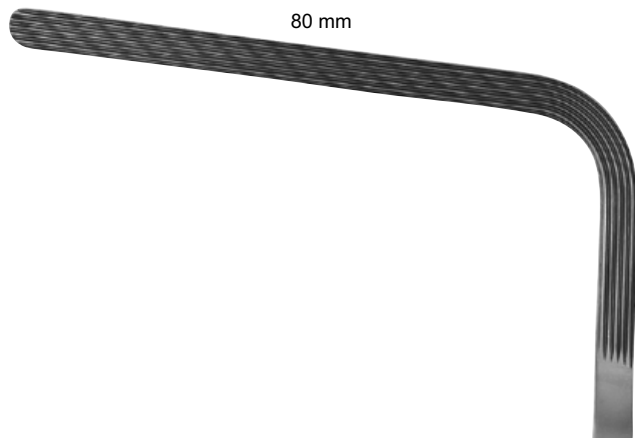

80 mm

23 cm – 9"

OZ-3434-02

Biopsieinstrumente Biopsy Instruments

4 mm

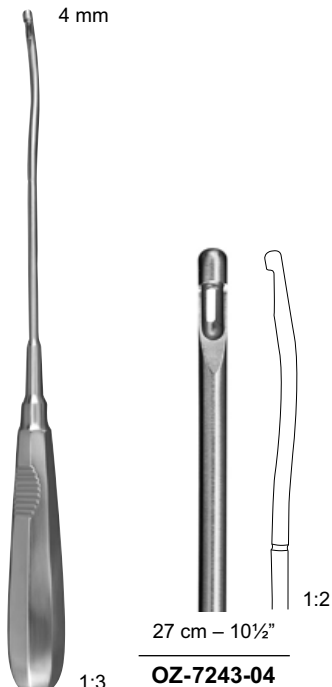

1:3

27 cm – 10½"

OZ-7243-04

**MÜNCHEN MODELL
MUNICH PATTERN**

für Endometrie
for endometrie

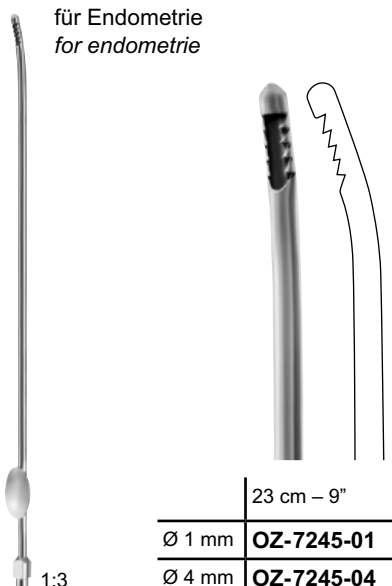

1:3

23 cm – 9"

Ø 1 mm	OZ-7245-01
Ø 4 mm	OZ-7245-04

NOVAK

für Endometrie
for endometrie

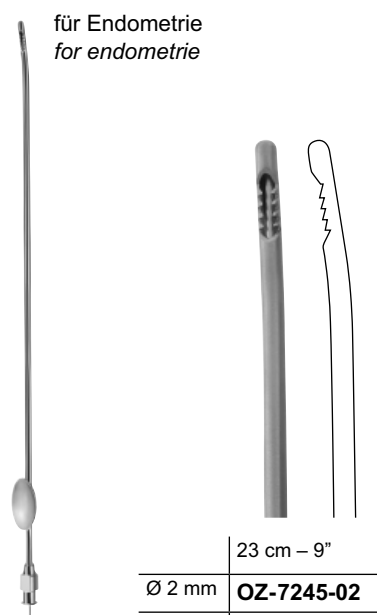

1:3

23 cm – 9"

Ø 2 mm	OZ-7245-02
Ø 3 mm	OZ-7245-03

NOVAK

für Endometrie
for endometrie

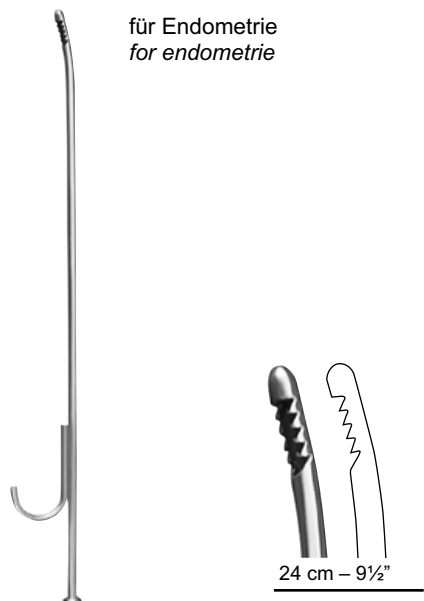

1:3

24 cm – 9½"

OZ-7245-51

NOVAK-SCHOECHAERT

Biopsieküretten Biopsy Curettes

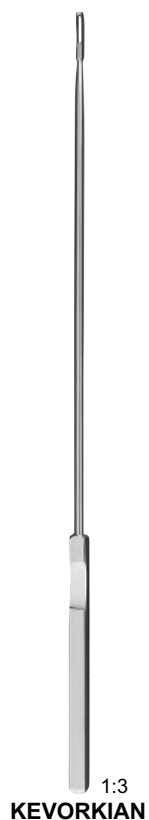
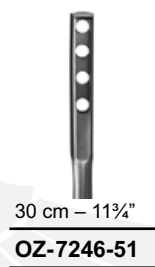
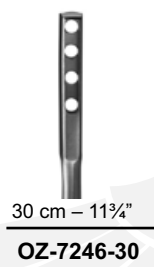
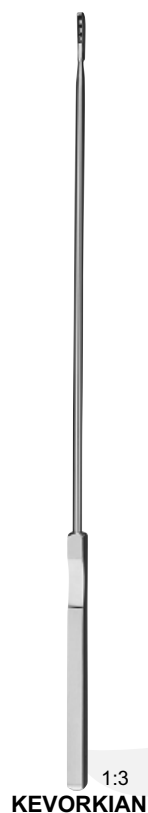

biegsam
malleable





Biopsiezangen Biopsy Forceps



THOMAS-GAYLOR

1:3



24 cm – 9½"

OZ-7252-24

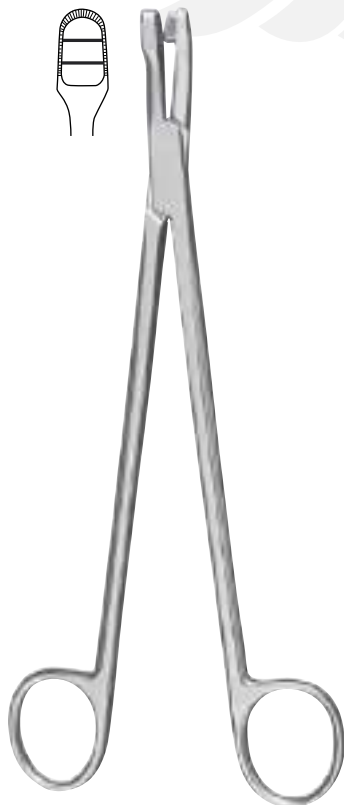

SCHUBERT

21 cm – 8¼"

OZ-7255-21

29 cm – 11½"

OZ-7255-29

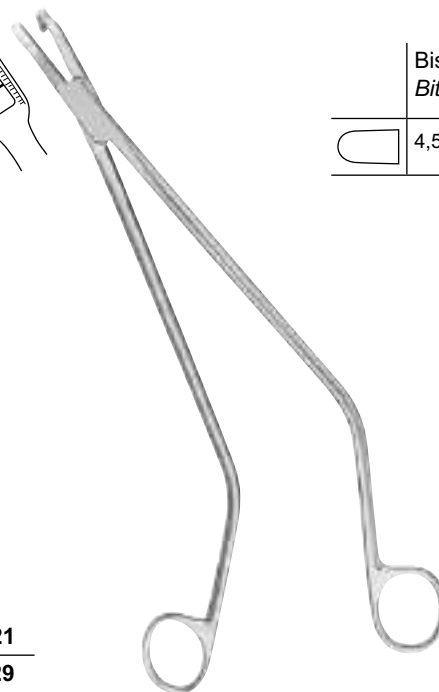

SCHUBERT

Bissbreite
Bite width

4,5 x 8 mm

1:3



26 cm – 10¼"

OZ-7256-26

Biopsiezangen Biopsy Forceps



TISCHLER



27 cm – 10½"

OZ-7257-27

	Bissbreite Bite width
	4 x 7 mm



VAN DOREN

Bissbreite
Bite width

	3,5 / 4 x 7 mm
---	----------------

25 cm – 10"

OZ-7258-01



VAN DOREN

25 cm – 10"

OZ-7258-25



SCHUMACHER



24 cm – 9½"

Fig. 1

Fig. 2

OZ-7261-24

OZ-7262-24

Biopsiezangen
Biopsy Forceps



FAURE

21 cm – 8¼"

OZ-7263-21

Biopsiezangen Biopsy Forceps

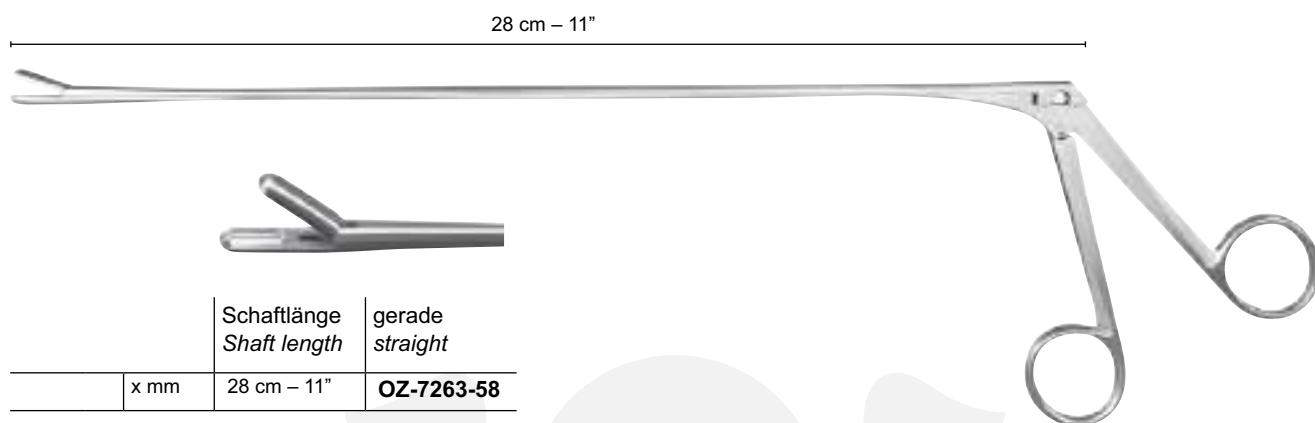

PATTERSON

	Schaftlänge Shaft length	gerade straight
x mm	28 cm - 11"	OZ-7263-58

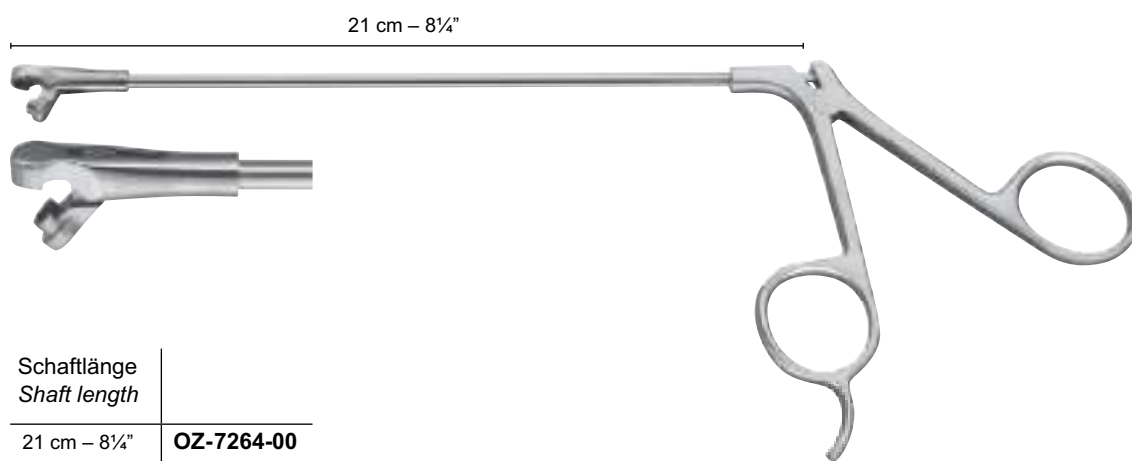



BERGER

Schaftlänge Shaft length	
21 cm - 8 1/4"	OZ-7264-00

Biopsiezangen Biopsy Forceps

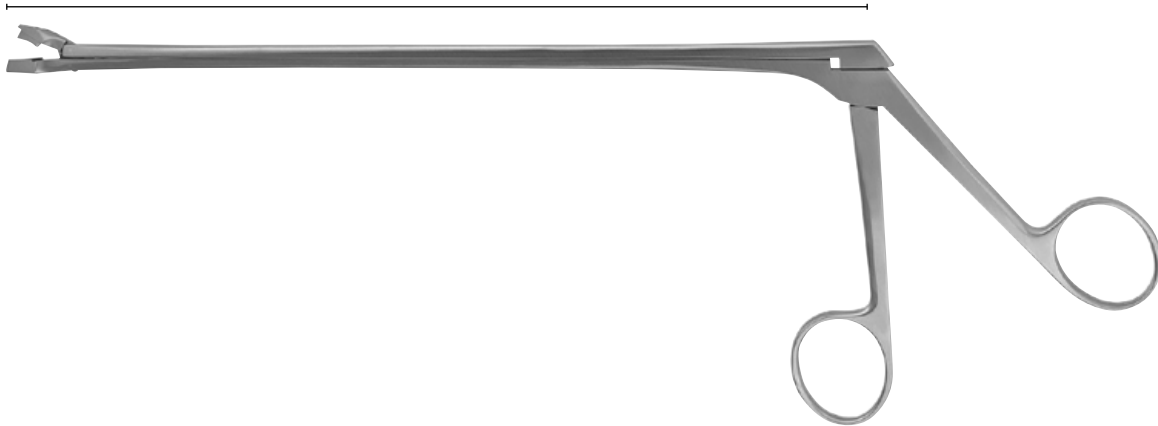
Schaftlänge
Shaft length





	Bissbreite Bite width	Schaftlänge Shaft length	DOUAY
	4 x 10 mm	20 cm – 8"	OZ-7264-20
		25 cm – 10"	OZ-7264-25
		30 cm – 11¼"	OZ-7264-30



	Bissbreite Bite width	Schaftlänge Shaft length	EPPENDORF
	4 x 8 mm	20 cm – 8"	OZ-7267-00
			OZ-7267-00P



	Schaftlänge Shaft length	Bissbreite Bite width	SCHUMACHER
	24 cm – 9½"	4 mm	OZ-7265-00
	24 cm – 9½"	4 mm	OZ-7265-00P
	24 cm – 9½"	6 mm	OZ-7265-06
	24 cm – 9½"	6 mm	OZ-7265-06P



	Bissbreite Bite width	Schaftlänge Shaft length	KEVORKIAN
	3 x 8 mm	24 cm – 9½"	OZ-7266-00
			OZ-7266-00P

ProClean = verbesserte Reinigung dank zerlegbarem Schiebeschäft
Erkennungsmerkmal: zusätzlich endet die Artikelnummer mit dem Buchstaben „P“

ProClean = improved cleaning by dismantlable sliding sheath
Identifying feature: additionally the article number ends with the letter "P"



OZZE MEDICAL & SURGICAL SUPPLIES
TOOLS TO OPERATE

Biopsiezangen Biopsy Forceps

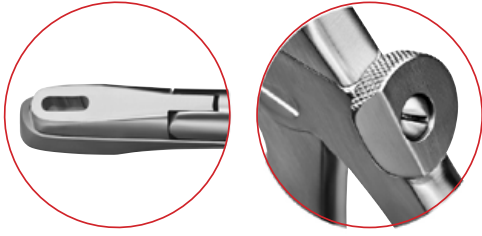

Verriegelung, geschlossen
Lock, locked

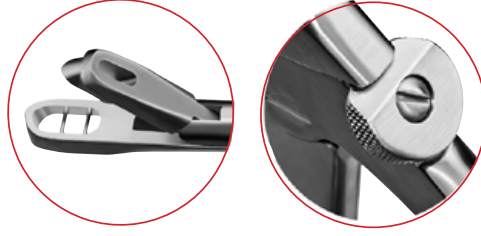

Verriegelung, offen
Lock, unlocked

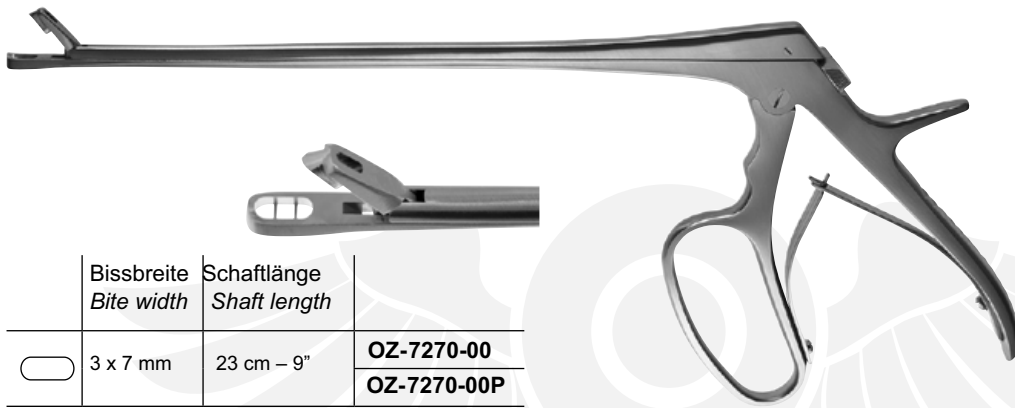

TISCHLER-MORGAN

	Bissbreite Bite width	Schaftlänge Shaft length	
	3 x 7 mm	23 cm – 9"	OZ-7270-00
			OZ-7270-00P



BABY-TISCHLER

	Bissbreite Bite width	Schaftlänge Shaft length	
	2,3 x 6,5 mm	21 cm – 8¼"	OZ-7270-50
			OZ-7270-50P



OZZE MEDICAL & SURGICAL SUPPLIES
TOOLS TO OPERATE

Uterus-Biopsiezangen Uterine Biopsy Forceps



Schaftlänge
Shaft length

24 cm – 9½" **OZ-7272-00**

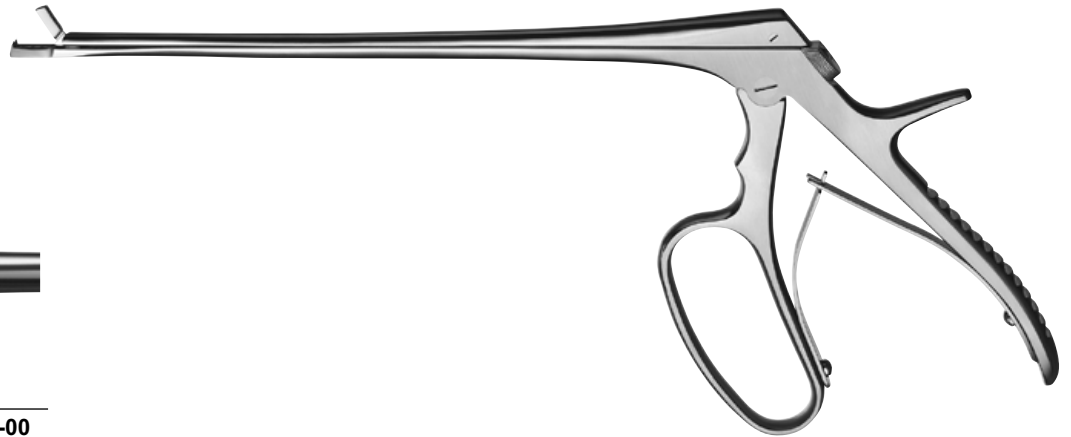

PACIFIC-KEVORKIAN

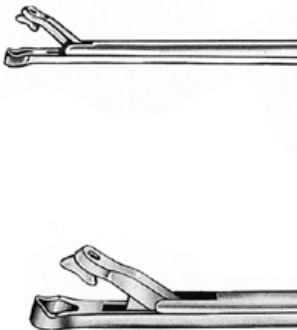

Schaftlänge
Shaft length

23 cm – 9" **OZ-7273-00**

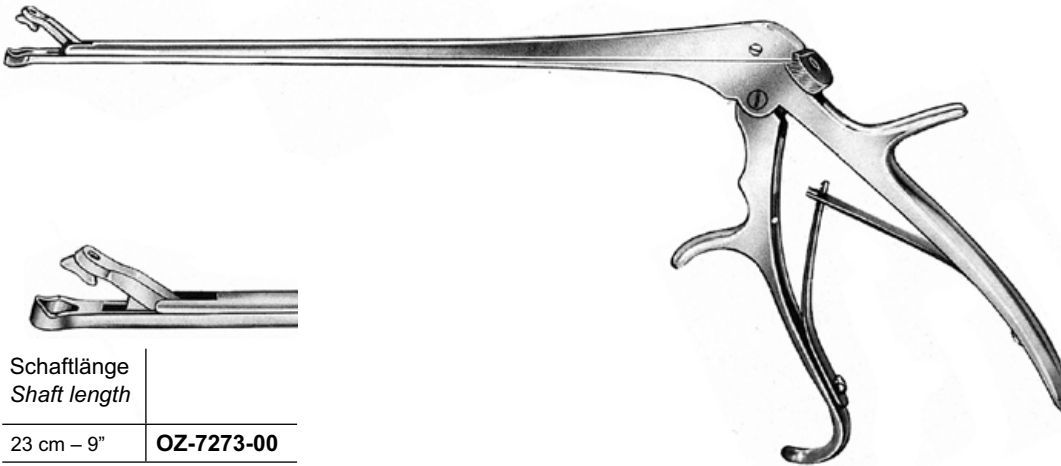

BURKE



	Bissbreite Bite width	Schaftlänge Shaft length	
	3 x 4,5 mm	28 cm – 11"	OZ-7271-00

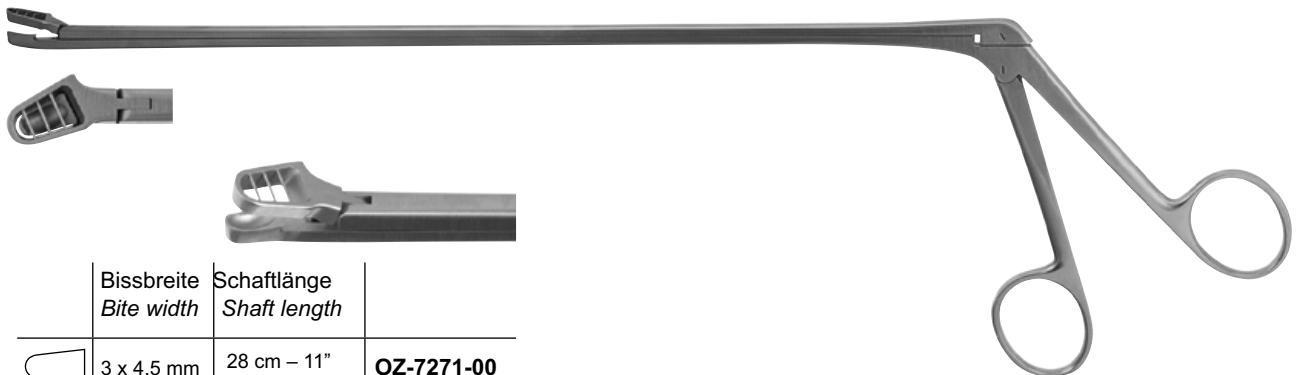

ALEXANDER



Uterus-Biopsiezangen Uterine Biopsy Forceps

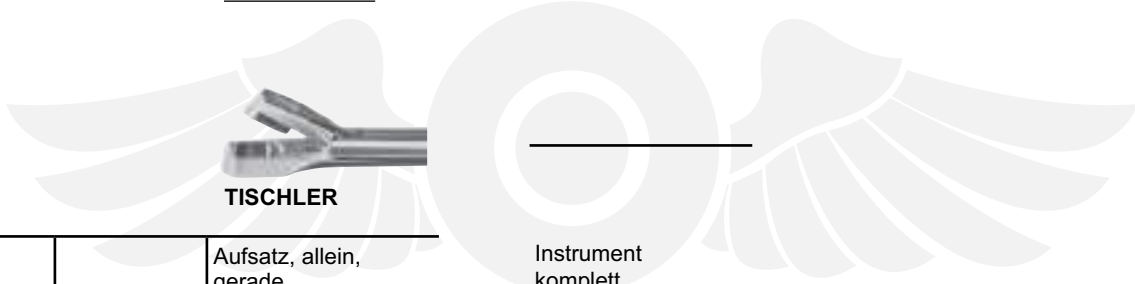
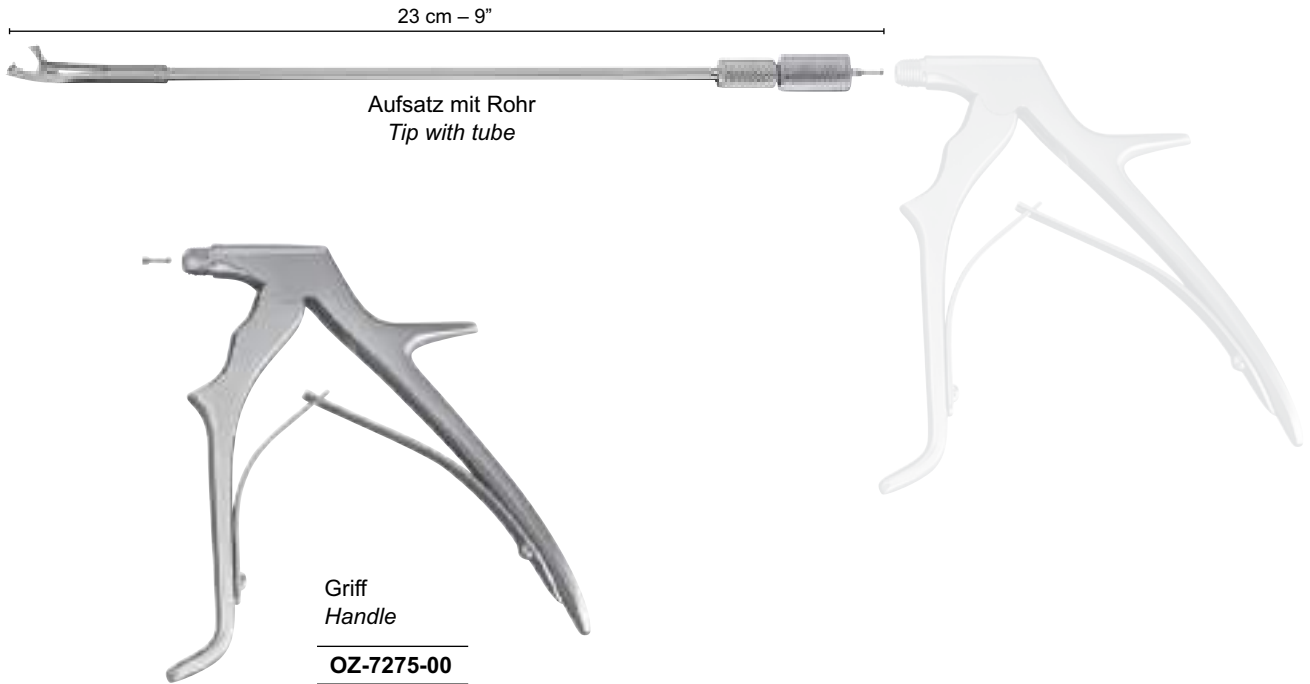

Längelength	Bissbreite <i>Bite width</i>	Aufsatz, allein, gerade <i>Tip, only, straight</i>
23 cm – 9"	3 x 7 mm	OZ-7275-10

Instrument
komplett
*Instrument
complete*

OZ-7275-11



MINI-TOWNSEND-UP

Längelength	Bissbreite <i>Bite width</i>	Aufsatz, allein, auf- wärts gebogen, <i>Tip, only, curved up</i>
23 cm – 9"	2,3 x 5 mm	OZ-7275-70

Instrument
komplett
*Instrument
complete*

OZ-7275-71



MINI-TOWNSEND-DOWN

Längelength	Bissbreite <i>Bite width</i>	Aufsatz, al- lein, abwärts gebogen, <i>Tip, only, curved down</i>
23 cm – 9"	2,3 x 5 mm	OZ-7275-80

Instrument
komplett
*Instrument
complete*

OZ-7275-81



Uteruslöffel Uterine Scoops



scharf, fest
sharp, rigid

1:3
SCHRÖDER

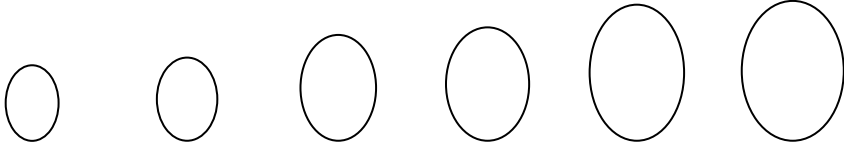

30 cm – 11 $\frac{3}{4}$ "

Fig. 1	Fig. 2	Fig. 3	Fig. 4	Fig. 5	Fig. 6
OZ-7280-01	OZ-7280-02	OZ-7280-03	OZ-7280-04	OZ-7280-05	OZ-7280-06



scharf, fest
sharp, rigid

1:3
SIMON

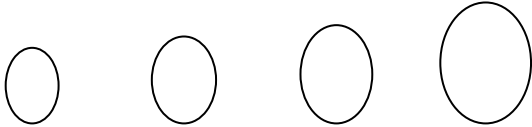

25 cm – 10"

Fig. 1	Fig. 2	Fig. 3	Fig. 4
OZ-7282-01	OZ-7282-02	OZ-7282-03	OZ-7282-04



Uterusküretten Uterine Curettes

GOURDET

stumpf
blunt

6 mm 8 mm 10 mm

28 cm – 11"

Fig. 1	Fig. 2	Fig. 3
OZ-7281-01	OZ-7281-02	OZ-7281-03

12 mm 14 mm

28 cm – 11"

Fig. 4	Fig. 5
OZ-7281-04	OZ-7281-05

1:3

THOMAS

stumpf
blunt

28 cm – 11"

Fig. 1	Fig. 2	Fig. 3
OZ-7283-01	OZ-7283-02	OZ-7283-03

28 cm – 11"

Fig. 4	Fig. 5	Fig. 6
OZ-7283-04	OZ-7283-05	OZ-7283-06

1:3

HEANEY

24 cm – 9½"

OZ-7286-24

1:3

HEANEY

24 cm – 9½"

OZ-7287-24

1:3

Uterusküretten Uterine Curettes

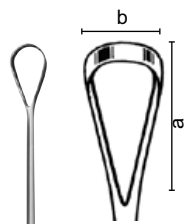

1:3
SIMS



28 cm – 11"

	Fig. 1	Fig. 2	Fig. 3	Fig. 4	Fig. 5	Fig. 6
a x b	15 x 7,5 mm	17,5 x 8,5 mm	20 x 10,5 mm	22 x 12 mm	24 x 14 mm	28 x 15 mm
biegsam, scharf <i>malleable, sharp</i>	OZ-7300-01	OZ-7300-02	OZ-7300-03	OZ-7300-04	OZ-7300-05	OZ-7300-06
biegsam, stumpf <i>malleable, blunt</i>	OZ-7302-01	OZ-7302-02	OZ-7302-03	OZ-7302-04	OZ-7302-05	OZ-7302-06
fest, scharfrigid, <i>sharp</i>	OZ-7304-01	OZ-7304-02	OZ-7304-03	OZ-7304-04	OZ-7304-05	OZ-7304-06
fest, stumpfrigid, <i>blunt</i>	OZ-7306-01	OZ-7306-02	OZ-7306-03	OZ-7306-04	OZ-7306-05	OZ-7306-06

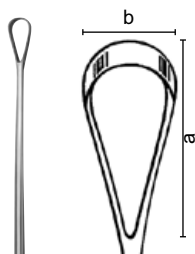

1:3
RECAMIER

		26 cm – 10¼"		
		biegsam <i>malleable</i>	festrigid	festrigid
Fig.	a x b mm	scharf <i>sharp</i>	scharf <i>sharp</i>	stumpf <i>blunt</i>
00	9 x 5	OZ-7310-05	OZ-7314-05	OZ-7316-05
0	12 x 6	OZ-7310-06	OZ-7314-06	OZ-7316-06
1	14 x 7	OZ-7310-07	OZ-7314-07	OZ-7316-07
2	16 x 8	OZ-7310-08	OZ-7314-08	OZ-7316-08
3	18 x 9	OZ-7310-09	OZ-7314-09	OZ-7316-09
4	22 x 11	OZ-7310-11	OZ-7314-11	OZ-7316-11
5	24 x 12	OZ-7310-12	OZ-7314-12	OZ-7316-12
6	28 x 14	OZ-7310-14	OZ-7314-14	OZ-7316-14
7	33 x 15	OZ-7310-15	OZ-7314-15	OZ-7316-15
8	35 x 16	OZ-7310-16	OZ-7314-16	OZ-7316-16



Uterusküretten Uterine Curettes

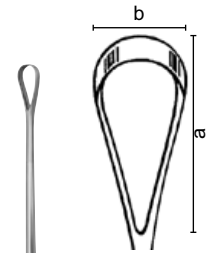

1:3
RECAMIER

	<i>mallea-ble</i>	biegsam	<i>festrigid</i>	<i>festrigid</i>
Fig.	a x b mm	<i>scharfsharp</i>	<i>scharfsharp</i>	<i>stumpfb blunt</i>
31 cm – 12¼"				
00	9 x 5	OZ-7318-05	OZ-7322-05	OZ-7324-05
0	12 x 6	OZ-7318-06	OZ-7322-06	OZ-7324-06
1	14 x 7	OZ-7318-07	OZ-7322-07	OZ-7324-07
2	16 x 8	OZ-7318-08	OZ-7322-08	OZ-7324-08
3	18 x 9	OZ-7318-09	OZ-7322-09	OZ-7324-09
4	22 x 11	OZ-7318-11	OZ-7322-11	OZ-7324-11
5	24 x 12	OZ-7318-12	OZ-7322-12	OZ-7324-12
6	28 x 14	OZ-7318-14	OZ-7322-14	OZ-7324-14
7	33 x 15	OZ-7318-15	OZ-7322-15	OZ-7324-15
8	35 x 16	OZ-7318-16	OZ-7322-16	OZ-7324-16
9	38 x 19	OZ-7318-19	OZ-7322-19	OZ-7324-19
10	40 x 20	OZ-7318-20	OZ-7322-20	OZ-7324-20
11	45 x 21	OZ-7318-21	OZ-7322-21	OZ-7324-21
12	48 x 23	OZ-7318-23	OZ-7322-23	OZ-7324-23
34 cm – 13½"				
13	50 x 25	OZ-7318-25	OZ-7322-25	OZ-7324-25
14	55 x 30	OZ-7318-30	OZ-7322-30	OZ-7324-30
15	60 x 35	OZ-7318-35	OZ-7322-35	OZ-7324-35
16	65 x 40	OZ-7318-40	OZ-7322-40	OZ-7324-40

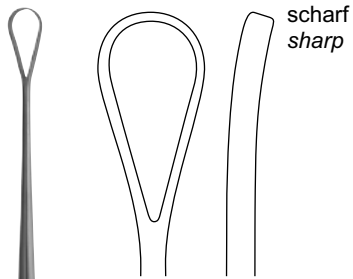

27 cm – 10½"

OZ-7330-27

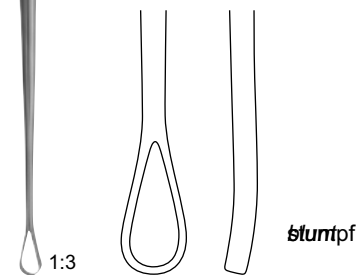

1:3
BLAKE

Biopsie- und Absaugküretten Biopsy and Aspirating Curettes



graduiert
graduated

Ø mm	28 cm – 11"
4	OZ-7289-04
6	OZ-7289-06
8	OZ-7289-08
10	OZ-7289-10
12	OZ-7289-12
14	OZ-7289-14

1:3



Schlauch-Verbindungstück
Tube connecting piece

OZ-7289-50



MILAN

1:3



Ø 5 mm



28,5 cm – 11¼"

Ø 7 mm



Ø 9 mm

biegsam-
malleable

OZ-7290-05

OZ-7290-07

OZ-7290-09

Salpingograph Salpingograph



SCHULTZE

Salpingograph zur Hystereo-Salpingographie
 komplett in Holzetui, bestehend aus:

Salpingograph for utero-salpingography
 complete in wooden case, consisting of:

OZ-7350-00

- 1 Manometer (OZ-7350-01)
- 1 Manometer (OZ-7350-01)
- 1 Zwischenstück, ohne Manometer (OZ-7350-02)
- 1 Connection, without manometer (OZ-7350-02)
- 1 Tubenkatheter mit Hahn, ohne Kugel (OZ-7350-03)
- 1 Uterine cannula with tap, without cone (OZ-7350-03)
- 1 Kegel, klein (OZ-7350-04)
- 1 Cone, small (OZ-7350-04)
- 1 Kegel, mittel (OZ-7350-05)
- 1 Cone, medium (OZ-7350-05)
- 1 Kegel, groß (OZ-7350-06)
- 1 Cone, large (OZ-7350-06)
- 1 Holzetui (OZ-7350-20)
- 1 Wooden case (OZ-7350-20)

Manometer
 Manometer

OZ-7350-01



Zwischenstück
 Connection

OZ-7350-02



Tubenkatheter
 mit Hahn, ohne Kugel
 Uterine cannula
 with tap, without cone

OZ-7350-03



klein
 small

OZ-7350-04



mittel
 medium

OZ-7350-05



groß
 large

OZ-7350-06

Salpingograph Salpingograph



SCHULTZE

Salpingograph zur Hystereo-Salpingographie
komplett in Holzetui, bestehend aus:

OZ-7360-00

Salpingograph for utero-salpingography
complete in wooden case, consisting of:

- 1 Zwischenstück, ohne Manometer (OZ-7350-02)
- 1 Connection, without manometer (OZ-7350-02)
- 1 Tubenkatheter mit Hahn, ohne Kugel (OZ-7350-03)
- 1 Uterine cannula with tap, without cone (OZ-7350-03)
- 1 Kegel, klein (OZ-7350-04)
- 1 Cone, small (OZ-7350-04)
- 1 Kegel, mittel (OZ-7350-05)
- 1 Cone, medium (OZ-7350-05)
- 1 Kegel, groß (OZ-7350-06)
- 1 Cone, large (OZ-7350-06)
- 1 Holzetui (OZ-7350-20)
- 1 Wooden case (OZ-7350-20)

Zwischenstück
Connection

OZ-7350-02



Tubenkatheter
mit Hahn, ohne Kugel
Uterine cannula
with tap, without cone

OZ-7350-03



klein
small

OZ-7350-04



mittel
medium

OZ-7350-05



groß
large

OZ-7350-06



DE MARTEL (WILLET)

14 cm – 5½"
OZ-3426-14



DE MARTEL (WILLET)

19 cm – 7½"
OZ-7420-19

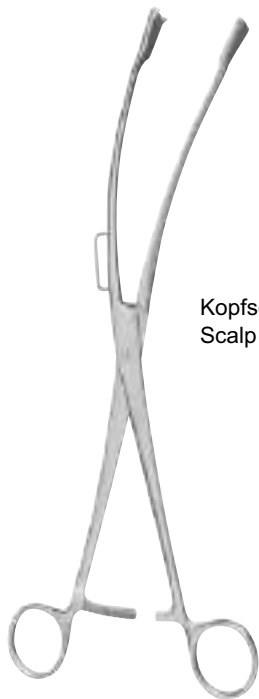

GAUSS

Kopfschwartzange
Scalp flap forceps

26 cm – 10¼"
OZ-7419-26

1:3



SELLHEIM

Geburtslöffel Ele-
vating spoon

28 cm – 11"
OZ-7425-28

1:3



Perforatorium
Perforator

25 cm – 10"

OZ-7432-25

NÄGELE



Nabelschnurklemme
Umbilical cord clamp

9 cm – 3½"

OZ-7436-29

COLLIN



OZZE MEDICAL & SURGICAL SUPPLIES
TOOLS TO OPERATE

Geburtszangen Obstetrical Forceps



1:4
SIMPSON-LUIKART

36,5 cm – 14½"
OZ-7447-36



1:3
SIMPSON

23 cm – 9"
OZ-7445-23



1:4
SIMPSON

30 cm – 11¼"
OZ-7445-30



1:4
WRIGLEY

28 cm – 11"
OZ-7442-28



Geburtszangen Obstetrical Forceps

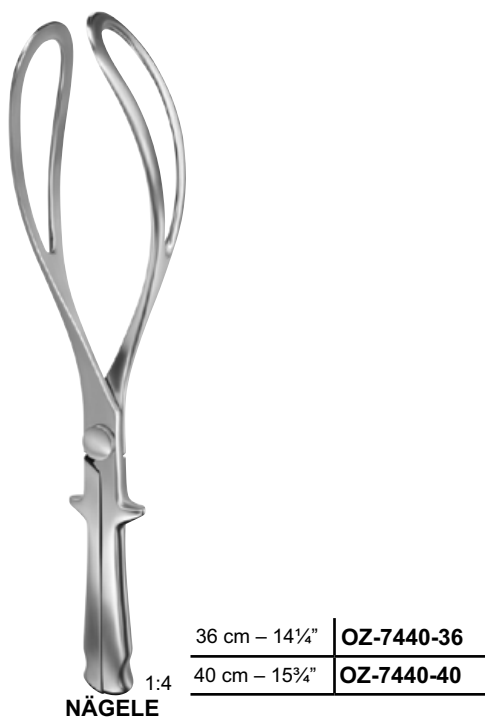
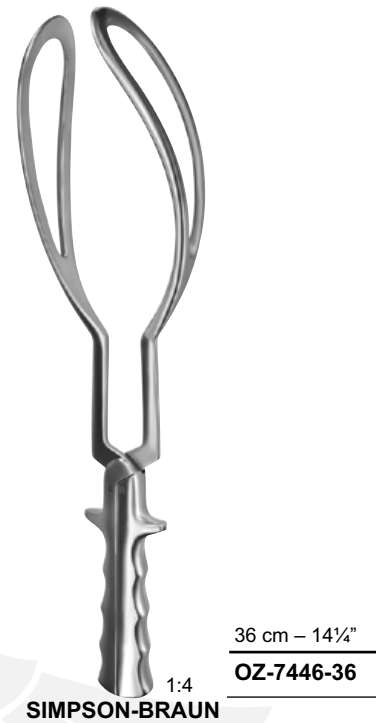



OZZE MEDICAL & SURGICAL SUPPLIES
TOOLS TO OPERATE

Geburtszangen Obstetrical Forceps

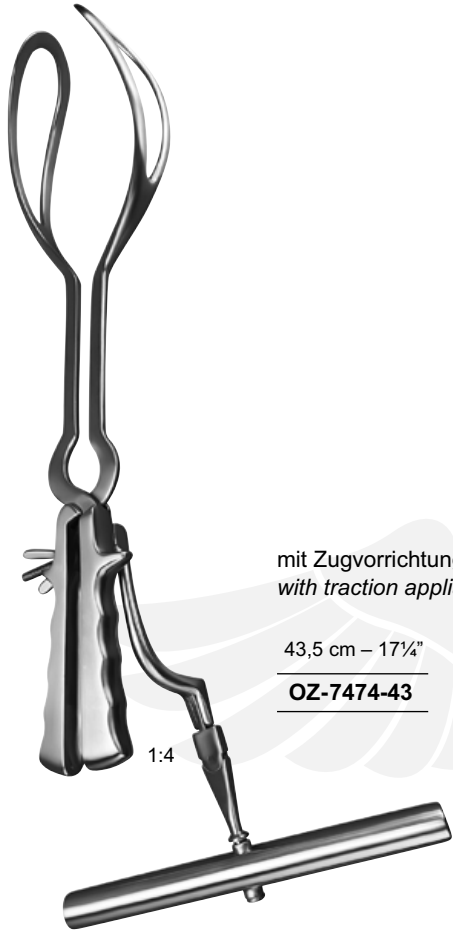

mit Zugvorrichtung
with traction appliance

43,5 cm – 17¼"

OZ-7474-43

BARNES-NEVILLE



für nachkommenden
Kopf bei Steisslagen
*for delivery of the after
coming head in breech
presentation*

44 cm – 17¼"

OZ-7472-44

PIPER

Abortuszangen Ovum Forceps



gerade
straight

28 cm – 11"

OZ-7410-01	OZ-7410-02	OZ-7410-03
------------	------------	------------



gebogen
curved

28 cm – 11"

OZ-7411-01	OZ-7411-02	OZ-7411-03
------------	------------	------------



Abortus- und Plazentarzangen
Ovum and Placenta Forceps



Abortuszangen
Ovum forceps

1:3

SÄNGER



gerade
straight



gebogen
curved

27 cm – 10½"

OZ-7414-27

OZ-7415-27



Plazentazange
Placenta forcep

1:3

BARRETT

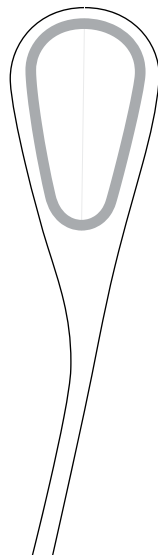

leicht gebogen
slightly curved

25,5 cm – 10"

OZ-7413-25

Uterusklemmzangen
Uterine Forceps

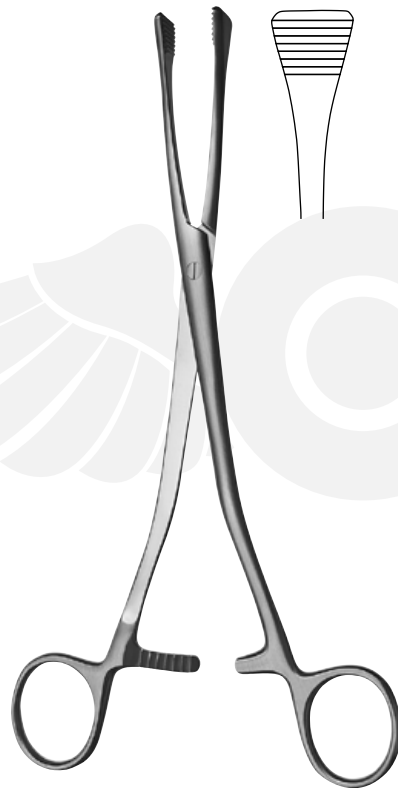

GREEN-ARMYTAGE

21 cm – 8¼"

OZ-7418-21



©ZZE MEDICAL & SURGICAL SUPPLIES

TOOLS TO OPERATE



TEN

 www.ozzesurgical.com.au

 info@ozzesurgical.com.au

Meißel und Osteotome	<i>Chisels and Osteotomes</i>	BS 1 - 8
Scharfe Löffel	<i>Bone Curettes</i>	BS 9 - 15
Knochenraspel	<i>Bone Rasps</i>	BS 16
Rasparatorien	<i>Raspatories</i>	BS 17 - 24
Rasparatorien und Elevatorien	<i>Raspatories and Elevators</i>	BS 25
Elevatorien	<i>Elevators</i>	BS 26 - 27
Knochenhebel	<i>Bone Levers</i>	BS 28 - 31
Knochenhaken	<i>Bone Retractors</i>	BS 32 - 34
Spinalhaken, Meniskusmesser	<i>Spinal Retractors, Meniscus Knives</i>	BS 35
Knochenhaltezangen	<i>Bone Holding Forceps</i>	BS 36 - 44
Hohlmeißelzangen	<i>Bone Rongeurs</i>	BS 45 - 56
Knochensplitterzangen	<i>Bone Cutting Forceps</i>	BS 57 - 59
Instrumente für Fingernägel	<i>Nail Instruments</i>	BS 60
Sägen und Sägeblätter	<i>Saws and Saw Blades</i>	BS 61 - 62
Bohrapparate	<i>Hand Drills</i>	BS 63 - 65
Reibahlen	<i>Reamers</i>	BS 66
Bohrdrähte, Steinmann-Nägel	<i>Drill Wires, Steinmann Pins</i>	BS 67 - 69
Drahtspannzangen	<i>Wire Twisting Forceps</i>	BS 70 - 71
Drahtfasszangen	<i>Wire Holding Forceps</i>	BS 72
Flachzangen	<i>Flat Nose Pliers</i>	BS 73
Drahtschneidezangen	<i>Wire Cutting Pliers</i>	BS 74 - 76
Extensionsbügel	<i>Extension Bows</i>	BS 77
Cerclage-Instrumente	<i>Cerclage Instruments</i>	BS 78
Hämmer	<i>Mallets</i>	BS 79 - 84
Sehneninstrumente, Bleihand	<i>Tendon Instruments, Lead hand</i>	BS 85 - 87



Meißel und Osteotome Chisels and Osteotomes



Griff
Handle

OZ-5301-00



5 mm

OZ-5301-05



10 mm

OZ-5301-10



16 mm

OZ-5301-16



25 mm

OZ-5301-25

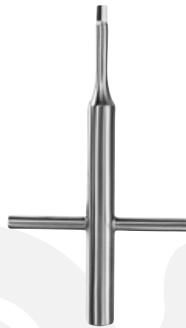

Schlüssel
Wrench

OZ-5301-06

Satz Meißel komplett, bestehend aus:
Chisel set complete, consisting of:

OZ-5301-50

- 1 Griff OZ-5301-00)
- 1 Handle (OZ-5301-00)
- 1 Meißelklinge, 10 mm (OZ-5301-10)
- 1 Chisel blade, 10 mm (OZ-5301-10)
- 1 Meißelklinge, 16 mm (OZ-5301-16)
- 1 Chisel blade, 16 mm (OZ-5301-16)
- 1 Meißelklinge, 25 mm (OZ-5301-25)
- 1 Chisel blade, 25 mm (OZ-5301-25)
- 1 Schlüssel (OZ-5301-06)
- 1 Wrench (OZ-5301-06)

Meißelklinge, 5 mm (OZ-5301-05) optional
Chisel blade, 5 mm (OZ-5301-05) optional



gerade
straight



gerade
straight



gerade
straight



gerade
straight



	Osteotome Osteotomes	Flachmeißel Chisels	Hohlmeißel Gouges
	13,5 cm – 5¼"		
4 mm	OZ-5300-04	OZ-5302-04	OZ-5304-04
6 mm	OZ-5300-06	OZ-5302-06	OZ-5304-06
8 mm	OZ-5300-08	OZ-5302-08	OZ-5304-08
10 mm	OZ-5300-10	OZ-5302-10	OZ-5304-10
12 mm	OZ-5300-12	OZ-5302-12	OZ-5304-12
14 mm	OZ-5300-14	OZ-5302-14	OZ-5304-14
16 mm	OZ-5300-16	OZ-5302-16	OZ-5304-16



LUCAS

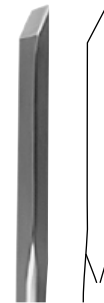

gerade
straight

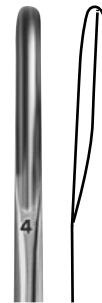

gerade
straight

	Flachmeißel Chisels	Hohlmeißel Gouges
	16 cm – 6¼"	
4 mm	OZ-5305-34	OZ-5305-44
6 mm	OZ-5305-36	OZ-5305-46



Meißel und Osteotome Chisels and Osteotomes



MODELL USA
USA PATTERN

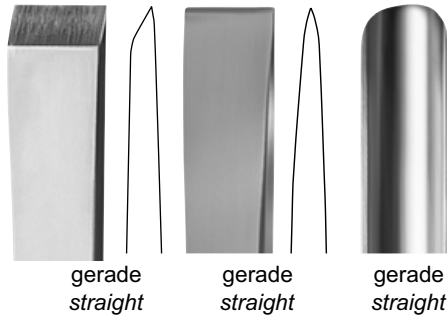

	Flachmeißel Chisels	Osteotome Osteotomes	Hohlmeißel Gouges
	16 cm – 6¼"		
6 mm	OZ-5311-01	OZ-5311-11	OZ-5311-21
12 mm	OZ-5311-02	OZ-5311-12	OZ-5311-22
18 mm	OZ-5311-03	OZ-5311-13	OZ-5311-23



Stößel
Pestles

	3 mm	5 mm
	16 cm – 6¼"	
	OZ-5317-03	OZ-5317-05
	7 mm	9 mm
	16 cm – 6¼"	
	OZ-5317-07	OZ-5317-09

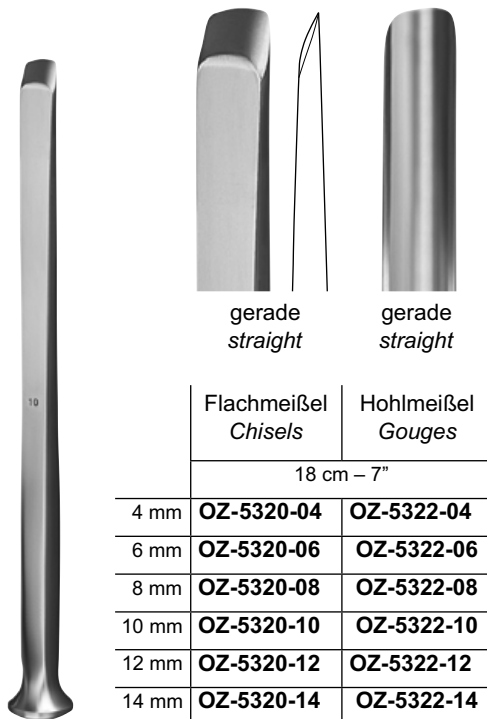

ALEXANDER

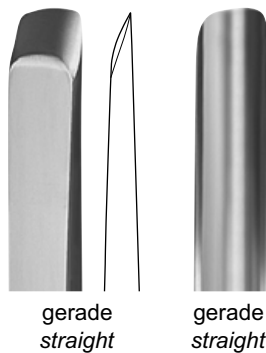

	Flachmeißel Chisels	Hohlmeißel Gouges
	18 cm – 7"	
4 mm	OZ-5320-04	OZ-5322-04
6 mm	OZ-5320-06	OZ-5322-06
8 mm	OZ-5320-08	OZ-5322-08
10 mm	OZ-5320-10	OZ-5322-10
12 mm	OZ-5320-12	OZ-5322-12
14 mm	OZ-5320-14	OZ-5322-14

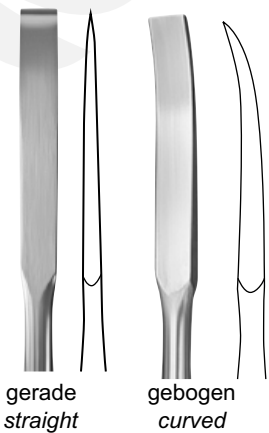

	Osteotome Osteotomes	Osteotome Osteotomes
	14 cm – 5½"	
2 mm	OZ-5321-01	OZ-5321-11
3 mm	OZ-5321-02	OZ-5321-12
4 mm	OZ-5321-03	OZ-5321-13
5 mm	OZ-5321-04	OZ-5321-14
6 mm	OZ-5321-05	OZ-5321-15
7 mm	OZ-5321-06	OZ-5321-16
8 mm	OZ-5321-07	OZ-5321-17



HOKE



Meißel und Osteotome Chisels and Osteotomes



Osteotome mit Markierung
Osteotomes with depth marking

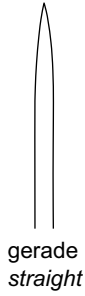

gerade
straight

18 cm – 7"

2 mm	OZ-8253-02
4 mm	OZ-8253-04
6 mm	OZ-8253-06
7 mm	OZ-8253-07
9 mm	OZ-8253-09
12 mm	OZ-8253-12

COTTLE



Flachmeißel mit Markierung
Chisels with depth marking



gerade
straight

18 cm – 7"

4 mm	OZ-8258-04
6 mm	OZ-8258-06
7 mm	OZ-8258-07
9 mm	OZ-8258-09
12 mm	OZ-8258-12

COTTLE



SMITH-PETERSEN

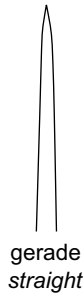

gerade
straight



gebogen
curved



gerade
straight



gebogen
curved

	Osteotome Osteotomes		Hohlmeißel Gouges	
	20,5 cm – 8"			
6 mm	OZ-5323-06	OZ-5325-06	OZ-5327-06	OZ-5329-06
9 mm	OZ-5323-09	OZ-5325-09	OZ-5327-09	OZ-5329-09
13 mm	OZ-5323-13	OZ-5325-13	OZ-5327-13	OZ-5329-13
16 mm	OZ-5323-16	OZ-5325-16	OZ-5327-16	OZ-5329-16
19 mm	OZ-5323-19	OZ-5325-19	OZ-5327-19	OZ-5329-19
25 mm	OZ-5323-25	OZ-5325-25	OZ-5327-25	OZ-5329-25
32 mm	OZ-5323-32	OZ-5325-32	OZ-5327-32	OZ-5329-32



Meißel und Osteotome Chisels and Osteotomes



LAMBOTTE

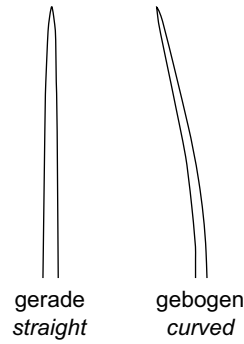

	Osteotome Osteotomes	
	24,5 cm – 9 ³ / ₄ "	
4 mm	OZ-5330-04	OZ-5331-04
6 mm	OZ-5330-06	OZ-5331-06
8 mm	OZ-5330-08	OZ-5331-08
10 mm	OZ-5330-10	OZ-5331-10
13 mm	OZ-5330-13	OZ-5331-13
16 mm	OZ-5330-16	OZ-5331-16
18 mm	OZ-5330-18	OZ-5331-18
20 mm	OZ-5330-20	OZ-5331-20
25 mm	OZ-5330-25	OZ-5331-25
30 mm	OZ-5330-30	OZ-5331-30
38 mm	OZ-5330-38	OZ-5331-38
44 mm	OZ-5330-44	OZ-5331-44
50 mm	OZ-5330-50	OZ-5331-50



gerade
straight



MINI-LAMBOTTE

	Osteotome Osteotomes	
	12,5 cm – 5" – 6 ³ / ₄ "	17 cm
2 mm	OZ-5332-02	OZ-5333-02
3 mm	OZ-5332-03	OZ-5333-03
4 mm	OZ-5332-04	OZ-5333-04
6 mm	OZ-5332-06	OZ-5333-06
8 mm	OZ-5332-08	OZ-5333-08
10 mm	OZ-5332-10	OZ-5333-10
12 mm	OZ-5332-12	OZ-5333-12
15 mm	OZ-5332-15	OZ-5333-15

Meißel und Osteotome Chisels and Osteotomes

Instrumente mit **Propylux** Griffen

Ein hochstabiles Thermoplast mit wesentlich besseren Eigenschaften als das oft verwendete Ferrozell:

Exzellente Resistenz gegen Säuren und Laugen, daher hygienisch unbedenklicher als Ferrozell Hohe Formstabilität auch nach Hunderten von

Steri-Zyklen

Hohe Festigkeit auch bei extremer Beanspruchung

Hohe Farbbeständigkeit

Enorme Reduzierung von Reparaturen

Zugelassen bei der FDA

Geeignet für alle Sterilisationsverfahren

Instruments with **Propylux** Handles

A highly resistant thermoplastic having much better characteristics than the often used Ferrozell:

Excellent resistance against acids and leaches, therefore much safer than Ferrozell from the hygiene point of view

High form stability even after hundreds of sterilisation cycles

High solidity even when exposed to extreme loads

Highly colour-fast

Tremendously reduced need of repair

FDA approved

Suitable for all sterilisation procedures



LEXER



LEXER

gerade
straight

gerade
straight

Osteotome Osteotomes	Hohlmeißel Gouges
-------------------------	----------------------

22 cm – 8¾"

5 mm	OZ-5336-05X	OZ-5338-05X
7 mm	OZ-5336-07X	OZ-5338-07X
10 mm	OZ-5336-10X	OZ-5338-10X
15 mm	OZ-5336-15X	OZ-5338-15X
20 mm	OZ-5336-20X	OZ-5338-20X
25 mm	OZ-5336-25X	OZ-5338-25X
30 mm	OZ-5336-30X	OZ-5338-30X
40 mm	OZ-5336-40X	OZ-5338-40X

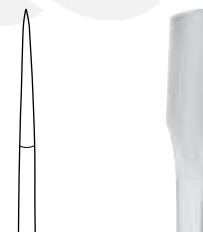

MINI-LEXER

gerade
straight

gerade
straight

Osteotome Osteotomes	Hohlmeißel Gouges
-------------------------	----------------------

18 cm – 7"

4 mm	OZ-5334-04X	OZ-5335-04X
6 mm	OZ-5334-06X	OZ-5335-06X
8 mm	OZ-5334-08X	OZ-5335-08X
10 mm	OZ-5334-10X	OZ-5335-10X
12 mm	OZ-5334-12X	OZ-5335-12X



Meißel und Osteotome Chisels and Osteotomes



STILLE

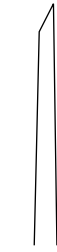

gerade
straight



gerade
straight



gebogen
curved



gerade
straight



gebogen
curved

	Flachmeißel Chisels	Osteotome Osteotomes		Hohlmeißel Gouges	
	20 cm – 8"				
6 mm	OZ-5340-06	OZ-5341-06	OZ-5341-56	OZ-5342-06	OZ-5342-56
8 mm	OZ-5340-08	OZ-5341-08	OZ-5341-58	OZ-5342-08	OZ-5342-58
10 mm	OZ-5340-10	OZ-5341-10	OZ-5341-60	OZ-5342-10	OZ-5342-60
12 mm	OZ-5340-12	OZ-5341-12	OZ-5341-62	OZ-5342-12	OZ-5342-62
15 mm	OZ-5340-15	OZ-5341-15	OZ-5341-65	OZ-5342-15	OZ-5342-65
20 mm	OZ-5340-20	OZ-5341-20	OZ-5341-70	OZ-5342-20	OZ-5342-70
25 mm	OZ-5340-25	OZ-5341-25	OZ-5341-75	OZ-5342-25	OZ-5342-75
30 mm	OZ-5340-30	OZ-5341-30	OZ-5341-80	OZ-5342-30	OZ-5342-80



HIBBS
1:3



gerade
straight



gebogen
curved

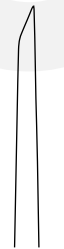

gerade
straight



gebogen
curved



gerade
straight



gebogen
curved

	Osteotome Osteotomes		Flachmeißel Chisels		Hohlmeißel Gouges	
	24 cm – 9½"		24 cm – 9½"		24 cm – 9½"	
6 mm	OZ-5344-06	OZ-5344-56	OZ-5345-06	OZ-5345-56	OZ-5346-06	OZ-5346-56
9 mm	OZ-5344-09	OZ-5344-59	OZ-5345-09	OZ-5345-59	OZ-5346-09	OZ-5346-59
13 mm	OZ-5344-13	OZ-5344-63	OZ-5345-13	OZ-5345-63	OZ-5346-13	OZ-5346-63
16 mm	OZ-5344-16	OZ-5344-66	OZ-5345-16	OZ-5345-66	OZ-5346-16	OZ-5346-66
19 mm	OZ-5344-19	OZ-5344-69	OZ-5345-19	OZ-5345-69	OZ-5346-19	OZ-5346-69
22 mm	OZ-5344-22	OZ-5344-72	OZ-5345-22	OZ-5345-72	OZ-5346-22	OZ-5346-72
25 mm	OZ-5344-25	OZ-5344-75	OZ-5345-25	OZ-5345-75	OZ-5346-25	OZ-5346-75
28 mm	OZ-5344-28	OZ-5344-78	OZ-5345-28	OZ-5345-78	OZ-5346-28	OZ-5346-78
32 mm	OZ-5344-32	OZ-5344-82	OZ-5345-32	OZ-5345-82	OZ-5346-32	OZ-5346-82
38 mm	OZ-5344-38	OZ-5344-88	OZ-5345-38	OZ-5345-88	OZ-5346-38	OZ-5346-88

Meißel und Osteotome Chisels and Osteotomes

Instrumente mit **Propylux** Griffen

Ein hochstabiles Thermoplast mit wesentlich besseren Eigenschaften als das oft verwendete Ferrozell:

- Exzellente Resistenz gegen Säuren und Laugen, daher hygienisch unbedenklicher als Ferrozell
- Hohe Formstabilität auch nach Hunderten von Steri-Zyklen
- Hohe Festigkeit auch bei extremer Beanspruchung
- Hohe Farbbeständigkeit
- Enorme Reduzierung von Reparaturen
- Zugelassen bei der FDA
- Geeignet für alle Sterilisationsverfahren

Instruments with **Propylux** Handles

A highly resistant thermoplastic having much better characteristics than the often used Ferrozell:

- Excellent resistance against acids and leaches, therefore much safer than Ferrozell from the hygiene point of view
- High form stability even after hundreds of sterilisation cycles
- High solidity even when exposed to extreme loads
- Highly colour-fast
- Tremendously reduced need of repair
- FDA approved
- Suitable for all sterilisation procedures



Meißel und Osteotome Chisels and Osteotomes



Hohlmeißel
Gouges

27,5 cm – 10¾"

OZ- 5349-01	OZ- 5349-02	OZ-5349-03	OZ-5349-04
-------------	-------------	------------	------------

Scharfe Löffel Bone Curettes



Fig. 0000 – 2,5 mm

OZ-5350-40

Fig. 000 – 3,6 mm

OZ-5350-30

Fig. 00 – 4,4 mm

OZ-5350-20

Fig. 0 – 5,2 mm

OZ-5350-10

Fig. 1 – 6,8 mm

OZ-5350-01

Fig. 2 – 8,5 mm

OZ-5350-02

Fig. 3 – 10 mm

OZ-5350-03

Fig. 4 – 11,5 mm

OZ-5350-04

Fig. 5 – 13 mm

OZ-5350-05

Fig. 6 – 14,5 mm

OZ-5350-06



Fig. 000 – 3,3 mm

OZ-5351-08 **OZ-5351-58** **OZ-5351-78**

Fig. 00 – 3,9 mm

OZ-5351-09 **OZ-5351-59** **OZ-5351-79**

Fig. 0 – 4,7 mm

OZ-5351-10 **OZ-5351-60** **OZ-5351-80**

Fig. 1 – 5,3 mm

OZ-5351-11 **OZ-5351-61** **OZ-5351-81**

Fig. 2 – 6 mm

OZ-5351-12 **OZ-5351-62** **OZ-5351-82**

Fig. 3 – 7,2 mm

OZ-5351-13 **OZ-5351-63** **OZ-5351-83**

Fig. 4 – 8,2 mm

OZ-5351-14 **OZ-5351-64** **OZ-5351-84**

Fig. 5 – 9,8 mm

OZ-5351-15 **OZ-5351-65** **OZ-5351-85**

Fig. 6 – 12 mm

OZ-5351-16 **OZ-5351-66** **OZ-5351-86**



VOLKMANN

17 cm – 6¾"



BRUNS

23 cm – 9"

Scharfe Löffel Bone Curettes



Fig. 000 – 3,3 mm
○ OZ-5352-30

Fig. 00 – 4,8 mm
○ OZ-5352-20

Fig. 0 – 5,8 mm
○ OZ-5352-10

Fig. 1 – 7,3 mm
○ OZ-5352-01

Fig. 2 – 8,3 mm
○ OZ-5352-02

Fig. 3 – 10,2 mm
○ OZ-5352-03

Fig. 4 – 11,8 mm
○ OZ-5352-04

Fig. 5 – 12,8 mm
○ OZ-5352-05

Fig. 6 – 14 mm
○ OZ-5352-06



BRUNS
17 cm – 6¾"



Fig. 0000 – 2,5 mm
○ OZ-5353-40

Fig. 000 – 2,8 mm
○ OZ-5353-30

Fig. 00 – 3,3 mm
○ OZ-5353-20

Fig. 0 – 3,7 mm
○ OZ-5353-10

Fig. 1 – 4,3 mm
○ OZ-5353-01

Fig. 2 – 4,8 mm
○ OZ-5353-02

Fig. 3 – 5,6 mm
○ OZ-5353-03

Fig. 4 – 6,1 mm
○ OZ-5353-04

Fig. 5 – 6,7 mm
○ OZ-5353-05

Fig. 6 – 8,8 mm
○ OZ-5353-06



SPRATT
17 cm – 6¾"

Scharfe Löffel Bone Curettes

2 mm
 17 cm – 6¾"
OZ-5354-22



2 mm
 17 cm – 6¾"
OZ-5354-42



3 mm
 17 cm – 6¾"
OZ-5354-23



3 mm
 17 cm – 6¾"
OZ-5354-43



4 mm
 17 cm – 6¾"
OZ-5354-24



4 mm
 17 cm – 6¾"
OZ-5354-44



5 mm
 19,5 cm – 7¾"
OZ-5354-25



5 mm
 19,5 cm – 7¾"
OZ-5354-45



Fig. 000 – 3 mm



OZ-5355-30

6 mm
 19,5 cm – 7¾"
OZ-5354-26



6 mm
 19,5 cm – 7¾"
OZ-5354-46



Fig. 00 – 4 mm



OZ-5355-20

7 mm
 19,5 cm – 7¾"
OZ-5354-27



7 mm
 19,5 cm – 7¾"
OZ-5354-47



Fig. 0 – 5 mm



OZ-5355-10

schwedisches
 Modell
 swedish
 pattern



8 mm
 20 cm – 8"
OZ-5354-28



8 mm
 20 cm – 8"
OZ-5354-48



Fig. 1 – 6 mm



OZ-5355-01

10 mm
 20,5 cm – 8"
OZ-5354-30



10 mm
 21 cm – 8¼"
OZ-5354-50

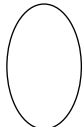

Fig. 2 – 7 mm



OZ-5355-02

12 mm
 20,5 cm – 8"
OZ-5354-32



12 mm
 21,5 cm – 8½"
OZ-5354-52

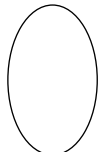
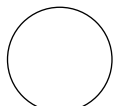

Fig. 3 – 8 mm



OZ-5355-03

14 mm
 20,5 cm – 8"
OZ-5354-34



14 mm
 22 cm – 8¾"
OZ-5354-54

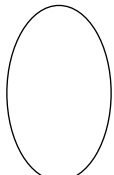

SCHEDE
 17 cm – 6¾"



Fig. 4 – 9 mm

OZ-5355-04



Scharfe Löffel Bone Curettes



WILLIGER

17,5 cm – 7"

Fig. 00 – 2,5 mm



OZ-5356-20

Fig. 0 – 3,2 mm



OZ-5356-10

Fig. 1 – 4 mm



OZ-5356-01

Fig. 2 – 5,7 mm



OZ-5356-02



UFFENRODE

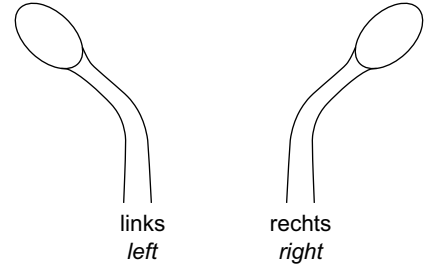

links
left

rechts
right

17 cm – 6¾"

OZ-5357-01

OZ-5357-02



VOLKMANN

28 cm – 11"

Fig. 0 – 4,4 mm



OZ-5358-10

Fig. 1 – 6,8 mm



OZ-5358-01

Fig. 2 – 8,5 mm



OZ-5358-02

Fig. 3 – 10 mm



OZ-5358-03



DAUBENSPECK

20 cm – 8"

Fig. 00 – 2,8 mm



OZ-5361-20

Fig. 0 – 3,6 mm



OZ-5361-10

Fig. 1 – 4,4 mm



OZ-5361-01

Fig. 2 – 5,2 mm



OZ-5361-02

Scharfe Löffel Bone Curettes



19 cm – 7½"



gerade, keramikbeschichtet
straight, ceramic coated

19 cm – 7½"

Fig. 000

OZ-5363-101



19 cm – 7½"

Fig. 0

OZ-5363-103



gebogen, keramikbeschichtet
curved, ceramic coated

19 cm – 7½"

Fig. 000

OZ-5363-111



19 cm – 7½"

Fig. 0

OZ-5363-113



rückwärts gebogen, keramikbeschichtet
reverse curved, ceramic coated

19 cm – 7½"

Fig. 000

OZ-5363-301

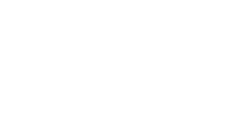

19 cm – 7½"

Fig. 0

OZ-5363-303



Scharfe Löffel Bone Curettes

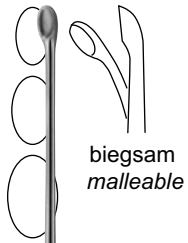

HALLÉ
21 cm – 8¼"

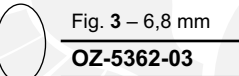
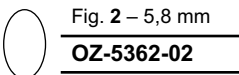
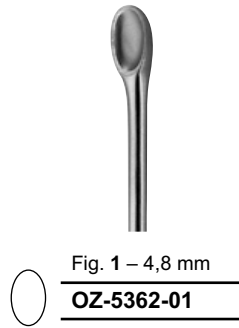

Fig. 000 – 3,6 mm
25 cm – 10"

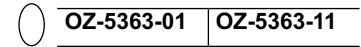

Fig. 00 – 4,4 mm
25 cm – 10"

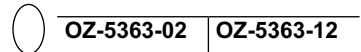

Fig. 0 – 5,2 mm
25 cm – 10"

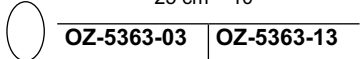
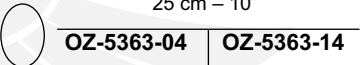

Fig. 1 – 6 mm
25 cm – 10"



1:3



VOLKMANN

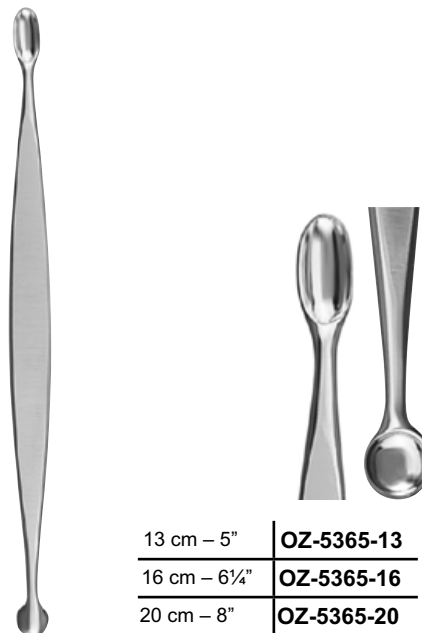

VOLKMANN



OZZE MEDICAL & SURGICAL SUPPLIES
TOOLS TO OPERATE

Scharfe Löffel Bone Currettes



Ø 3,1 / 2,6 mm

OZ-5366-00



Ø 3 / 2,5 mm

OZ-5368-00



Ø 4,2 / 3,1 mm

OZ-5366-01



Ø 3,5 / 3 mm

OZ-5368-01



Ø 4,8 / 4,2 mm

OZ-5366-12



Ø 4,2 / 3,5 mm

OZ-5368-12



Ø 4 / 3,5 mm

OZ-5369-13

MARTINI

13,5 cm – 5¼"

WILLIGER

13,5 cm – 5¼"

JACOBSON

13 cm – 5"



Ø 4,5 / 3,5 mm

OZ-7921-15

JANSEN

15 cm – 6"



Ø 6,5 / 6,2 mm

OZ-5370-21

WILLIGER

20,5 cm – 8"



Knochenraspeln Bone Rasps

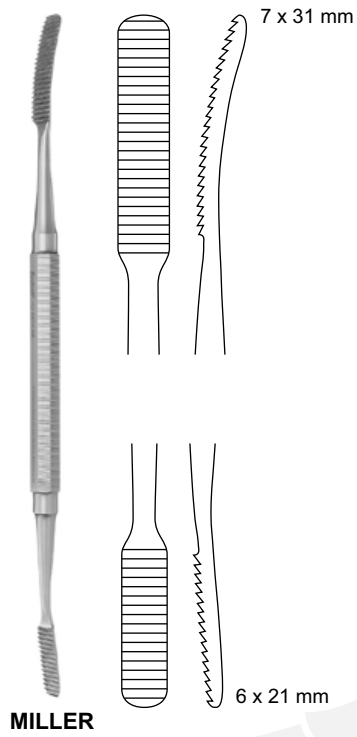

18 cm – 7"
OZ-5374-02



30 cm – 11¼"
OZ-5375-30



27 cm – 10½"
OZ-5376-27



25 cm – 10"
OZ-5377-25



24 cm – 9½"
OZ-5378-24



22 cm – 8¾"
OZ-5379-22



Raspatorien Raspatories



scharf
sharp

19 cm – 7½"

OZ-5379-19

MOLT



12,5 mm



gerade
straight



gebogen
curved

15 cm – 6"

OZ-5380-15

OZ-5381-15

FARABEUFG



18 mm

scharf
sharp

18,5 cm – 7¼"

OZ-5382-18

SEDILLOT



15 mm

scharf
sharp

21,5 cm – 8½"

OZ-5382-21

SEDILLOT



Raspatorien Raspatories



LANGENBECK



16 mm
scharf,
leicht gebogen
*sharp,
slightly curved*

19 cm – 7½"

OZ-5384-18



CUSHING

15 mm



rund, scharf,
leicht gebogen
*round, sharp,
slightly curved*



eckig, scharf,
leicht gebogen
*square, sharp,
slightly curved*

18 cm – 7"

OZ-5384-30

OZ-5384-31



LAMBOTTE



scharf,
leicht gebogen
*sharp,
slightly curved*

21,5 cm – 8½"

5 mm	OZ-5385-05
10 mm	OZ-5385-10
15 mm	OZ-5385-15
20 mm	OZ-5385-20
25 mm	OZ-5385-25



SCHNEIDER-SAUERBRUCH



13 mm

scharf, gebogen
sharp, curved

19 cm – 7½"

OZ-5386-19



Raspatorien Raspatories



12 mm

20 cm – 8"

OZ-5387-20

ALEXANDER



JANSEN



15 mm

scharf,
leicht gebogen
*sharp,
slightly curved*

16,5 cm – 6½"

OZ-5388-16



13 mm

20 cm – 8"

OZ-5389-19

SELDIN

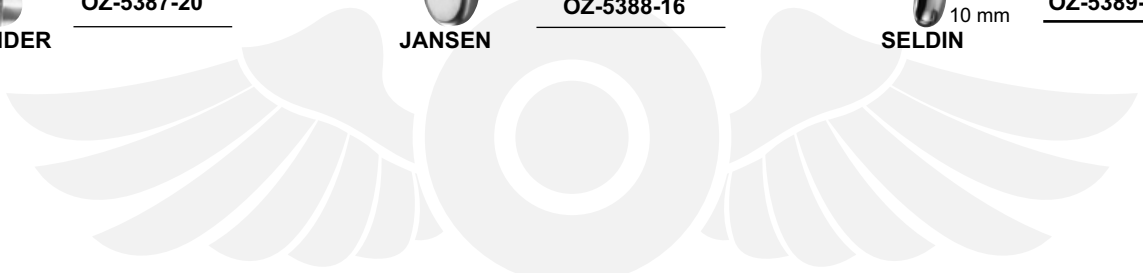

WILLIGER

5 mm

scharf, gebogen
sharp, curved

12,5 cm – 5"

OZ-5390-13



KÖNIG

5 mm

scharf, gebogen
sharp, curved

15,5 cm – 6"

OZ-5391-15



WILLIGER

6,5 mm

scharf, gebogen
sharp, curved

16 cm – 6¼"

OZ-5392-16

Raspatorien Raspatories



JOSEPH

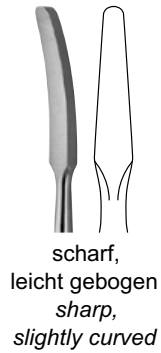

scharf,
leicht gebogen
*sharp,
slightly curved*

16,5 cm – 6½"

OZ-8206-16



COTTLE



scharf,
leicht gebogen
*sharp,
slightly curved*

19,5 cm – 7¾"

OZ-8210-19

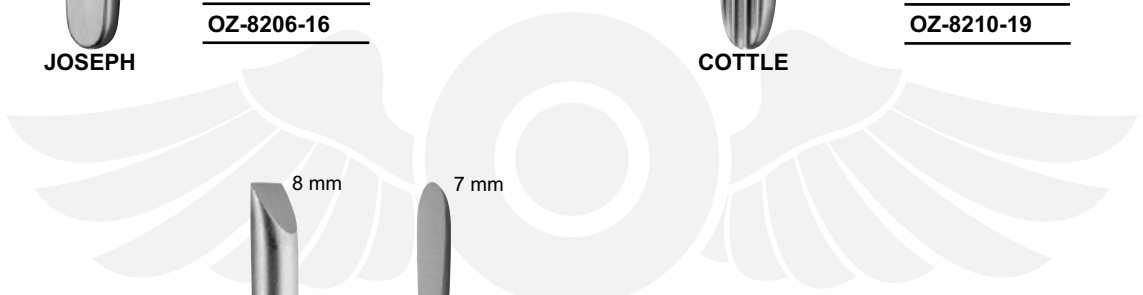

scharf
sharp



scharf
sharp

17 cm – 6¾"

OZ-5393-01

OZ-5393-03



ADSON



stumpf
blunt



scharf
sharp

17 cm – 6¾"

OZ-5393-02

OZ-5393-04



6 mm **OZ-5394-06**

8 mm **OZ-5394-08**



scharf, gebogen
sharp, curved

17 cm – 6¾"



Raspatorien Raspatories



SEMBA

	12 mm	12 mm	12 mm	13 mm	13 mm	15 mm	15 mm
19,5 cm – 7¾"	21 cm – 8¼"	18 cm – 7"	20 cm – 8"	21,5 cm – 8½"	22 cm – 8¾"	22 cm – 8¾"	
OZ-5398-01	OZ-5398-02	OZ-5398-03	OZ-5398-04	OZ-5398-05	OZ-5398-06	OZ-5398-07	



DOYEN

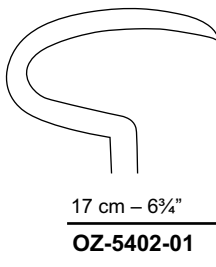
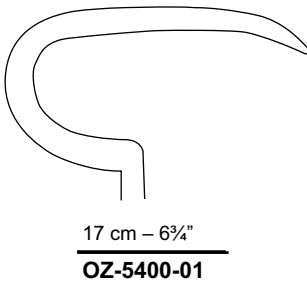

DOYEN

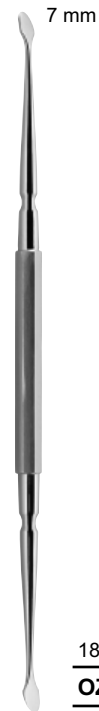
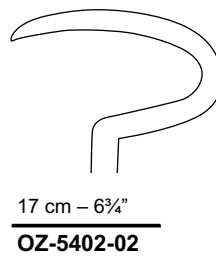
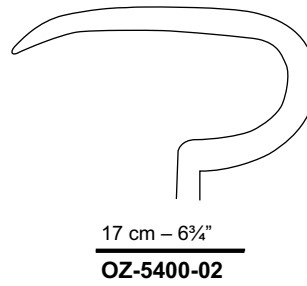

SYME

18 cm – 7"
OZ-5407-01



Raspatorien Raspatories



	24 cm – 9½"	
4 mm	OZ-5409-01	–
6 mm	OZ-5409-02	–
8 mm	OZ-5409-03	–
10 mm	–	OZ-5409-24
13 mm	–	OZ-5409-25
19 mm	–	OZ-5409-27
25 mm	–	OZ-5409-29

1:3
COBB

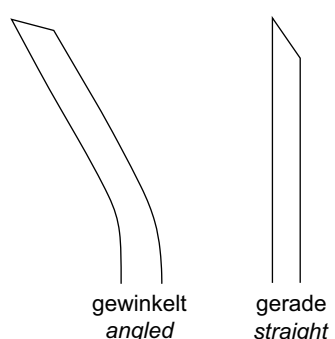
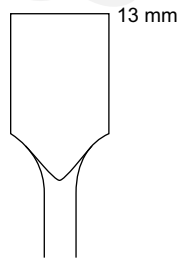
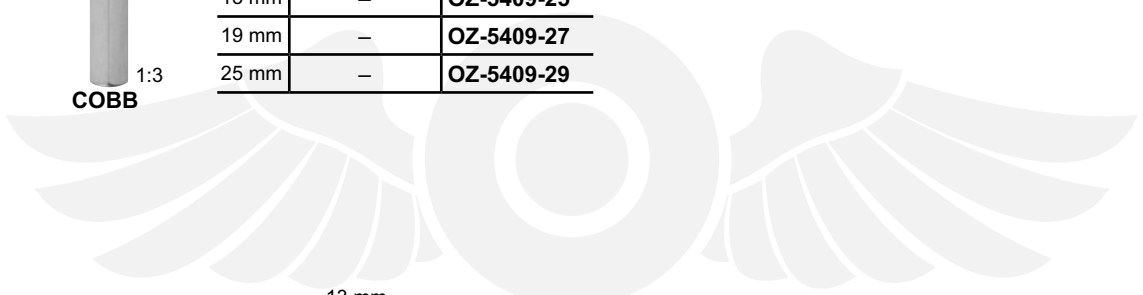

19 cm – 7½"	
OZ-5410-05	OZ-5410-15

Instrumente mit **Propylux** Griffen

Ein hochstabiles Thermoplast mit wesentlich besseren Eigenschaften als das oft verwendete Ferrozell:

Exzellente Resistenz gegen Säuren und Laugen, daher hygienisch unbedenklicher als Ferrozell Hohe Formstabilität auch nach Hunderten von

Steri-Zyklen

Hohe Festigkeit auch bei extremer Beanspruchung

Hohe Farbbeständigkeit

Enorme Reduzierung von Reparaturen

Zugelassen bei der FDA

Geeignet für alle Sterilisationsverfahren

Instruments with **Propylux** Handles

A highly resistant thermoplastic having much better characteristics than the often used Ferrozell:

Excellent resistance against acids and leaches, therefore much safer than Ferrozell from the hygiene point of view

High form stability even after hundreds of sterilisation cycles

High solidity even when exposed to extreme loads

Highly colour-fast

Tremendously reduced need of repair

FDA approved

Suitable for all sterilisation procedures



Raspatorien Raspatories

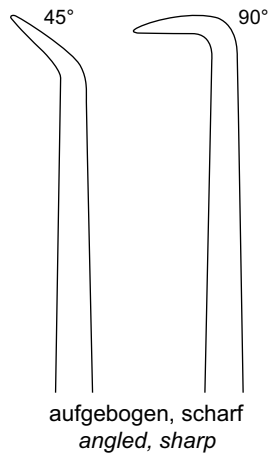
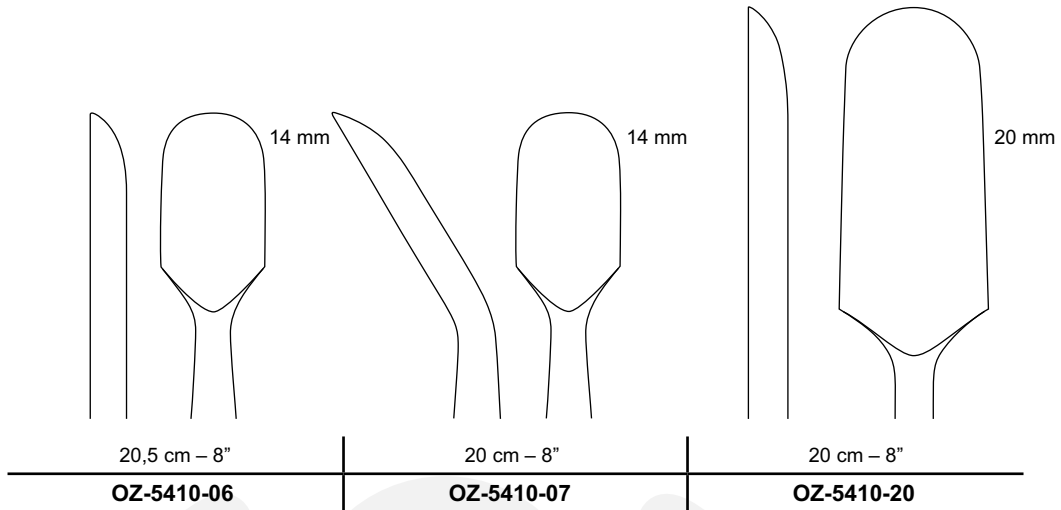

43 cm – 17"	OZ-5417-01	OZ-5417-02
-------------	-------------------	-------------------

1:4



Stahl-Griff
Steel handle

COBB 1:3



scharf, gebogen
sharp, curved

29 cm – 11½"	
10 mm	OZ-5412-50
13 mm	OZ-5412-51
19 mm	OZ-5412-54
25 mm	OZ-5412-57
32 mm	OZ-5412-60



Raspatorien und Elevatorien Raspatories and Elevators

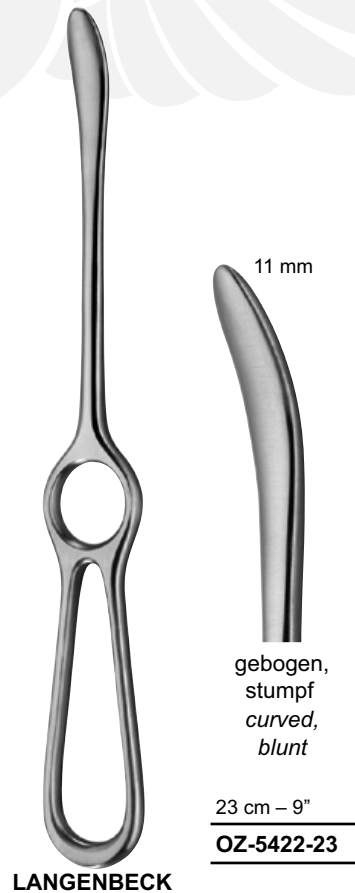
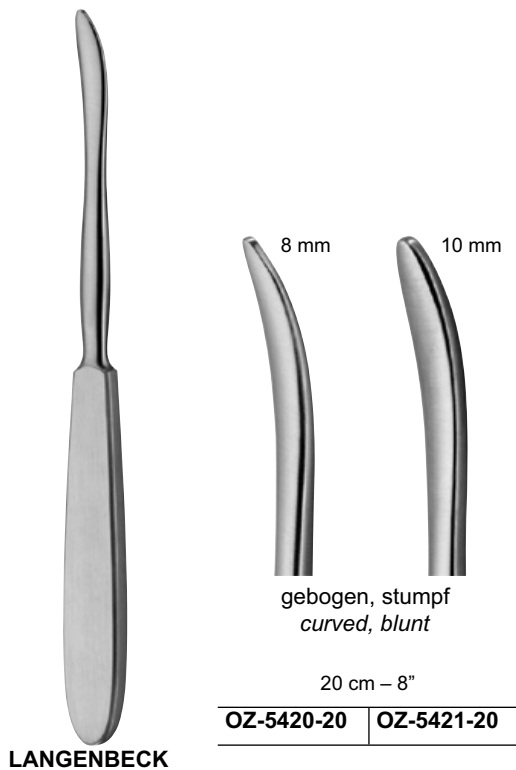
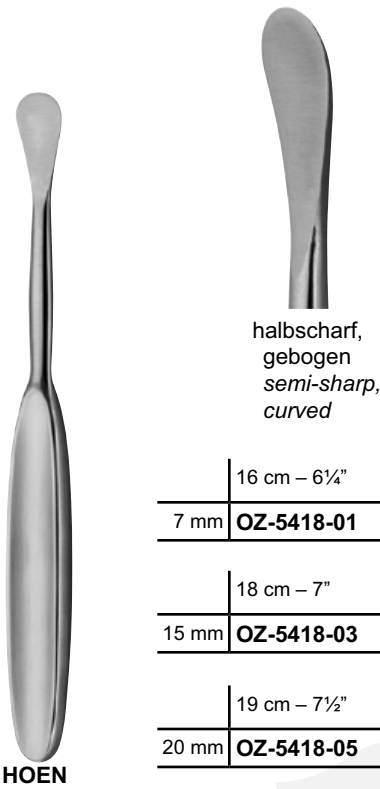

Elevatoren Elevators

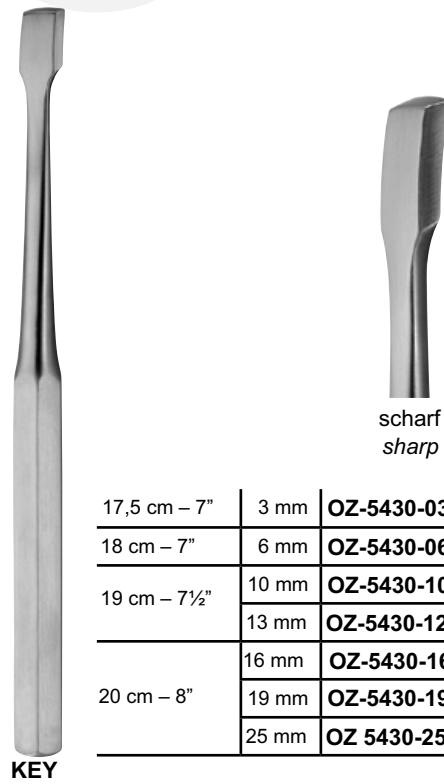
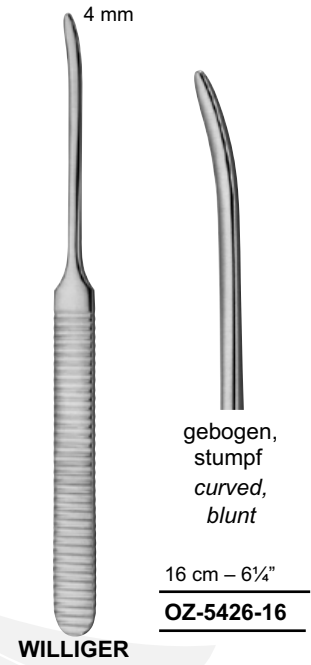
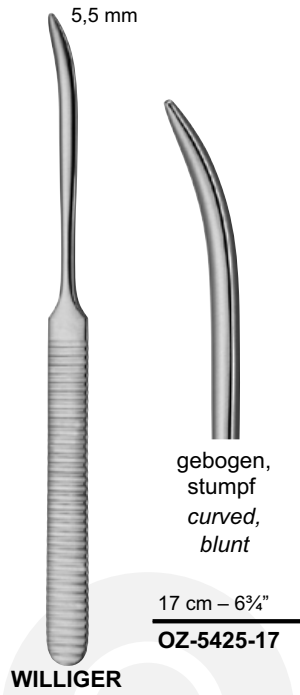



OZZE MEDICAL & SURGICAL SUPPLIES
TOOLS TO OPERATE

Elevatorien Elevators

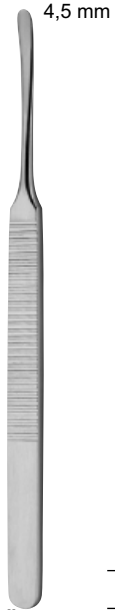

4,5 mm

KÖNIG

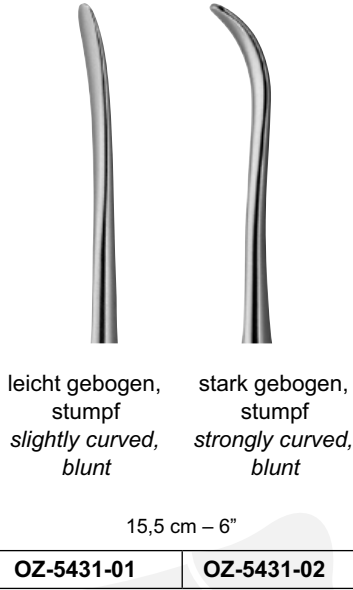

leicht gebogen,
stumpf
*slightly curved,
blunt*

stark gebogen,
stumpf
*strongly curved,
blunt*

15,5 cm – 6"

OZ-5431-01

OZ-5431-02

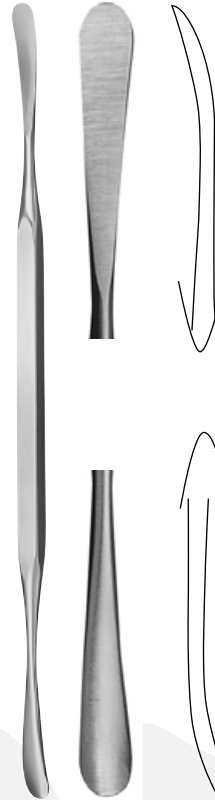

6,5 mm
scharf
sharp

6,5 mm
stumpf
blunt

21 cm – 8¼"

OZ-5432-21

ALDERDYCE

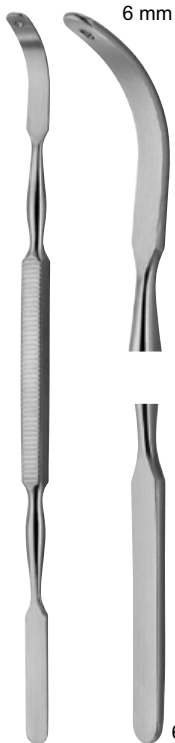

6 mm

MC DONALD

stumpf / stumpf
blunt / blunt

18,5 cm – 7¼"

OZ-5434-19

6 mm

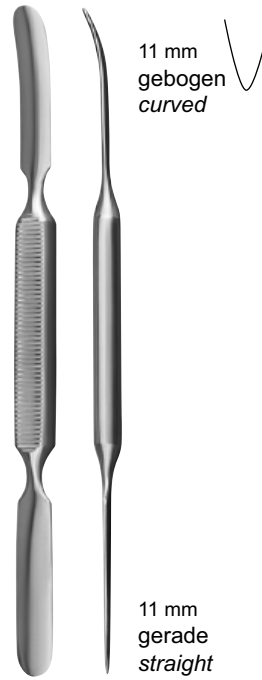

11 mm
gebogen
curved

11 mm
gerade
straight

17,5 cm – 7"

OZ-5435-17

WATSON-CHEYNE



Knochenheber Bone Levers

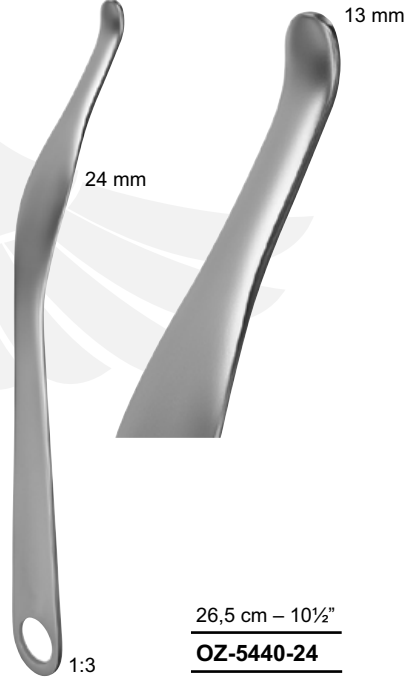



OZZE MEDICAL & SURGICAL SUPPLIES
TOOLS TO OPERATE

Knochenheber Bone Levers

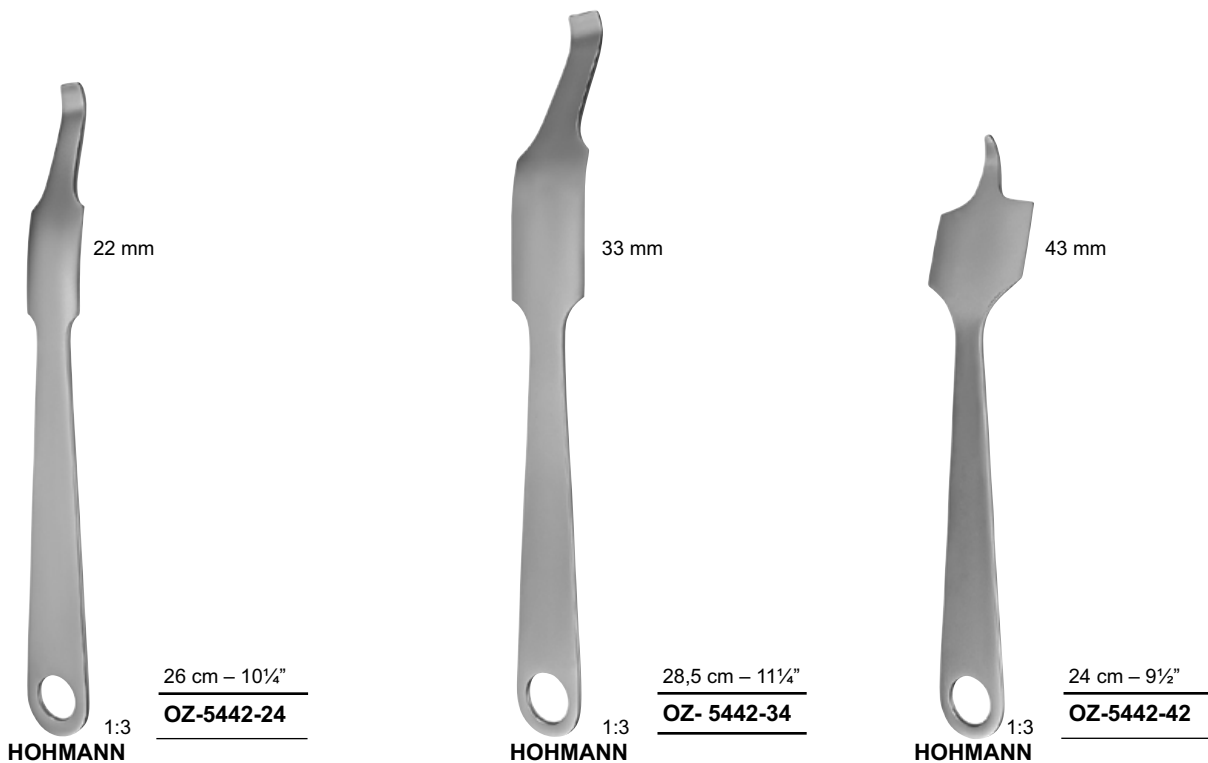
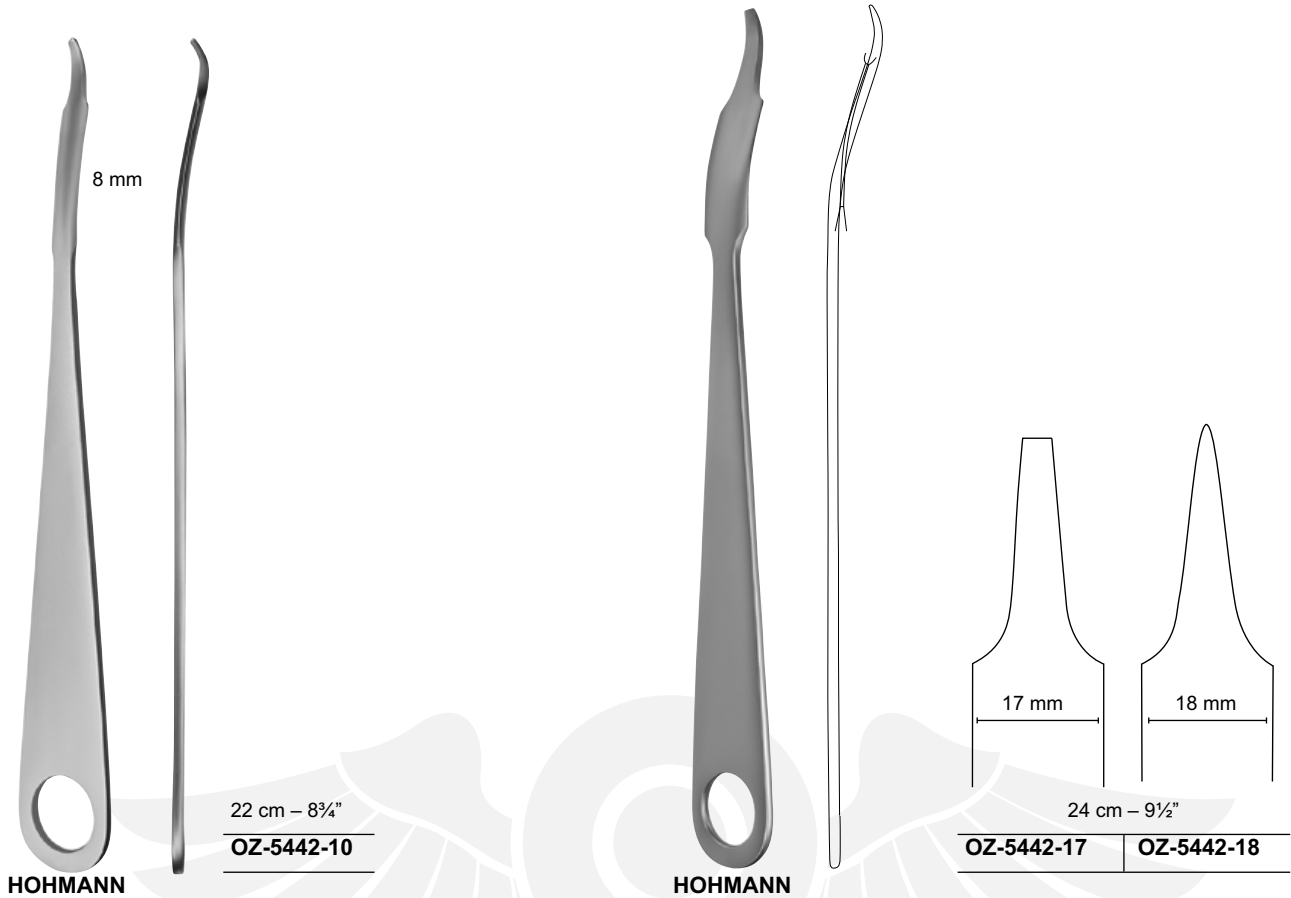



Knochenheber
Bone Levers

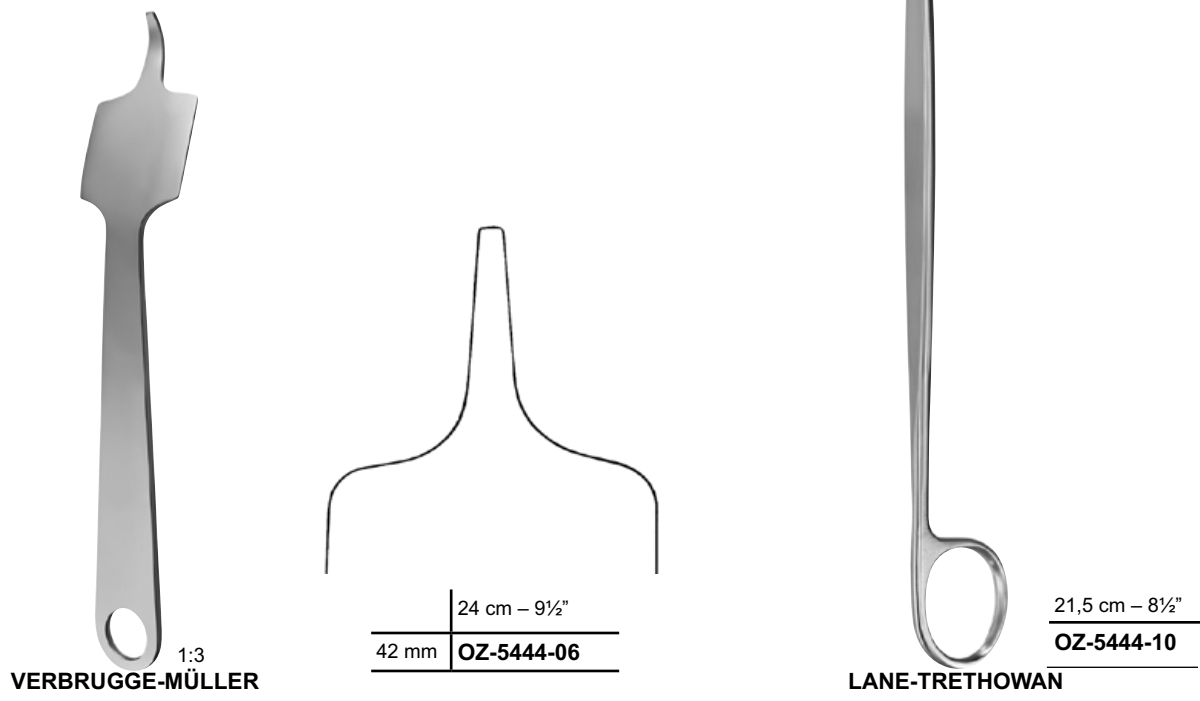
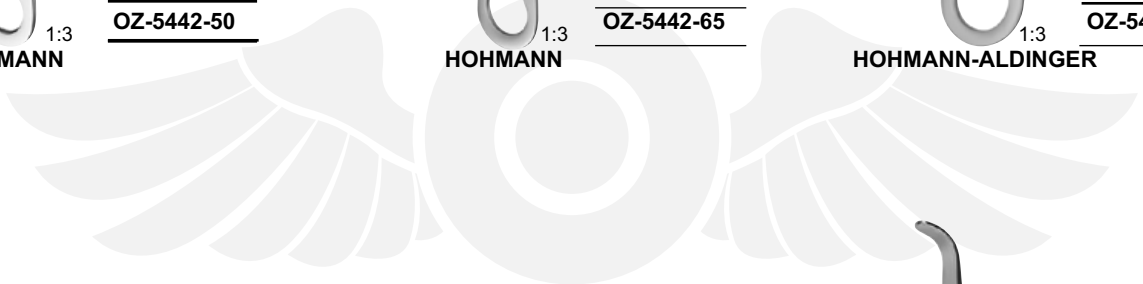
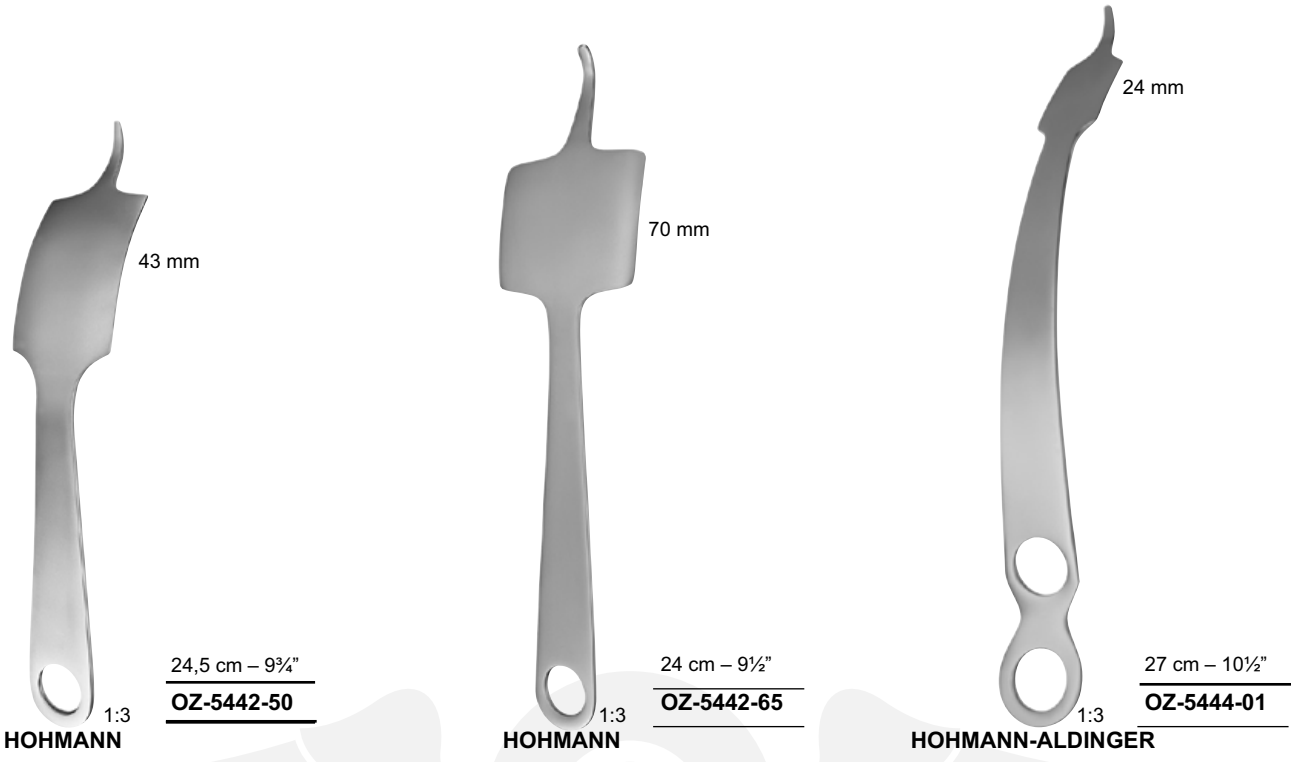



Knochenhebel Bone Levers



BRISTOW 1:3

23 cm – 9"
OZ-5444-12



MURPHY-LANE 1:3

32 cm – 12½"
OZ-5445-32



BLOUNT 1:3

38 mm

26 cm – 10¼"
OZ-5447-01



BLOUNT 1:3

42 mm

26 cm – 10¼"
OZ-5447-02



BENNETT 1:3

24 cm – 9½"

44 mm **OZ-5450-44**
60 mm **OZ-5450-64**



Knochenhaken Bone Retractors



VOLKMANN

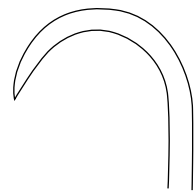

scharf
sharp

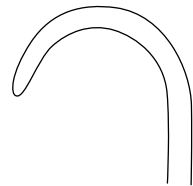

stumpf
blunt

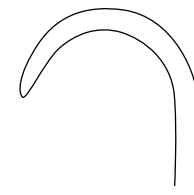

halbscharf
semi-sharp

22 cm – 8³/₄"

OZ-4500-01	OZ-4501-01	OZ-4503-01
-------------------	-------------------	-------------------



VOLKMANN

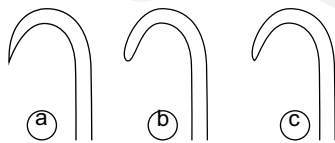

- (a) scharf / sharp
- (b) stumpf / blunt
- (c) halbscharf / semi-sharp

9 x 8 mm



9 x 13 mm



9 x 19 mm



22 cm – 8³/₄"

(a) scharf / sharp	OZ-4500-02	OZ-4500-03	OZ-4500-04
(b) stumpf / blunt	OZ-4501-02	OZ-4501-03	OZ-4501-04
(c) halbscharf / semi-sharp	OZ-4502-02	OZ-4502-03	OZ-4502-04

9 x 29 mm



9 x 40 mm



22 cm – 8³/₄"

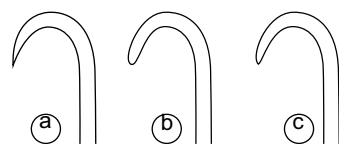

- (a) scharf / sharp
- (b) stumpf / blunt
- (c) halbscharf / semi-sharp

(a) scharf / sharp	OZ-4500-06	OZ-4500-08
(b) stumpf / blunt	OZ-4501-06	OZ-4501-08
(c) halbscharf / semi-sharp	OZ-4502-06	OZ-4502-08



OZZE MEDICAL & SURGICAL SUPPLIES
TOOLS TO OPERATE

Knochenhaken Bone Retractors



scharf
sharp

24 cm – 9½"

OZ-4506-24



KOCHER



KOCHER



scharf
sharp

21,5 cm – 8½"

OZ-4506-01



KOCHER



KOCHER



scharf
sharp

21,5 cm – 8½"

OZ-4507-01



scharf
sharp

21,5 cm – 8½"

OZ-4507-11

Knochenhaken Bone Retractors

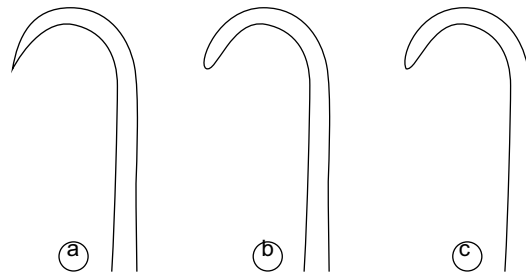

15 x 10 mm

15 x 15 mm

20 x 18 mm



KOCHER



22,5 cm – 8¾"

(a) scharfsharp (b) stumpfblunt (c) halbscharf-semi-sharp				
		OZ-4506-02	OZ-4506-03	OZ-4506-04
		OZ-4507-02	OZ-4507-03	OZ-4507-04
	OZ-4508-02	OZ-4508-03	OZ-4508-04	

15 x 30 mm

15 x 40 mm



22,5 cm – 8¾"

(a) scharfsharp (b) stumpfblunt (c) halbscharf-semi-sharp			
		OZ-4506-06	OZ-4506-08
		OZ-4507-06	OZ-4507-08
	OZ-4508-06	OZ-4508-08	

Spinalhaken, Meniskusmesser
Spinal Retractors, Meniscus Knives

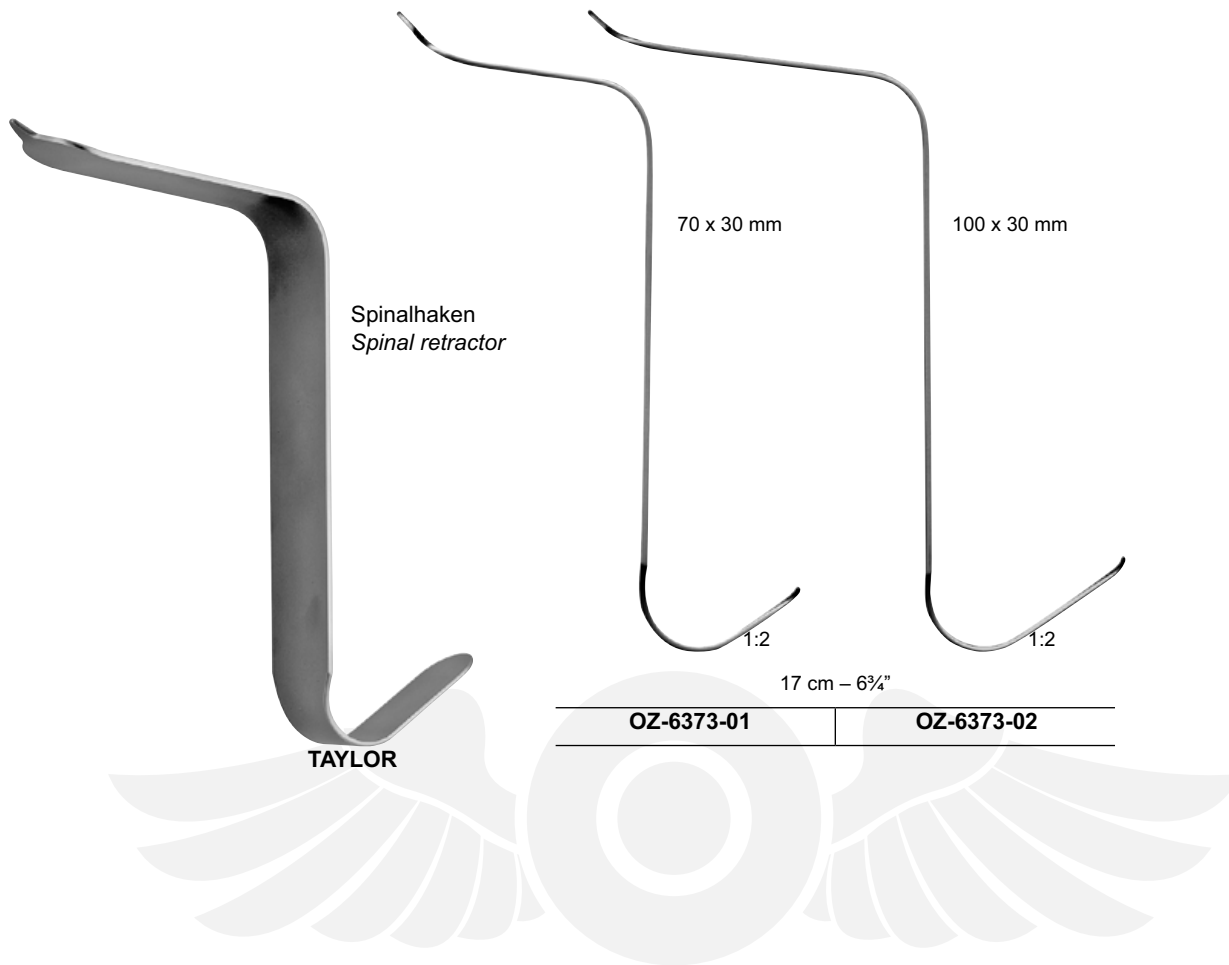

OZ-6373-01	OZ-6373-02
-------------------	-------------------

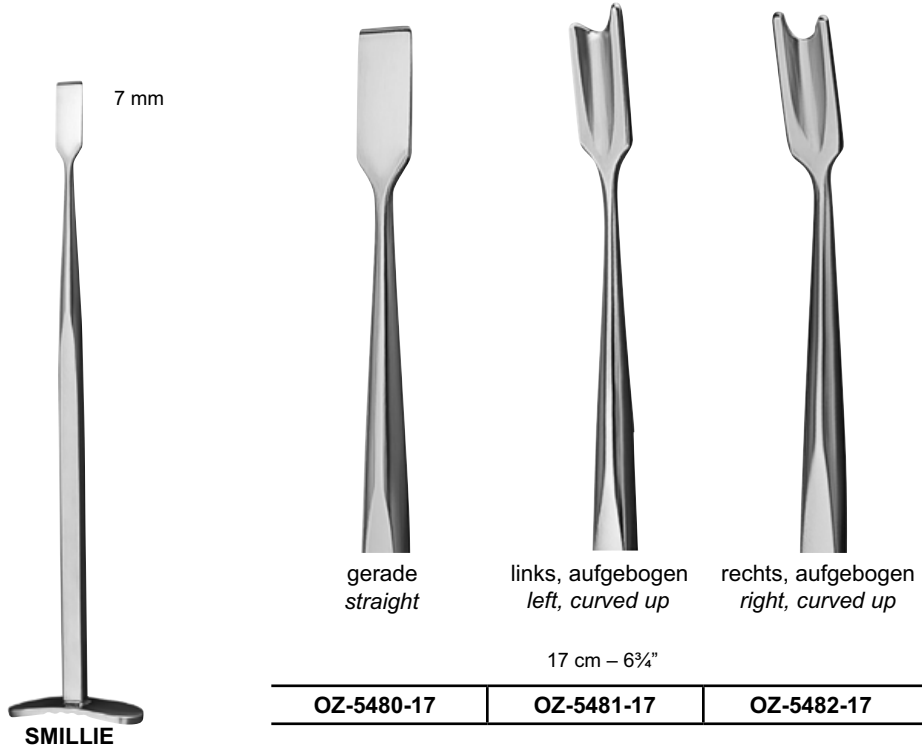

OZ-5480-17	OZ-5481-17	OZ-5482-17
-------------------	-------------------	-------------------

Knochenhaltezangen Bone Holding Forceps



Sequesterzange
Sequestrum forceps

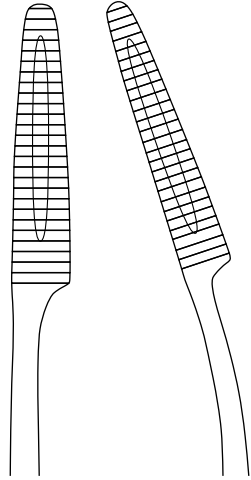

gerade
straight

aufgebogen
curved up

20 cm – 8"

OZ-5500-20

OZ-5501-20

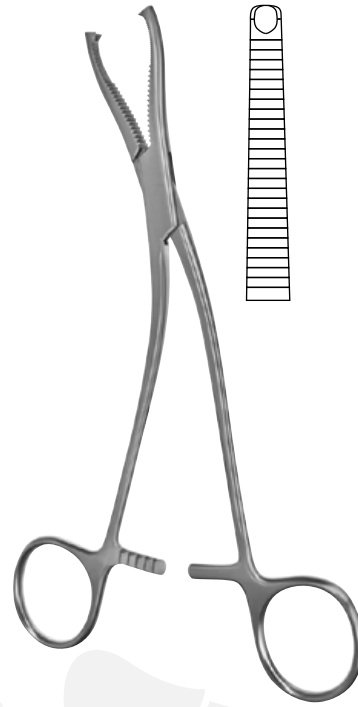

19 cm – 7½"

OZ-5505-19

DINGMANN

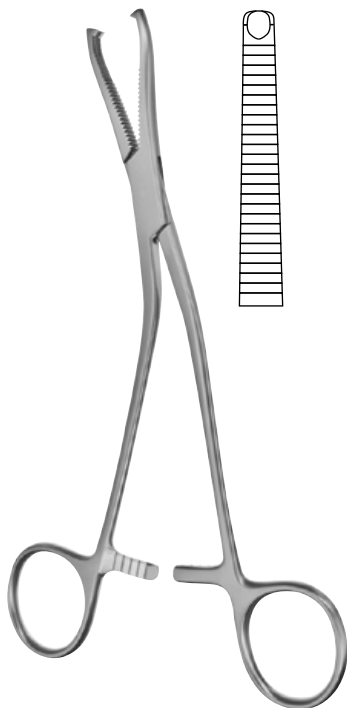

19 cm – 7½"

OZ-5506-19

DINGMANN (modif.)

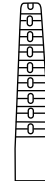
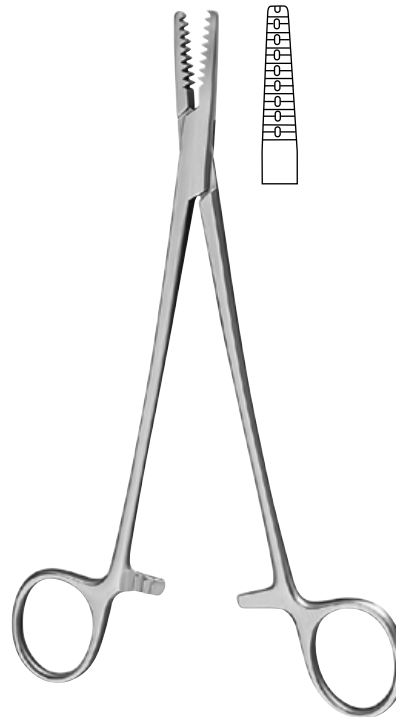

19 cm – 7½"

OZ-5508-19

MARTIN



OZZE MEDICAL & SURGICAL SUPPLIES
TOOLS TO OPERATE

Knochenhaltezangen Bone Holding Forceps



BIRCHER-GANSKE



gerade
straight



aufgebogen
curved up



seitlich gebogen
curved to side

20 cm – 8"

OZ-5510-00

OZ-5510-20

OZ-5511-20



LEWIN

17,5 cm – 7"

OZ-5512-17



LANGENBECK

12 mm



21 cm – 8¼"

OZ-5514-21



Knochenhaltezaugen Bone Holding Forceps



FERGUSSON

11 mm



21 cm – 8¼"

OZ-5516-21



16 cm – 6¼"

OZ-5518-16

24 cm – 9½"

OZ-5518-24



KERN

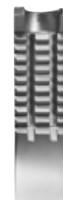

ohne Sperre
without ratchet

mit Sperre
with ratchet

17 cm – 6¾"

OZ-5520-17

OZ-5521-17

21 cm – 8¼"

OZ-5520-21

OZ-5521-21

Knochenhalte­zangen Bone Holding Forceps



18 cm – 7"	OZ-5522-18
23 cm – 9"	OZ-5522-23
25 cm – 10"	OZ-5522-25
28 cm – 11"	OZ-5522-28

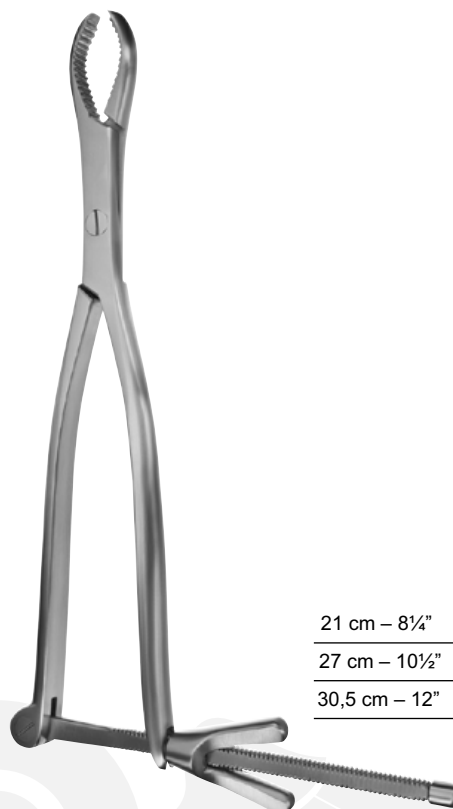

21 cm – 8¼"	OZ-5524-21
27 cm – 10½"	OZ-5524-27
30,5 cm – 12"	OZ-5524-30

HEY GROVES



8 mm

19 cm – 7½"	OZ-5525-19
-------------	-------------------

SEMB



7,5 mm

19 cm – 7½"	OZ-5525-51
-------------	-------------------

SEMB



Knochenhaltezangen Bone Holding Forceps

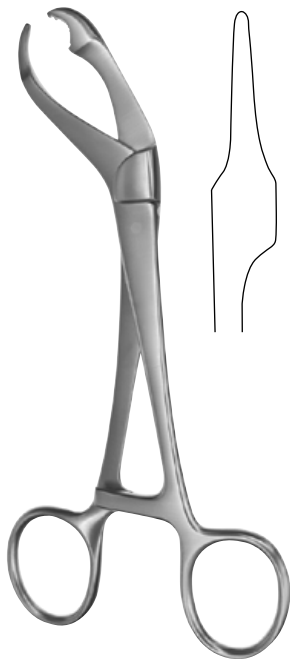

VERBRUGGE



kleines Modell
small pattern

17,5 cm – 7"

OZ-5527-17



VERBRUGGE



25 cm – 10"

OZ-5527-25



mit Lappenverschluss
with lip joint

26 cm – 10¼"

OZ-5527-26



27 cm – 10½"

OZ-5527-27



Knochenhaltezaugen Bone Holding Forceps



15 cm – 6"	OZ-5528-15
19 cm – 7½"	OZ-5528-19
24 cm – 9½"	OZ-5528-24
26 cm – 10¼"	OZ-5528-26
28 cm – 11"	OZ-5528-28



Amputationsretraktor,
Griffe abnehmbar
*Amputation retractor,
removeable handles*

PERCY
OZ-5529-30

1:4

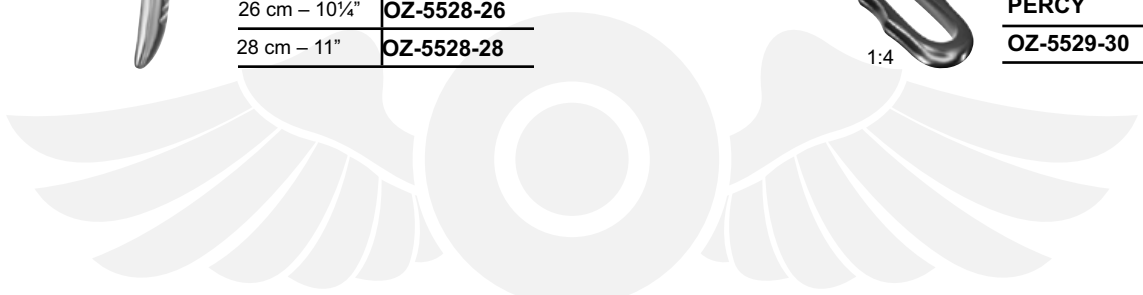

FARABEU-F-LAMBOTTE

26 cm – 10¼"
OZ-5533-26



LAMBOTTE

19 cm – 7½" | **OZ-5535-19**
23 cm – 9" | **OZ-5535-23**
26 cm – 10¼" | **OZ-5535-26**



OZZE MEDICAL & SURGICAL SUPPLIES
TOOLS TO OPERATE

Knochenhaltezangen Bone Holding Forceps



LANE

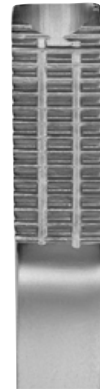

ohne Sperre mit Sperre
without ratchet *with ratchet*

33 cm – 13"	OZ-5534-33	OZ-5536-33
26 cm – 10¼"	OZ-5534-45	OZ-5536-45



14,5 cm – 5¾"
OZ-5537-14



13,5 cm – 5¼"
OZ-5538-12

Knochenhaltezaugen Bone Holding Forceps



13,5 cm – 5¼"
OZ-5539-13



20 cm – 8"
OZ-5539-20

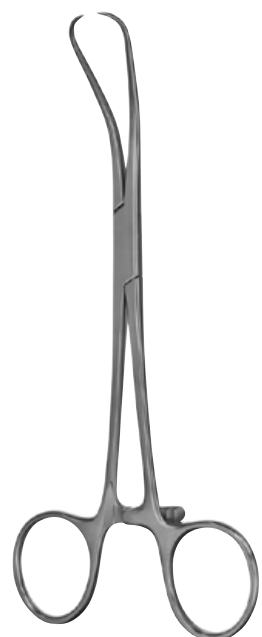

17 cm – 6¾"
OZ-5540-17



Patellazange
Patella forceps

17,5 cm – 7"
OZ-5540-01



Knochenhaltezangen Bone Holding Forceps



LOWMAN

18 cm – 7"	OZ-5542-18
20 cm – 8"	OZ-5542-20
22 cm – 8¾"	OZ-5542-22



MINI-LOWMAN

12 cm – 4¾"	OZ-5543-12
-------------	-------------------





OZZE MEDICAL & SURGICAL SUPPLIES
TOOLS TO OPERATE

Hohlmeißelzangen Bone Rongeurs



STELLBRINK



2 mm
leicht gebogen
slightly curved



2 mm
gebogen
curved

17 cm – 6¾"

OZ-5558-01

OZ-5558-02



BANE-HARTMANN



5 mm
gebogen
curved

17,5 cm – 7"

OZ-5559-17



MINI-FRIEDMANN

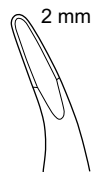

2 mm
gebogen
curved

12,5 cm – 5"

OZ-5560-12



LUER-FRIEDMANN



3 mm
leicht gebogen
slightly curved

14 cm – 5½"

OZ-5560-14

Hohlmeißelzangen Bone Rongeurs

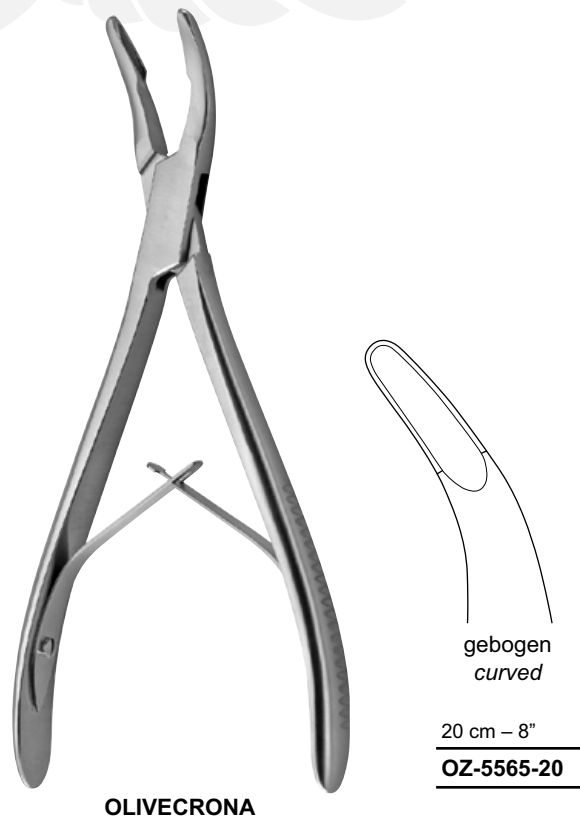
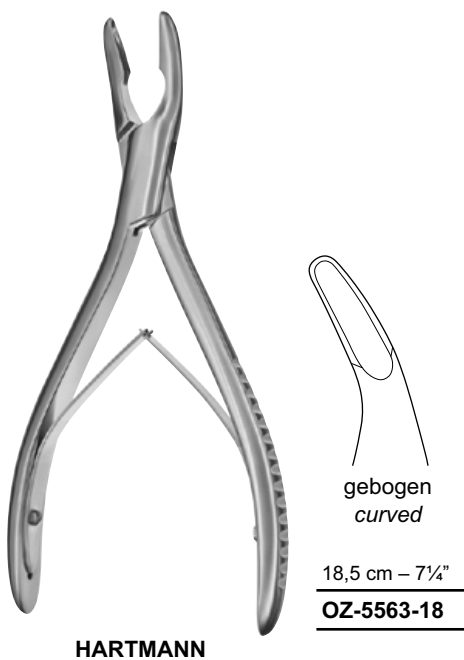
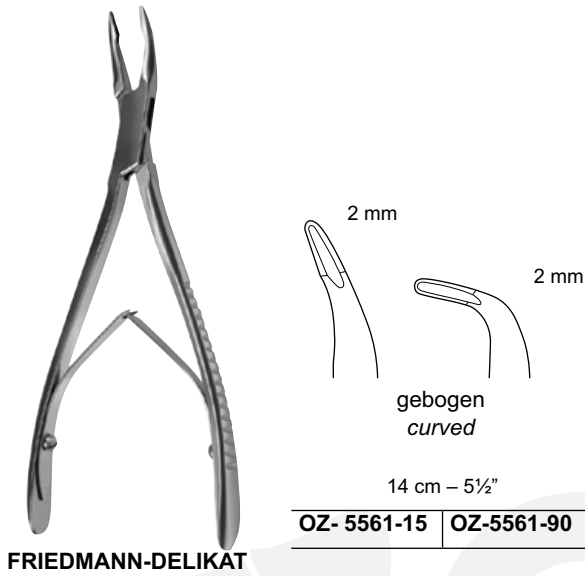



Hohlmeißelzangen Bone Rongeurs



4 mm

gebogen
curved

16,5 cm – 6½"

OZ-5566-16

MEAD

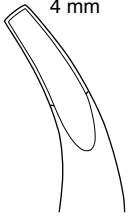

4 mm

gebogen
curved

16,5 cm – 6½"

OZ-5568-16



LEMPERT

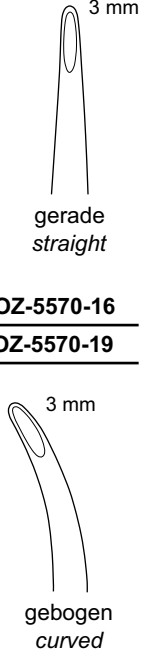

3 mm

gerade
straight

16 cm – 6¼" | **OZ-5570-16**
19 cm – 7½" | **OZ-5570-19**

3 mm

gebogen
curved

16 cm – 6¼" | **OZ-5571-16**
19 cm – 7½" | **OZ-5571-19**



3 mm

gebogen
curved

18 cm – 7"

OZ-5572-18

BEYER



4 mm

gerade
straight

17,5 cm – 7"

OZ-5573-17

4 mm

gebogen
curved

17,5 cm – 7"

OZ-5574-17

JANSEN



Hohlmeißelzangen Bone Rongeurs

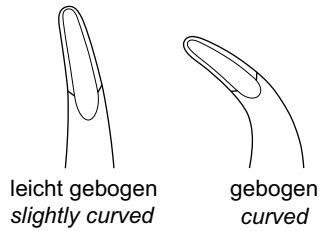

15,5 cm – 6"

OZ-5575-01

15 cm – 6"

OZ-5575-02

BLUMENTHAL

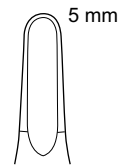

seitlich gebogen
curved laterally

16 cm – 6¼"

OZ-5576-15

HAKANSSON



4 mm

S-gebogen
S-curved

18 cm – 7"

OZ-5576-19

JANSEN

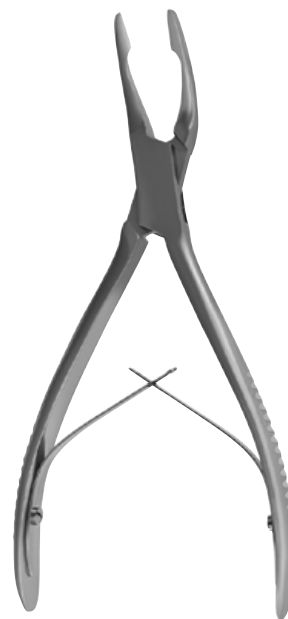

4 mm

gebogen
curved

17 cm – 6¾"

OZ-5579-01

COTTLE-JANSEN



Hohlmeißelzangen Bone Rongeurs

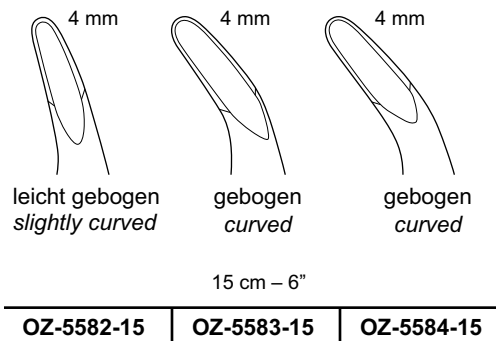
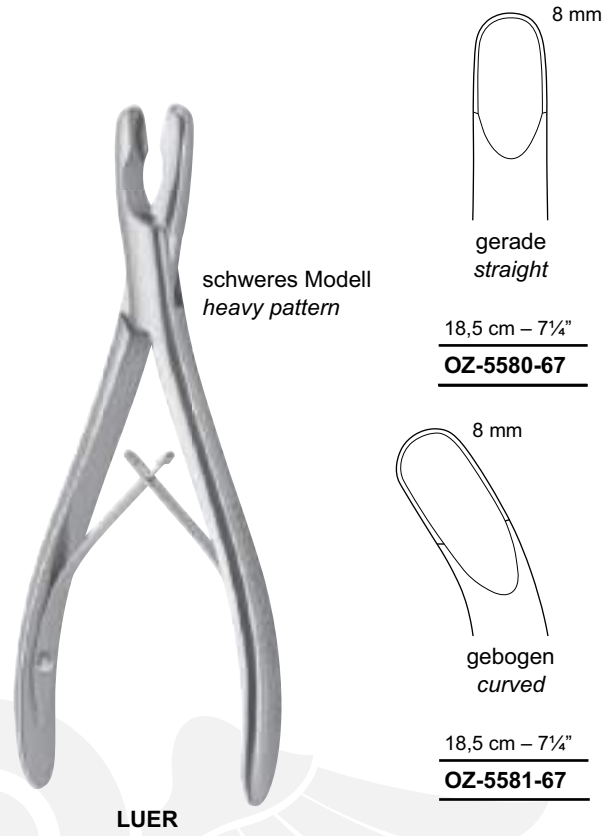
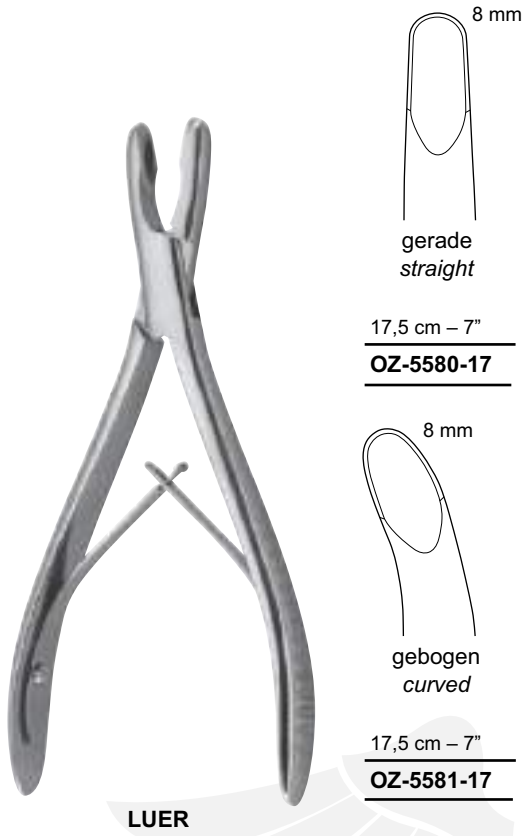



OZZE MEDICAL & SURGICAL SUPPLIES
TOOLS TO OPERATE

Hohlmeißelzangen Bone Rongeurs

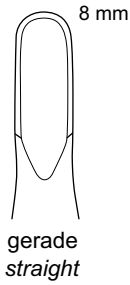
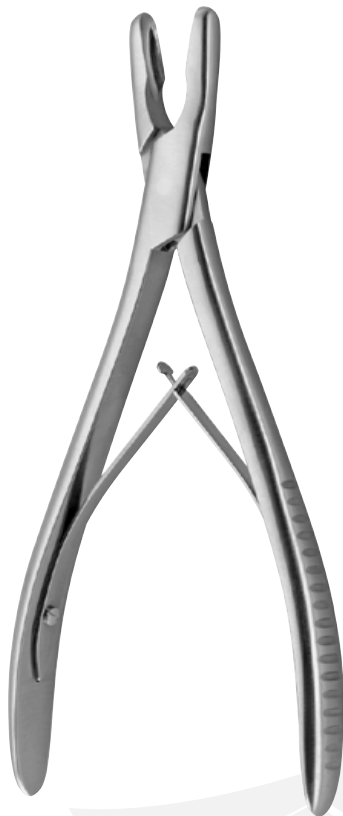

20,5 cm – 8"
OZ-5585-01

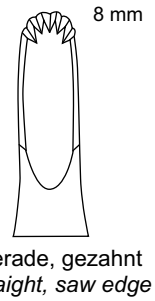
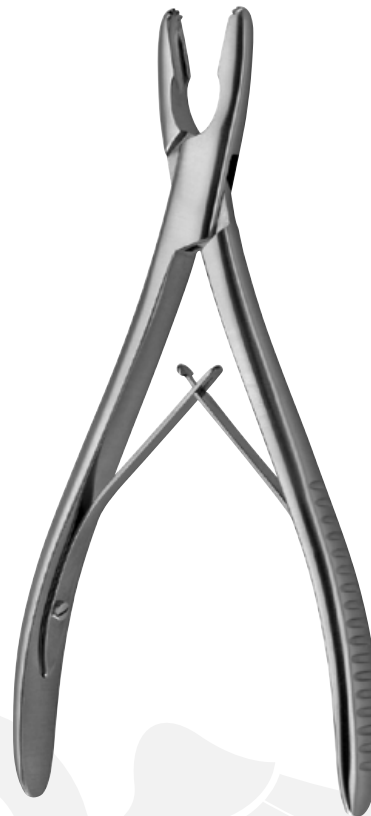

20,5 cm – 8"
OZ-5585-21

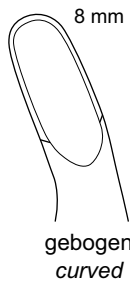

20,5 cm – 8"
OZ-5585-02

ADSON

ADSON

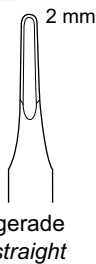

15 cm – 6"
OZ-5587-02



15 cm – 6"
OZ-5587-12

KLEINERT-KUTZ

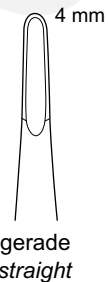

OZ-5588-15

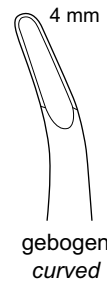

OZ-5589-15

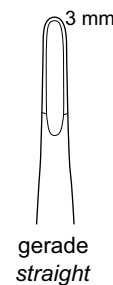

OZ-5588-03



OZ-5589-13

BÖHLER



OZZE MEDICAL & SURGICAL SUPPLIES
TOOLS TO OPERATE

Hohlmeißelzangen Bone Rongeurs



ZAUFAL-JANSEN

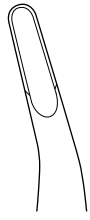

gebogen
curved

18 cm – 7"

OZ-5590-18



BEYER

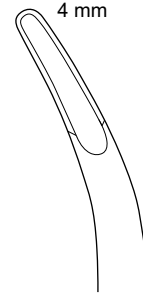

gebogen
curved

18 cm – 7"

OZ-5592-18



MAYFIELD

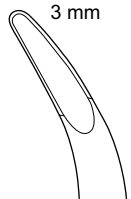

gebogen
curved

17,5 cm – 7"

OZ-5593-17



RUSKIN

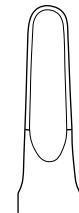

gerade
straight

18 cm – 7"

OZ-5594-02



Hohlmeißelzangen Bone Rongeurs



RUSKIN

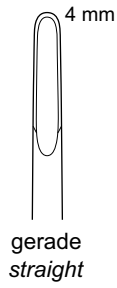

gerade
straight

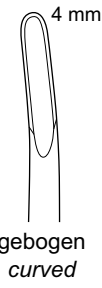

gebogen
curved

18 cm – 7"	OZ-5594-24	OZ-5594-34
------------	-------------------	-------------------

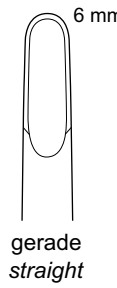

gerade
straight



gebogen
curved

18 cm – 7"	OZ-5594-51	OZ-5594-18
23,5 cm – 9¼"	OZ-5594-53	OZ-5594-23

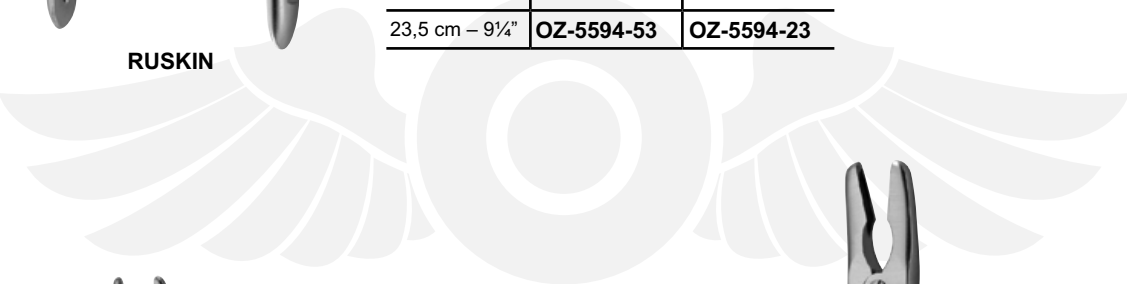

MARQUARDT



gebogen
curved

20 cm – 8"	OZ-5595-20
------------	-------------------



RÖTTGEN-RUSKIN

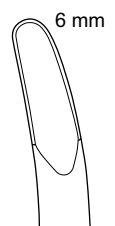

gebogen
curved

24 cm – 9½"	OZ-5596-24
-------------	-------------------



OZZE MEDICAL & SURGICAL SUPPLIES
TOOLS TO OPERATE

Hohlmeißelzangen Bone Rongeurs



SMITH-PETERSEN

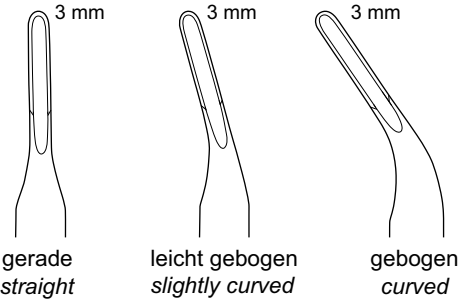

gerade
straight

leicht gebogen
slightly curved

gebogen
curved

24 cm – 9½"

OZ-5597-03	OZ-5597-13	OZ-5597-23
------------	------------	------------

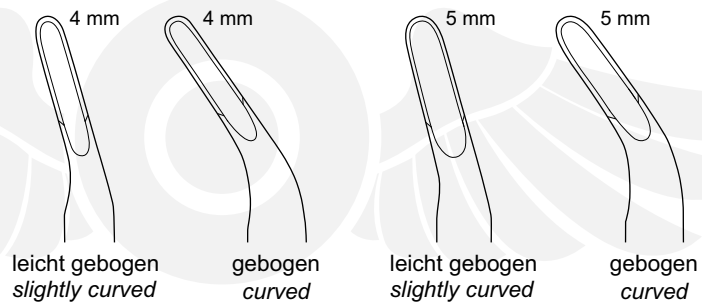

leicht gebogen
slightly curved

gebogen
curved

leicht gebogen
slightly curved

gebogen
curved

24 cm – 9½"

OZ-5597-14	OZ-5597-24	OZ-5597-15	OZ-5597-25
------------	------------	------------	------------



Hohlmeißelzangen Bone Rongeurs



STILLE-LUER

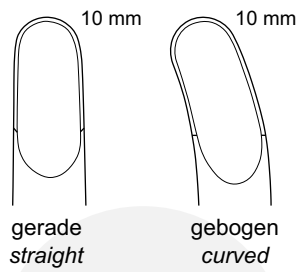

22 cm – 8 3/4"

OZ-5600-22

OZ-5601-22



STILLE-LUER

1:3

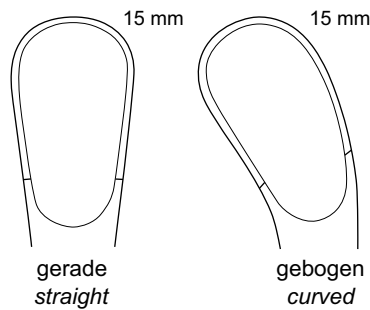

27 cm – 10 1/2"

OZ-5600-27

OZ-5601-27



OZZE MEDICAL & SURGICAL SUPPLIES
TOOLS TO OPERATE

Hohlmeißelzangen Bone Rongeurs

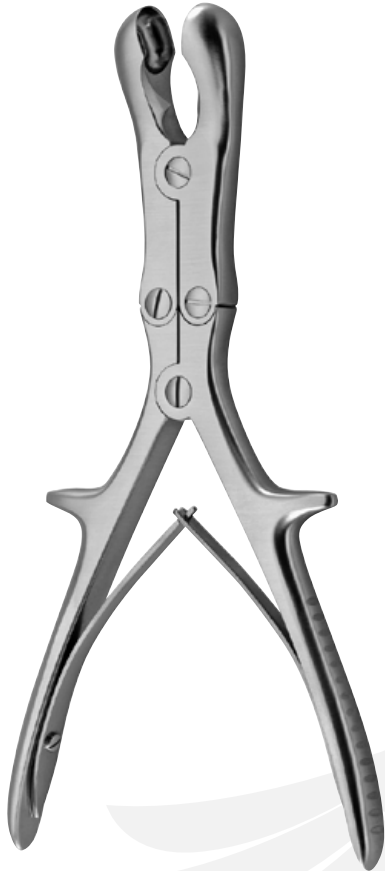

SEMB

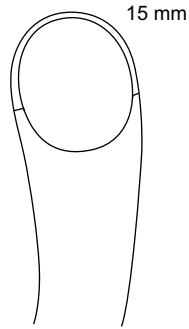

15 mm

gebogen
curved

23 cm – 9"

OZ-5602-23



STILLE-RUSKIN

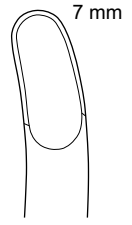

7 mm

gebogen
curved

24 cm – 9½"

OZ-5604-23



LEKSELL

1:3

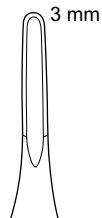

3 mm

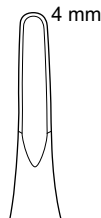

4 mm

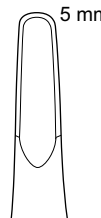

5 mm

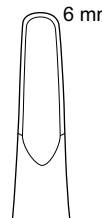

6 mm

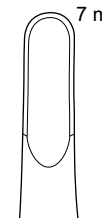

7 mm

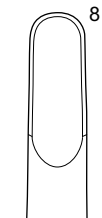

8 mm

seitlich gebogen
curved sideways

23,5 cm – 9¼"

OZ-5606-03	OZ-5606-04	OZ-5606-05	OZ-5606-06	OZ-5606-07	OZ-5606-08
-------------------	-------------------	-------------------	-------------------	-------------------	-------------------



OZZE MEDICAL & SURGICAL SUPPLIES
TOOLS TO OPERATE

Hohlmeißelzangen Bone Rongeurs



LEKSELL

1:3

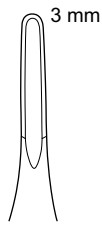

3 mm

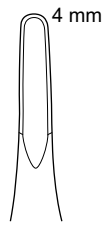

4 mm

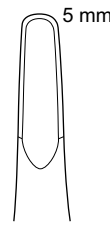

5 mm

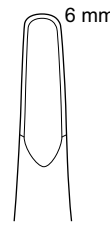

6 mm

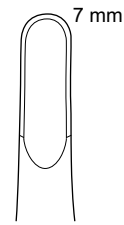

7 mm

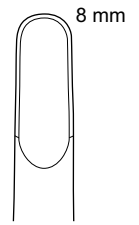

8 mm

seitlich gebogen
curved sideways

23 cm – 9"

OZ-5606-13	OZ-5606-14	OZ-5606-15	OZ-5606-16	OZ-5606-17	OZ-5606-18
------------	------------	------------	------------	------------	------------



STILLE

1:3

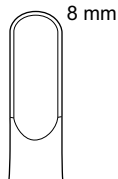

8 mm

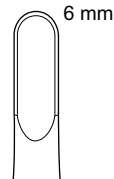

6 mm

seitlich gebogen
curved sideways

23 cm – 9"

OZ-5608-08	OZ-5608-23
------------	------------



OZZE MEDICAL & SURGICAL SUPPLIES
TOOLS TO OPERATE

Knochensplitterzangen Bone Cutting Forceps



LISTON



gerade
straight

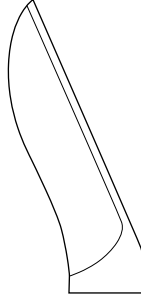

gebogen
curved

14 cm – 5½"	OZ-5640-14	OZ- 5641-14
17 cm – 6¾"	OZ-5640-17	OZ-5641-17
20 cm – 8"	OZ- 5640-19	OZ- 5641-19
22 cm – 8¾"	OZ-5640-22	OZ-5641-22



LITTAUER-LISTON



15 cm – 6"

OZ-5642-15



BÖHLER



gerade
straight

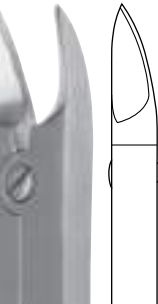
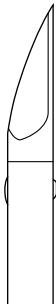

gebogen
curved

15 cm – 6"

OZ-5700-15	OZ-5701-15
-------------------	-------------------



Knochensplitterzangen Bone Cutting Forceps



MC INDOE

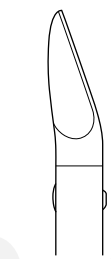

17,5 cm – 7"

OZ-5702-17



KAZANJIAN



18 cm – 7"

OZ-8125-18



RUSKIN-LISTON

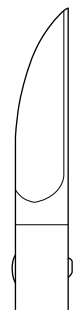

gerade
straight

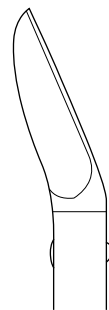

gebogen
curved

8,5 cm – 7¼"

OZ-5710-18

OZ-5711-18



OZZE MEDICAL & SURGICAL SUPPLIES
TOOLS TO OPERATE

Knochensplitterzangen Bone Cutting Forceps



STILLE-LISTON

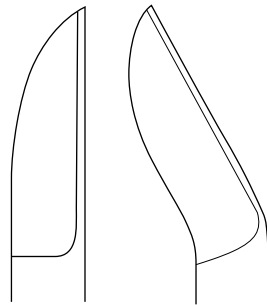

gerade
straight

gebogen
curved

23 cm – 9"	OZ-5716-23	OZ-5717-23
27 cm – 10½"	OZ- 5716-27	OZ-5717-27



S-gebogen
S-curved

LISTON-KEY-HORSLEY

1:3



27 cm – 10½"

OZ-5718-27



Instrumente für Fingernägel
Nail Instruments



Nagelspaltzange
Nail nipper

13,5 cm – 5¼"

OZ-5722-13



Rundzange
Round pliers

18 cm – 7"

OZ-5723-04



Flachzange
Flat nose pliers

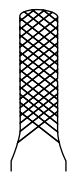

18 cm – 7"

OZ-5723-18

OZ-5724-18



Nagelausreißzange
Nail pulling forceps



13,5 cm – 5¼"

OZ-5726-13

RADOLF

Sägen und Sägeblätter Saws and Saw Blades



Sägeblatt, allein
Saw blade, only

OZ-5727-21

Fingerringsäge,
kompl. mit 1 Sägeblatt
*Finger ring saw,
compl. with 1 saw blade*

17 cm – 6¾"

OZ-5727-17



Sägeblatt, allein,
für Hartmetall nicht geeignet
*Saw blade, only,
not suitable for carbide metal*

OZ-5728-21

Fingerringsäge,
kompl. mit 1 Sägeblatt
*Finger ring saw,
compl. with 1 saw blade*

15 cm – 6"

OZ-5728-17



Sägeblatt, allein
Saw blade, only

OZ-5732-99



1:3
LANGENBECK

23 cm – 9"

OZ-5730-23



1:3
SATTERLEE

31 cm – 12¼"

OZ-5732-31



Sägen und Sägeblätter Saws and Saw Blades



Sägeblatt, allein
Saw blade, only

OZ-5735-99

27 cm – 10½"

OZ-5735-27

1:3

CHARRIÈRE



CHARRIÈRE

Säge komplett, bestehend aus:
Saw complete, consisting of:

OZ-5736-35

1 Säge 35 cm – 13¾"

1 *Saw 35 cm – 13¾"*

1 Sägeblatt 12 mm (OZ- 5736-42)

1 *Saw blade 12 mm (OZ-5736-42)*

1 Sägeblatt 15 mm (OZ-5736-45)

1 *Saw blade 15 mm (OZ-5736-45)*

Blattbreite <i>Blade width</i>	Sägeblätter <i>Saw blades</i>
12 mm	OZ-5736-42
15 mm	OZ-5736-45



Bohrapparate Hand Drills



Griff, allein
Handle, only

27 cm – 10½"

OZ-5744-10



Fig. 9

Verlängerungsstück
Extension piece

7,5 cm – 3"

OZ-5744-09

HUDSON

Bohrapparat komplett, bestehend aus:
Hand drill complete, consisting of:

OZ-5744-00

Griff, allein (OZ-5744-10)
Handle, only (OZ-5744-10)

Fräser Fig. 1 (OZ-5744-01)
Cutter Fig. 1 (OZ-5744-01)

Fräser Fig. 2 (OZ-5744-02)
Cutter Fig. 2 (OZ-5744-02)

Fräser Fig. 3 (OZ-5744-03)
Cutter Fig. 3 (OZ-5744-03)

Fräser Fig. 4 (OZ-5744-04)
Cutter Fig. 4 (OZ-5744-04)

Verlängerungsstück Fig. 9 (OZ-5744-09)
Extension piece Fig. 9 (OZ-5744-09)



HUDSON

CUSHING

MC KENZIL ERRICO

Fig. 1	Fig. 2	Fig. 3	Fig. 4	Fig. 5			
Ø 9 mm	Ø 14 mm	Ø 16 mm	Ø 22 mm	Ø 14 mm	Ø 2 mm	Ø 13 mm	Ø 16 mm
OZ-5744-01	OZ-5744-02	OZ-5744-03	OZ-5744-04	OZ-5744-05	OZ-5744-06	OZ-5744-07	OZ-5744-08

Bohrapparate Hand Drills



Hand drill complete, consisting of:

Bohrapparat komplett, bestehend aus:	OZ-5746-00
--------------------------------------	-------------------

Griff, allein 24 cm – 9½" (OZ-5746-10)
Handle, only 24 cm – 9½" (OZ-5746-10)

Bohrer Fig. 1 (OZ-5746-01)
Drill Fig. 1 (OZ-5746-01)

Bohrer Fig. 2 (OZ-5746-02)
Drill Fig. 2 (OZ-5746-02)

Bohrer Fig. 3 (OZ-5746-03)
Drill Fig. 3 (OZ-5746-03)

Bohrer Fig. 4 (OZ-5746-04)
Drill Fig. 4 (OZ-5746-04)

Bohrer Fig. 5 (OZ-5746-05)
Drill Fig. 5 (OZ-5746-05)

Fräser Fig. 6 (OZ-5746-06)
Cutter Fig. 6 (OZ-5746-06)

Fräser Fig. 7 (OZ-5746-07)
Cutter Fig. 7 (OZ-5746-07)









Fräser Fig. 8 (OZ-5746-08)
Cutter Fig. 8 (OZ-5746-08)

Fräser Fig. 9 (OZ-5746-09)
Cutter Fig. 9 (OZ-5746-09)

Griff, allein
Handle, only

24 cm – 9½"

OZ-5746-10

								
Fig. 1	Fig. 2	Fig. 3	Fig. 4	Fig. 5	Fig. 6	Fig. 7	Fig. 8	Fig. 9
Ø 2,5 mm	Ø 3 mm	Ø 3,5 mm	Ø 4 mm	Ø 10 mm	Ø 5 mm	Ø 8 mm	Ø 12 mm	Ø 16 mm
OZ-5746-01	OZ-5746-02	OZ-5746-03	OZ-5746-04	OZ-5746-05	OZ-5746-06	OZ-5746-07	OZ-5746-08	OZ-5746-09



OZZE MEDICAL & SURGICAL SUPPLIES
TOOLS TO OPERATE

Bohrapparate Hand Drills



1:3

Bohrapparat mit umstellbaren Handgriff:
Hand drill with adjustable handle:

OZ-5746-50

1 Dreibackenspannfutter
1 Three-jaw-chuck
1 Schlüssel
1 Wrench



Handgriff mit Jacobs-Spannfutter
0,5 - 7 mm und Spanschlüssel, allein
*Handle with Jacobs chuck 0.5 - 7 mm
and wrench, only*

OZ-5747-01

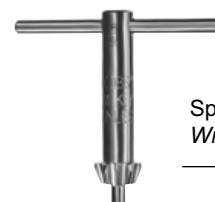

Spanschlüssel, allein
Wrench, only

OZ-5747-11

Reibahlen Reamers

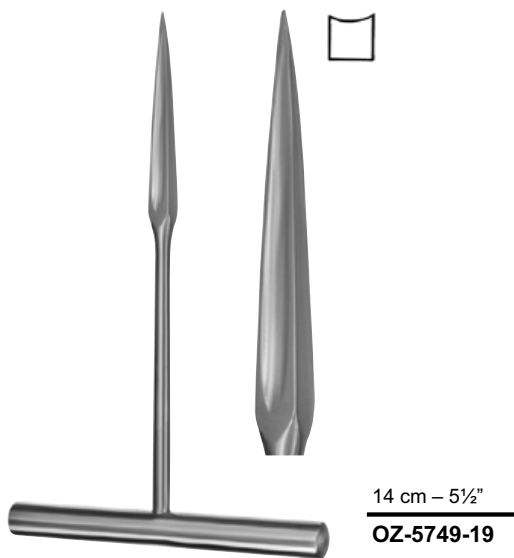
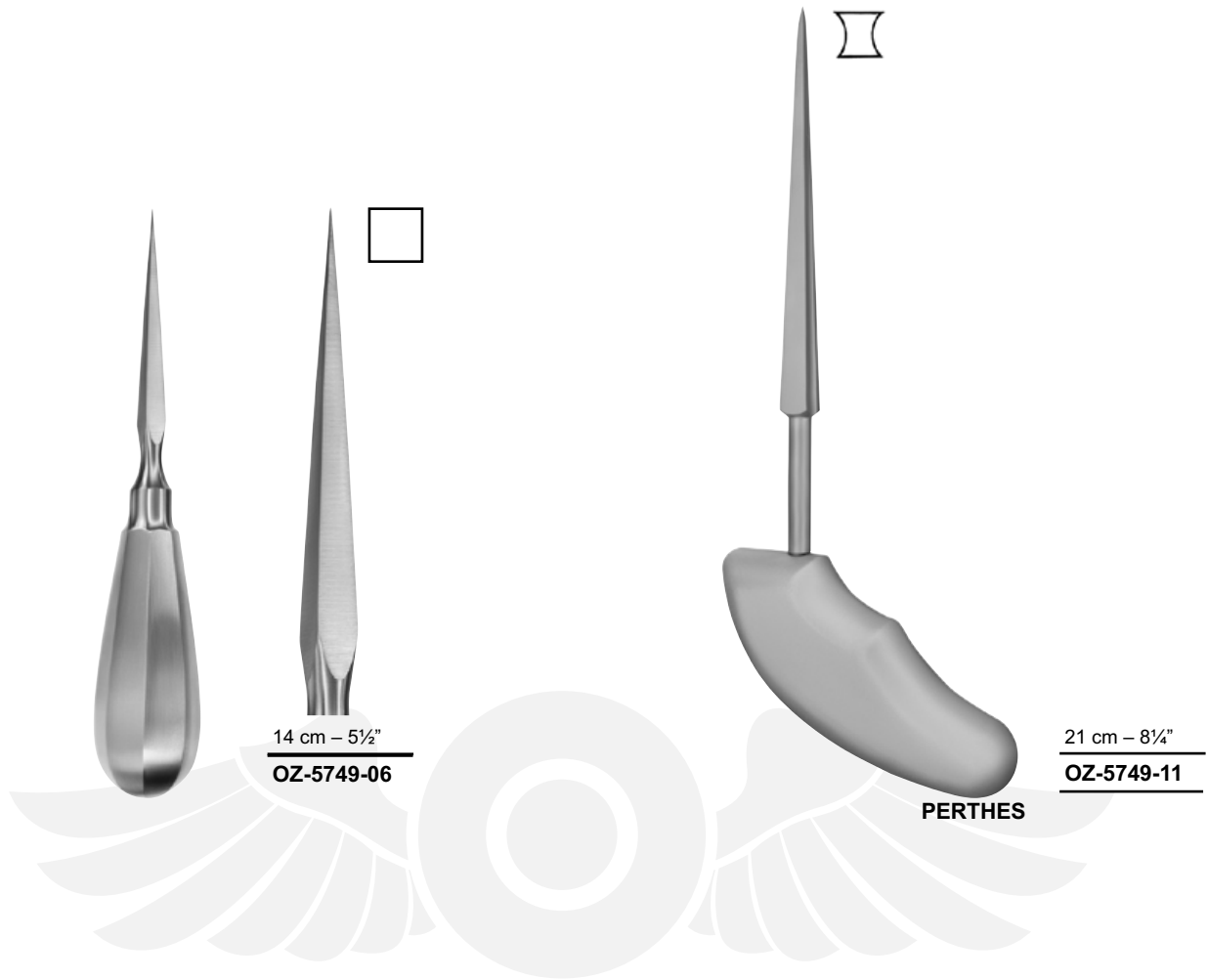



Trokarspitze, mit flachem Ende
(Verpackungseinheit à 10 Stück)

Trocar point, with flat shaft
(Packing unit 10 pieces)

1:1
KIRSCHNER

Ø mm	Länge Length			
	60 mm – 2½"	100 mm – 4"	155 mm – 6"	310 mm – 12¼"
0,8	OZ-5750-08	OZ-5751-08	OZ-5754-08	OZ-5755-08
1	OZ-5750-10	OZ-5751-10	OZ-5754-10	OZ-5755-10
1,1	OZ-5750-11	OZ-5751-11	OZ-5754-11	OZ-5755-11
1,2	OZ-5750-12	OZ-5751-12	OZ-5754-12	OZ-5755-12
1,4	OZ-5750-14	OZ-5751-14	OZ-5754-14	OZ-5755-14
1,5	OZ-5750-15	OZ-5751-15	OZ-5754-15	OZ-5755-15
1,6	OZ-5750-16	OZ-5751-16	OZ-5754-16	OZ-5755-16
1,7	OZ-5750-17	OZ-5751-17	OZ-5754-17	OZ-5755-17
1,8	OZ-5750-18	OZ-5751-18	OZ-5754-18	OZ-5755-18
1,9	OZ-5750-19	OZ-5751-19	OZ-5754-19	OZ-5755-19
2	OZ-5750-20	OZ-5751-20	OZ-5754-20	OZ-5755-20
2,2	OZ-5750-22	OZ-5751-22	OZ-5754-22	OZ-5755-22
2,5	OZ-5750-25	OZ-5751-25	OZ-5754-25	OZ-5755-25
2,8	OZ-5750-28	OZ-5751-28	OZ-5754-28	OZ-5755-28
3	OZ-5750-30	OZ-5751-30	OZ-5754-30	OZ-5755-30



Trokarspitze, mit rundem Ende
(Verpackungseinheit à 10 Stück)

Trocar point, with round shaft
(Packing unit 10 pieces)

1:1

Ø mm	Länge Length			
	60 mm – 2½"	100 mm – 4"	155 mm – 6"	310 mm – 12¼"
0,8	OZ-5750-38	OZ-5751-38	OZ-5754-38	OZ-5755-38
1	OZ-5750-40	OZ-5751-40	OZ-5754-40	OZ-5755-40
1,1	OZ-5750-41	OZ-5751-41	OZ-5754-41	OZ-5755-41
1,2	OZ-5750-42	OZ-5751-42	OZ-5754-42	OZ-5755-42
1,4	OZ-5750-44	OZ-5751-44	OZ-5754-44	OZ-5755-44
1,5	OZ-5750-45	OZ-5751-45	OZ-5754-45	OZ-5755-45
1,6	OZ-5750-46	OZ-5751-46	OZ-5754-46	OZ-5755-46
1,7	OZ-5750-47	OZ-5751-47	OZ-5754-47	OZ-5755-47
1,8	OZ-5750-48	OZ-5751-48	OZ-5754-48	OZ-5755-48
1,9	OZ-5750-49	OZ-5751-49	OZ-5754-49	OZ-5755-49
2	OZ-5750-50	OZ-5751-50	OZ-5754-50	OZ-5755-50
2,2	OZ-5750-52	OZ-5751-52	OZ-5754-52	OZ-5755-52
2,5	OZ-5750-55	OZ-5751-55	OZ-5754-55	OZ-5755-55
2,8	OZ-5750-58	OZ-5751-58	OZ-5754-58	OZ-5755-58
3	OZ-5750-60	OZ-5751-60	OZ-5754-60	OZ-5755-60

Bohrdrähte, Steinmann-Nägel Drill Wires, Steinmann Pins



Trokarspitze, mit Trokarende
(Verpackungseinheit à 10 Stück)

*Trocar point, with trocar shaft
(Packing unit 10 pieces)*

Ø mm	Länge Length		
	100 mm – 4"	155 mm – 6"	310 mm – 12¼"
0,8	OZ-5756-08	OZ-5756-38	OZ-5756-68
1	OZ-5756-10	OZ-5756-40	OZ-5756-70
1,1	OZ-5756-11	OZ-5756-41	OZ-5756-71
1,2	OZ-5756-12	OZ-5756-42	OZ-5756-72
1,4	OZ-5756-14	OZ-5756-44	OZ-5756-74
1,5	OZ-5756-15	OZ-5756-45	OZ-5756-75
1,6	OZ-5756-16	OZ-5756-46	OZ-5756-76
1,7	OZ-5756-17	OZ-5756-47	OZ-5756-77
1,8	OZ-5756-18	OZ-5756-48	OZ-5756-78
1,9	OZ-5756-19	OZ-5756-49	OZ-5756-79
2	OZ-5756-20	OZ-5756-50	OZ-5756-80
2,2	OZ-5756-22	OZ-5756-52	OZ-5756-82
2,5	OZ-5756-25	OZ-5756-55	OZ-5756-85
2,8	OZ-5756-28	OZ-5756-58	OZ-5756-88
3	OZ-5756-30	OZ-5756-60	OZ-5756-90

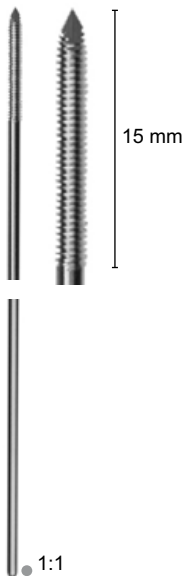
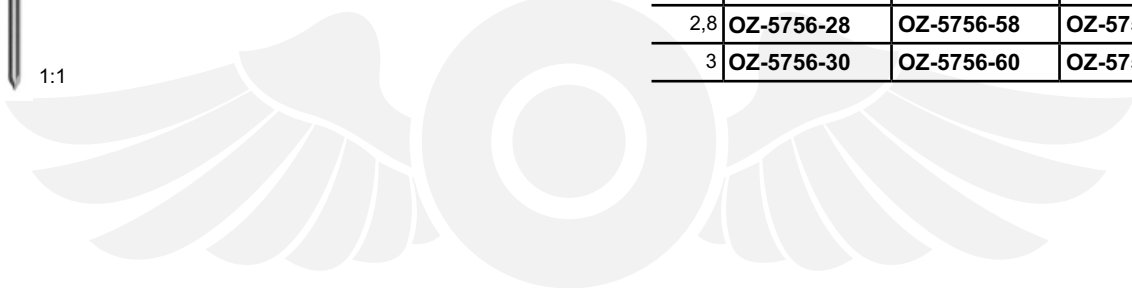

Trokarspitze, mit Gewinde
(Verpackungseinheit à 10 Stück)

*Trocar point, with thread
(Packing unit 10 pieces)*

Ø mm	Länge Length	
	155 mm – 6"	310 mm – 12¼"
1,2	OZ-5754-72	OZ-5755-72
1,4	OZ-5754-74	OZ-5755-74
1,6	OZ-5754-76	OZ-5755-76
1,8	OZ-5754-78	OZ-5755-78
2	OZ-5754-80	OZ-5755-80
2,2	OZ-5754-82	OZ-5755-82
2,5	OZ-5754-85	OZ-5755-85



Bohrdrähte, Steinmann-Nägel Drill Wires, Steinmann Pins



Lanzenspitze
(Verpackungseinheit à 10 Stück)
*Lance point
(Packing unit 10 pieces)*

	Länge Length
Ø mm	310 mm – 12¼"
0,8	OZ-5758-08
0,9	OZ-5758-09
1	OZ-5758-10
1,1	OZ-5758-11
1,2	OZ-5758-12
1,3	OZ-5758-13
1,4	OZ-5758-14
1,5	OZ-5758-15
1,6	OZ-5758-16
1,7	OZ-5758-17
1,8	OZ-5758-18
1,9	OZ-5758-19
2	OZ-5758-20
2,2	OZ-5758-22
2,4	OZ-5758-24
2,5	OZ-5758-25
2,6	OZ-5758-26
2,8	OZ-5758-28
3	OZ-5758-30



Trokarspitze, mit 3-kant Ende
Trocar point, with triangular end

Länge Length	Ø 4 mm	Ø 4,5 mm	Ø 5 mm
8 cm	OZ-5784-08	OZ-5785-08	OZ-5786-08
10 cm	OZ-5784-10	OZ-5785-10	OZ-5786-10
12 cm	OZ-5784-12	OZ-5785-12	OZ-5786-12
14 cm	OZ-5784-14	OZ-5785-14	OZ-5786-14
16 cm	OZ-5784-16	OZ-5785-16	OZ-5786-16
18 cm	OZ-5784-18	OZ-5785-18	OZ-5786-18
20 cm	OZ-5784-20	OZ-5785-20	OZ-5786-20
22 cm	OZ-5784-22	OZ-5785-22	OZ-5786-22
25 cm	OZ-5784-25	OZ-5785-25	OZ-5786-25
30 cm	OZ-5784-30	OZ-5785-30	OZ-5786-30

STEINMANN



OZZE MEDICAL & SURGICAL SUPPLIES
TOOLS TO OPERATE

Drahtspannzangen Wire Twisting Forceps



14 cm – 5½"
OZ-5760-14



16 cm – 6¼"
OZ-5760-16



Körnung 0,5 mm
Grit 2500 tpsi



Typ / Type	18 cm – 7"	
TC	OZ-5723-18	OZ-5724-18

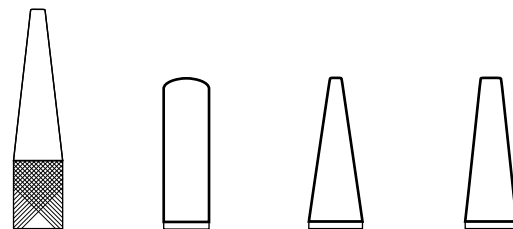

Typ / Type	18,5 cm – 7¼"	17,5 cm – 7"		
TC	OZ-5761-17	OZ-5761-18	OZ-5761-19	OZ-5761-20



OZZE MEDICAL & SURGICAL SUPPLIES
TOOLS TO OPERATE

Drahtspannzangen Wire Twisting Forceps

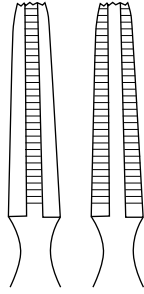

13 cm – 5"	OZ-5761-41
18 cm – 7"	OZ-5761-42



Körnung 0,5 mm
Grit 2500 tpsi



Typ / Type	18 cm – 7"
TC	OZ-5761-08



Typ / Type	20 cm – 8"
TC	OZ-5761-09



Körnung 0,5 mm
Grit 2500 tpsi

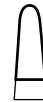
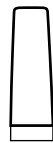

Typ / Type	15 cm – 6"	20 cm – 8"	15 cm – 6"
TC	OZ-5761-10	OZ-5761-11	OZ-5761-12



Drahtfasszangen Wire Holding Forceps



Körnung 0,5 mm
Grit 2500 tpsi

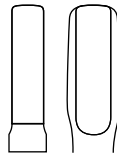

Typ / Type	17 cm – 6¾"
TC	OZ-5761-15



Drahtschneide- und Biegezange
Wire cutting and bending pliers

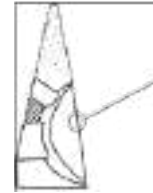

Schne / Cutting
weich / soft
1.5 mm

hart / hard	1.0 mm
-------------	--------

16 cm – 6¼"
OZ-5759-16

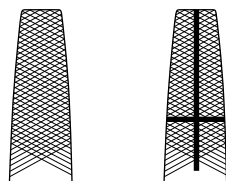

17 cm – 6¾"

OZ-5761-31	OZ-5761-32
-------------------	-------------------

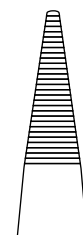

19 cm – 7½"

OZ-5761-33



OZZE MEDICAL & SURGICAL SUPPLIES
TOOLS TO OPERATE

Flachzangen Flat Nose Pliers



rostfreier Stahl
stainless steel

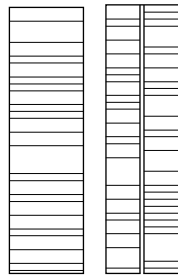

18,5 cm – 7¼"

OZ-5764-00



rostfreier Stahl
stainless steel



18 cm – 7"

OZ-5764-51



18 cm – 7"

OZ-5764-60

Drahtschneidezangen Wire Cutting Pliers

für weichen Knochen Draht bis Ø
für harte Bohrdrähte/Knochennägel bis Ø
for soft bone wire with a max. diameter of
for hard drill wires/bone nails with a max. diameter of



weich soft	Ø 2 mm
hart hard	Ø 1,5 mm

Typ / Type	15 cm – 6"
TC	OZ-5762-15



weich soft	Ø 1,7 mm
---------------	----------

Drahtschneider durchbohrt
Cannulated wire cutter

18,5 cm – 7¼"
OZ-5762-18



weich soft	Ø 2 mm
hart hard	Ø 2 mm

16 cm – 6¼"
OZ-5762-50



weich soft	Ø 3,5 mm
hart hard	Ø 3,5 mm

24 cm – 9½"
OZ-5765-24



Drahtschneidezangen Wire Cutting Pliers

für weichen Knochen Draht bis Ø
für harte Bohrdrähte/Knochen Nägel bis Ø
for soft bone wire with a max. diameter of
for hard drill wires/bone nails with a max. diameter of

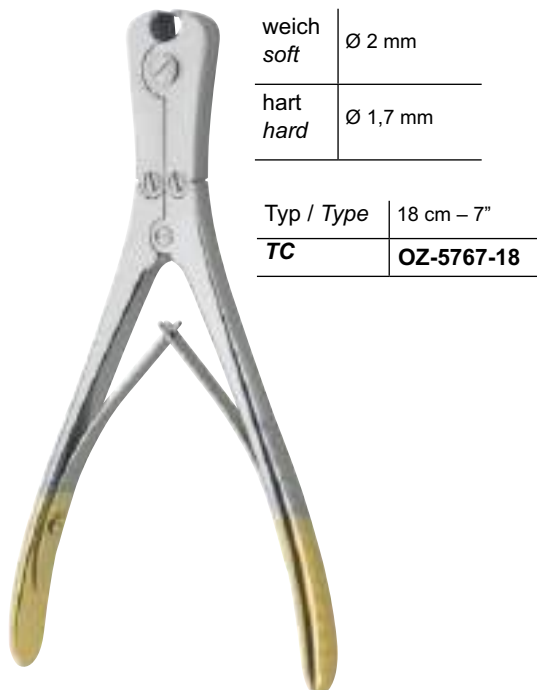
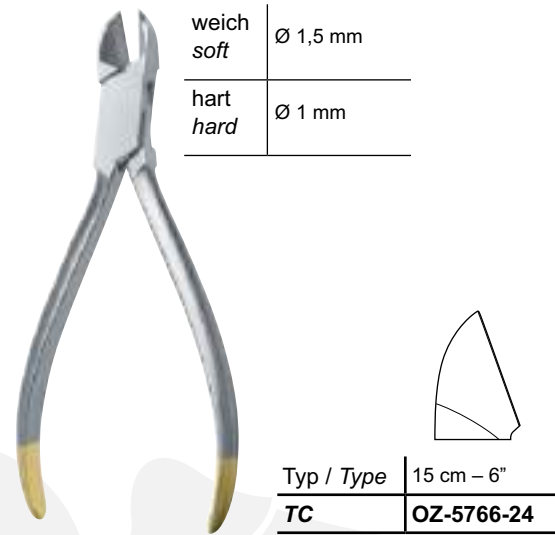
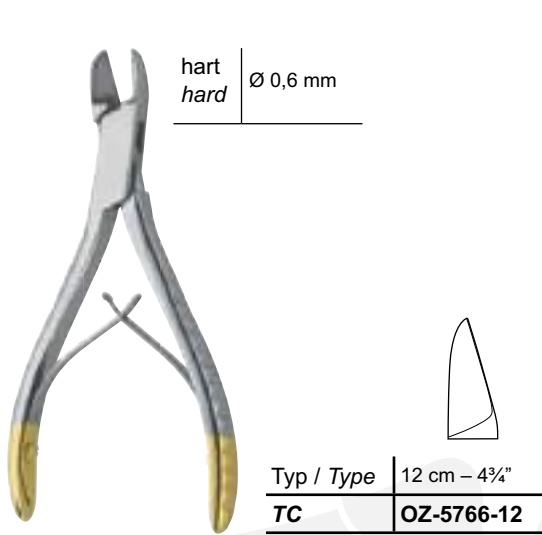

**MODELL RUDOLF
RUDOLF PATTERN**

Drahtschneidezangen Wire Cutting Pliers

für weichen Knochen draht bis Ø
für harte Bohrdrähte/Knochen nÄgel bis Ø
for soft bone wire with a max. diameter of
for hard drill wires/bone nails with a max. diameter of

Bolzenschneider zum Abzwicken
von DrÄhten, Schrauben und
NÄgeln bis zu Ø 6 mm
Cutter for cutting off wires,
bolts and pins up to Ø 6 mm



weich soft	Ø 2,5 mm
hart hard	Ø 1,5 mm

**MODELL RUDOLF
RUDOLF PATTERN**

Typ / Type	18,5 cm – 7¼"
TC	OZ-5768-18



1:3



1:3

47 cm – 18½"	OZ-5767-47
54 cm – 21¼"	OZ-5767-57

1:4

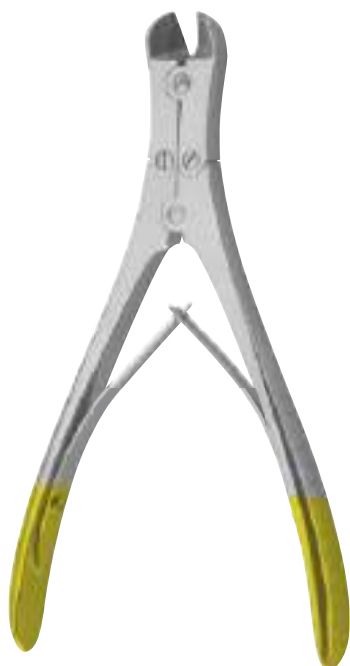

Typ / Type	18 cm – 7"
TC	OZ-5769-18
weichsoft	Ø 2 mm
harthard	Ø 1,7 mm

Typ / Type	22 cm – 8¾"
TC	OZ-5769-22
weichsoft	Ø 3 mm
harthard	Ø 2,5 mm



hart hard	Ø 2,2 mm
--------------	----------

1:3

Typ / Type	23,5 cm – 9¼"
TC	OZ-5769-32

Extensionsbügel Extension Bows

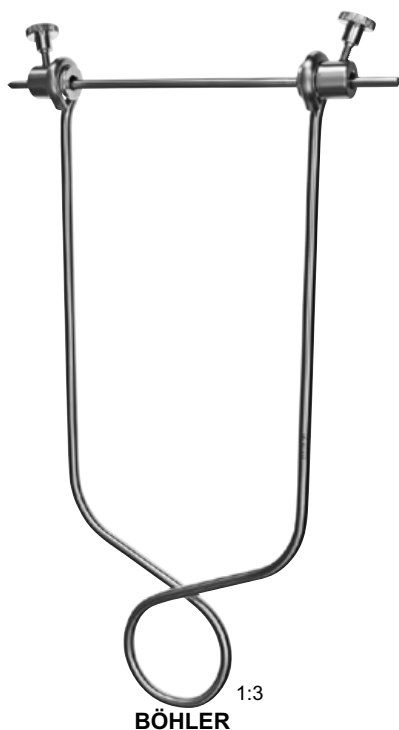

mit 1 Nagel
with 1 pin

für Arm
for arm

16 x 9 cm – 6¼" x 3½"	OZ-5770-16
-----------------------	-------------------

für Oberschenkel und Knie
for thigh and knee

21 x 11 cm – 8¼" x 4¼"	OZ-5770-21
------------------------	-------------------



lichte Weite
clear width

18 x 10 cm – 7" x 4"	OZ-5773-18
27 x 16 cm – 10½" x 6¼"	OZ-5773-27

Cerclage-Instrumente Cerclage Instruments

Knochendraht in
Ringen zu 10 m
*Bone wire
coil of 10 m*



Ø mm	weichsoft
0,2	OZ-5778-02
0,3	OZ-5778-03
0,4	OZ-5778-04
0,5	OZ-5778-05
0,6	OZ-5778-06
0,7	OZ-5778-07
0,8	OZ-5778-08
0,9	OZ-5778-09
1,0	OZ-5778-10
1,2	OZ-5778-12
1,5	OZ-5778-15

Drahtspanninstrument
Bone wire tighteners



21 cm – 8¼"

OZ-5782-00

LOUTE

Drahtumführungsnadeln
Bone wire guides



1:3
DEMEL

30,5 cm – 12"	Fig. 1	OZ-5780-01
28,5 cm – 11¼"	Fig. 2	OZ-5780-02
27,5 cm – 10¾"		OZ-5780-03

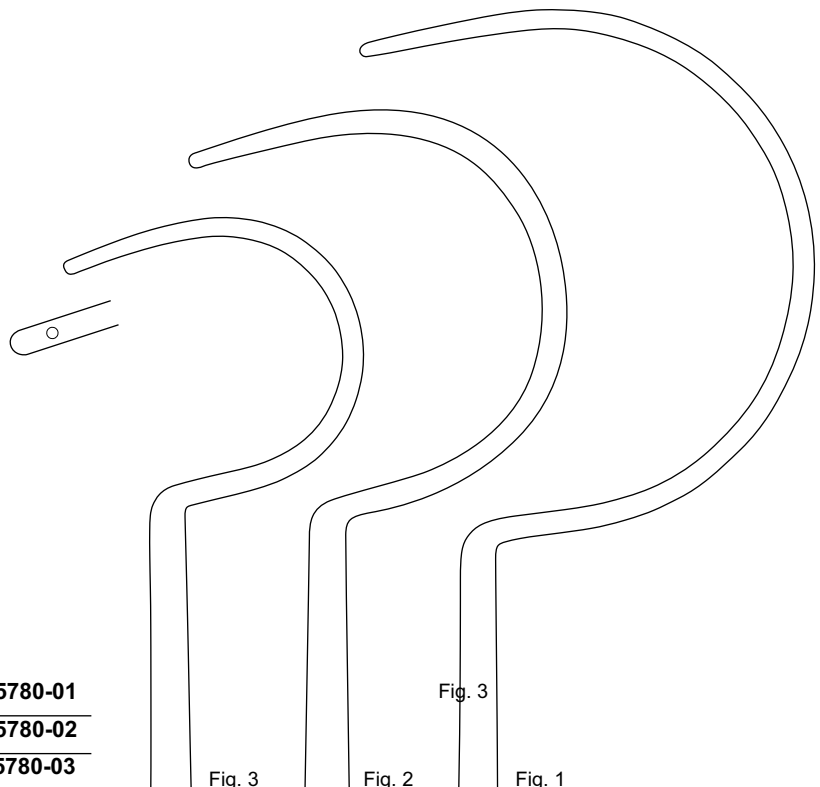

Fig. 3

Fig. 2

Fig. 1



Hämmer Mallets



Ø 25 mm
160 g

mit auswech selbarer
Kunststoffbacke
*with interchangeable
plastic disk*

1 Ersatzbacke
1 Spare disk

OZ-5797-51

18,5 cm – 7¼"
OZ-5797-17



Ø 30 mm
230 g

mit auswech selbaren
Kunststoffbacken
*with interchangeable
plastic disks*

Ersatzbackenpaar
Pair of spare disks

OZ-5798-51

24 cm – 9½"
OZ-5798-24

1:3



Ø 25 mm
135 g

mit auswech selbaren
Kunststoffbacken
*with interchangeable
plastic disks*

Ersatzbackenpaar
Pair of spare disks

OZ-5799-51

19 cm – 7½"
OZ-5799-18



Ø 30 mm
300 g

23,5 cm – 9¼"
OZ-5800-23

1:3
BERGMANN



Hämmer Mallets



Ø 14 / 24 mm
420 g

Kopf massiv, aus
Implant-Werkstoff

*Head massive, made
of implantat material*

23,5 cm – 9¼"

OZ-5801-23

1:3



Ø 45 mm
380 g

24 cm – 9½"

OZ-5802-24

1:3

BERGMANN



Ø 30 mm
180 g

24 cm – 9½"

OZ-5803-10

Ø 40 mm
350 g

24 cm – 9½"

OZ-5803-35

Ø 45 mm
500 g

24 cm – 9½"

OZ-5803-50

Ø 50 mm
700 g

24 cm – 9½"

OZ-5803-70



Ø 30 / 42 mm
400 g

24 cm – 9½"

OZ-5804-24



OZZE MEDICAL & SURGICAL SUPPLIES
TOOLS TO OPERATE

Hämmer Mallets



Ø 40 mm
700 g

18 cm – 7"

OZ-5805-18



Ø 40 mm
550 g

24 cm – 9½"

OZ-5806-24

1:3
OMBREDANNE

HEATH



Ø 30 mm
480 g

23,5 cm – 9¼"

OZ- 5807-00/00 komplett mit:
OZ- 5807-00/01
OZ- 5807-00/02
OZ- 5807-00/03

OZ- 5807-00/00 complete with
OZ- 5807-00/01
OZ- 5807-00/02
OZ-5807-00/03

Ø 30 mm
220 g

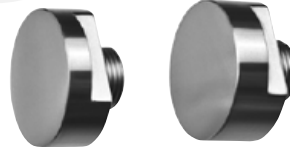

Metallbackenpaar
Pair of metal faces

OZ-5807-00/01

Backen 1x konvex / 1x flach
faces 1x convex / 1x flat

Ø 30 mm
40 g

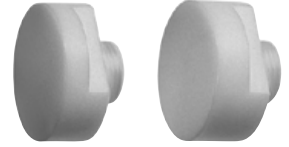

Kunststoffbackenpaar
Pair of synthetic faces

OZ-5807-00/02

Backen 1x konvex / 1x flach
faces 1x convex / 1x flat



Schlüssel
Wrench

OZ-5807-00/03



Hämmer Mallets



Ø 35 mm
100 g
26 cm – 10¼"
OZ-5808-01

Ø 43 mm
170 g
26 cm – 10¼"
OZ-5808-02

Ø 50 mm
220 g
26 cm – 10¼"
OZ-5808-03

1:3



Ø 30 mm
380 g

mit Kunststoffstiel
with plastic handle

24 cm – 9½"
OZ-5808-24

1:3



170 g

170 g
bleigefüllt
lead filled
23 cm – 9"
OZ-5810-23

WILLIGER



Ø 22 mm
170 g

Ø 22 mm
170 g
bleigefüllt
lead filled
19 cm – 7¾"
OZ-5812-19



Ø 22 mm
135 g

Ersatzbackenpaar
Pair of spare disks
OZ-5819-20
19,5 cm – 9½"
OZ-5819-19



Hämmer Mallets



Ø 25 mm
220 g

19 cm – 7½"

OZ-5820-19

GERZOG



Ø 30 mm
240 g

konvex / flach
convex / flat

19 cm – 7½"

OZ-5809-19

COTTLE



Ø 27 mm
145 g

20 cm – 8"

OZ-5811-23

HAJEK

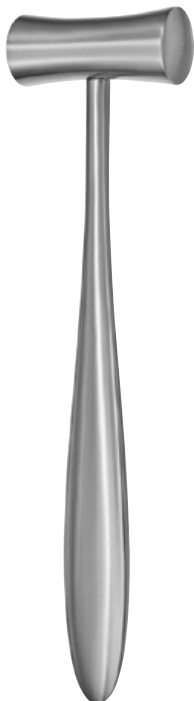

Ø 19 mm
80 g

19 cm – 7½"

OZ-5813-01

LUCAE

Ø 25 mm
250 g

19 cm – 7½"

OZ-5813-02



Ø 20 mm
100 g

bleigefüllt
lead filled

16,5 cm – 6½"

OZ-5814-16

Ø 20 mm
75 g

Messing
Brass

16,5 cm – 6½"

OZ-5815-16



Hämmer Mallets



MEAD

Ø 26 mm
170 g

mit auswech selbaren
Kunststoffbacken
*with interchangeable
plastic disks*

Ersatzbackenpaar
Pair of spare disks

OZ-5816-20

19 cm – 7½"

OZ-5816-17



PARTSCH

Ø 22 mm
115 g

bleigefüllt
lead filled

18 cm – 7"

OZ-5819-18





OZZE MEDICAL & SURGICAL SUPPLIES
TOOLS TO OPERATE

Sehneninstrumente Tendon Instruments



Sehnedurchziehzange
Tendon passing forceps

KLEINERT-KUTZ



leicht gebogen
slightly curved

20 cm – 8"

OZ-5827-35



Sehnenfasszange
Tendon seizing forceps

BRAND



gerade
straight

gebogen
curved

15 cm – 6"	OZ-3160-15	OZ-3161-15
19 cm – 7½"	OZ-3160-19	OZ-3161-19
24 cm – 9½"	OZ-3160-24	OZ-3161-24

Sehneninstrumente Tendon Instruments

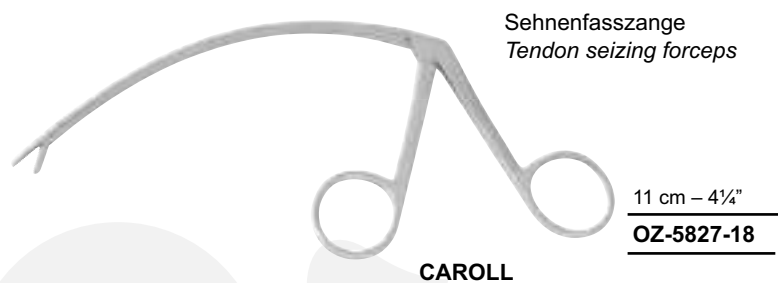

15 cm – 6"
OZ-5827-20 | **OZ-5827-21**



OZZE MEDICAL & SURGICAL SUPPLIES
TOOLS TO OPERATE

Sehneninstrumente Tendon Instruments



Sehnscheidenhaken
Tendon sheath hooks



6 x 16 mm

6 x 16 mm

gezahnt
toothed

19 cm – 7½"

OZ-4482-01

OZ-4482-02

STRANDELL-STILLE



Sehnscheidenhaken
Tendon sheath hooks

12 x 6 mm



stumpf
blunt

17,5 cm – 7"

OZ-4483-01

KLAPP



1:4

Bleihand für
Kinder
*Lead hand for
children*

OZ-5822-01

Bleihand für
Erwachsene
*Lead hand
for adults*

OZ-5822-02



OZZE MEDICAL & SURGICAL SUPPLIES
TOOLS TO OPERATE





©ZZE MEDICAL & SURGICAL SUPPLIES

TOOLS TO OPERATE

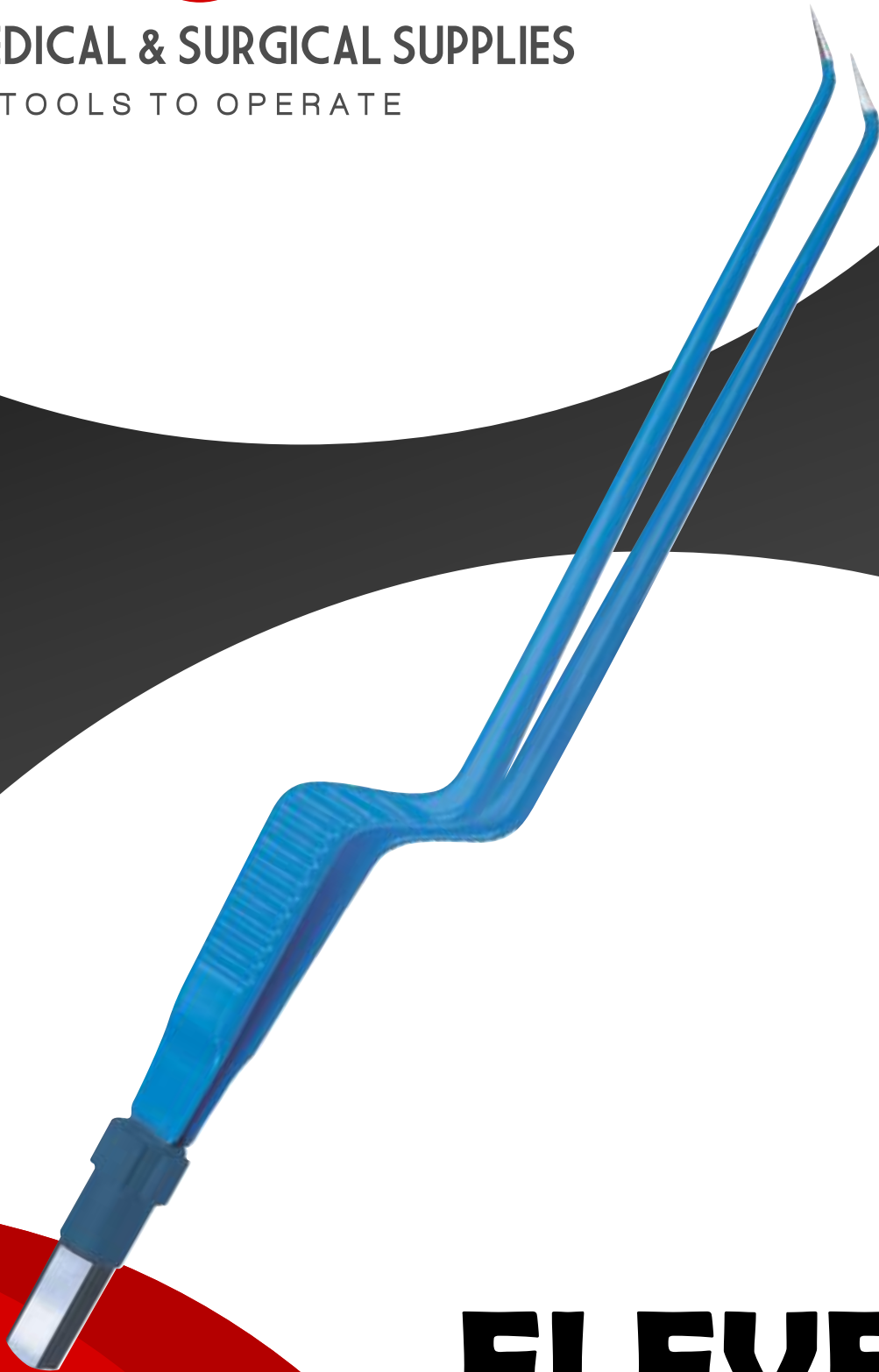

ELEVEN

 www.ozzesurgical.com.au

 info@ozzesurgical.com.au

HF-Handgriffe	<i>HF-Handles</i>	HF 1 - 2
Monopolare Elektroden	<i>Monopolar Electrodes</i>	HF 3 - 4
Bipolare Scheren	<i>Bipolar Scissors</i>	HF 5 - 6
Bipolare Pinzetten	<i>Bipolar Forceps</i>	HF 7 - 17
Bipolare Anschlusskabel	<i>Bipolar Connecting Cables</i>	HF 18



zur Verwendung mit Elektroden Ø 2,4 mm und 6-kant Schaft to
be used with electrodes Ø 2.4 mm and 6-edge shaft

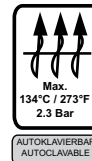

Ø 2,4 mm
max. voltage: 4.3 kVp
max. Spannung: 4,3 kVp
max. voltage: 4.3 kVp

Anschluss Geräteseite
Connection equipment side



HF-Handgriff evoline
für Erbe ACC / ICC, Storz-Geräte
HF-Handle evoline
for Erbe ACC / ICC, Storz devices

mit integriertem Kabelwith integrated cable mit 2 Tastenwith 2 buttons	Länge / Length 4 m	OZ-410-026
---	-----------------------	-------------------

Ø 2,4 mm
max. Spannung: 4,3 kVp
max. voltage: 4.3 kVp
max. voltage: 4.3 kVp

Anschluss Geräteseite
Connection equipment side



HF-Handgriff evoline
für Berchtold / Martin / Aesculap / INTEGRA-Geräte
HF-Handle evoline
for Berchtold / Martin / Aesculap / INTEGRA devices

mit integriertem Kabelwith integrated cable mit 2 Tastenwith 2 buttons	Länge / Length 4 m	OZ-410-028
---	-----------------------	-------------------

Ø 2,4 mm
max. Spannung: 4,3 kVp
max. voltage: 4.3 kVp

Anschluss Geräteseite
Connection equipment side



HF-Handgriff evoline
für Modelle mit internationalem Anschluss 3-polig
HF-Handle evoline
for models with international connection plug 3 pin

mit integriertem Kabelwith integrated cable mit 2 Tastenwith 2 buttons	Länge / Length 4 m	OZ-410-030
---	-----------------------	-------------------

HF-Handgriffe HF-Handles

zur Verwendung mit Elektroden Ø 4 mm und 6-kant Schaft
to be used with electrodes Ø 4 mm and 6-edge shaft

max. voltage: 4.3 kVp
max. Spannung: 4,3 kVp
max. voltage: 4.3 kVp

Anschluss Geräteseite
Connection equipment side

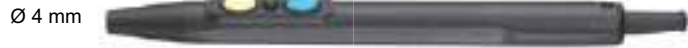

HF-Handgriff evoline

für Erbe ACC / ICC, Storz-Geräte

HF-Handle evoline

for Erbe ACC / ICC, Storz devices

mit integriertem Kabel with integrated cable mit 2 Tasten with 2 buttons	Länge / Length 4 m	OZ-410-020
---	-----------------------	-------------------

max. Spannung: 4,3 kVp
~~max. voltage: 4.3 kVp~~

Anschluss Geräteseite
Connection equipment side



HF-Handgriff evoline

für Berchtold / Martin / Aesculap / INTEGRA-Geräte

HF-Handle evoline

for Berchtold / Martin / Aesculap / INTEGRA devices

mit integriertem Kabel with integrated cable mit 2 Tasten with 2 buttons	Länge / Length 3 m	OZ-410-022
---	-----------------------	-------------------

max. Spannung: 4,3 kVp
max. voltage: 4.3 kVp

Anschluss Geräteseite
Connection equipment side



HF-Handgriff evoline

für Modelle mit internationalem Anschluss 3-polig

HF-Handle evoline

for models with international connection plug 3 pin



mit integriertem Kabel with integrated cable mit 2 Tasten with 2 buttons	Länge / Length 3 m	OZ-410-024
---	-----------------------	-------------------

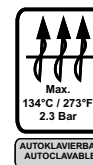

Monopolare Elektroden

Monopolar Electrodes







6-kant Schaft
6-edge shaft



Modell Model	Beschreibung Description	Abmessungen Dimensions	2,4 mm Schaft 2.4 mm shaft
	Lanzetten-Elektrode <i>Lancet electrode</i>	20 mm x 2,5 mm	OZ-0470-51
	Messer-Elektrode <i>Knife electrode</i>	20 mm x 2,5 mm	OZ-0470-54
	Nadel-Elektrode <i>Needle electrode</i>	18 mm x Ø 0,7 mm	OZ-0470-60

Modell Model	Beschreibung Description	Abmessungen Dimensions	2,4 mm Schaft 2.4 mm shaft
		Ø 2 mm	OZ- 0470-65
		Ø 4 mm	OZ-0470-67
		Ø 6 mm	OZ-0470-69

Monopolare Elektroden Monopolar Electrodes

6-kant Schaft
6-edge shaft

Modell Model	Beschreibung Description	Abmessungen Dimensions	4 mm Schaft 4 mm shaft
	Lanzetten-Elektrode <i>Lancet electrode</i>	19 mm x 1,6 mm	OZ-0470-01
	Lanzetten-Elektrode <i>Lancet electrode</i>	19 mm x 1,6 mm	OZ-0470-02
	Messer-Elektrode <i>Knife electrode</i>	25 mm x 3,3 mm	OZ-0470-04
	Nadel-Elektrode <i>Needle electrode</i>	22 mm x Ø 0,8mm	OZ-0470-10

Modell Model	Beschreibung Description	Abmessungen Dimensions	4 mm Schaft 4 mm shaft
	Kugel-Elektrode <i>Ball electrode</i>	Ø 2 mm	OZ-0470-15
		Ø 4 mm	OZ-0470-17
		Ø 6 mm	OZ-0470-19



Bipolare Scheren Bipolar Scissors



Allgemein

Merkmale unserer bipolaren Scheren:

Die Stromzufuhr erfolgt über eine Steckverbindung an nur einem Griff der Schere, die Handhabung während des OP's wird dadurch extrem erleichtert.

RUDOLF Bipolare Scheren ermöglichen das Schneiden und Präparieren bei gleichzeitiger Koagulation.

Unterschiedliche Arbeitslängen und zwei Versionen (Standard und schlank) erlauben den Einsatz für eine Vielzahl von Anwendungen.

Die spezielle Konstruktion macht sie besonders reparaturfreundlich.

Die Scherenschrauben dienen der Stromführung von einem auf das andere Scherenblatt, die Scherenblätter mit Voll-Keramik-Einlage können voneinander getrennt und nachgeschärft werden.

General information

Features of our bipolar scissors:

The power is supplied by means of a plug-in construction to one ring only. This simplifies handling during the operation considerably.

RUDOLF bipolar scissors enable cutting and dissection with simultaneous bipolar coagulation.

Various working length and two versions (standard and slim) allow the scissors to be used for a large number of applications.

The special construction ensures that the scissors are easy to repair.

The screws conduct the current from one blade to the other, the blades with a solid ceramic insert can be separated for re-sharpening.

Bipolare Scheren Bipolar Scissors







METZENBAUM



Länge <i>Length</i>	gebogen Standard- <i>curved Standard</i>	gebogen schlank- <i>curved slim</i>
18 cm – 7"	OZ-1381-18	OZ-1382-18
21 cm – 8¼"	OZ-1381-21	OZ-1382-21
23 cm – 9"	OZ-1381-23	OZ-1382-23
28 cm – 11"	OZ-1381-28	OZ-1382-28

Bipolare Anschlusskabel für abgebildete Scheren
Bipolar connecting cables for illustrated scissors

Gerätestecker <i>Plug, generator side</i>	Instrumentenstecker <i>Plug, instrument side</i>	Länge <i>Length</i>	
 Erbe ACC / ICC, Storz		3 m	OZ-300-202
		5 m	OZ-300-203
 Martin, Berchtold, Aesculap		3 m	OZ-300-204
		5 m	OZ-300-205
 Valleylab, Lamidey, EMC		3 m	OZ-300-206
		5 m	OZ-300-207



Bipolare Pinzetten Bipolar Forceps



Allgemein

Merkmale unserer bipolaren Pinzetten:

- Lieferbar mit Flachstecker, auf Anfrage auch mit 2-Pin-Stecker (US-Standard).
- Präzise schließende Arbeitsenden gewährleisten ein sicheres und schonendes Arbeiten. Die schlanke und feine Formgebung garantieren ein sicheres Arbeiten auch in besonders delikaten Einsatzbereichen bzw. an schwer zugänglichen Stellen.
- Die breite, geriefte Grifffläche ermöglicht eine sichere Handhabung.
- Die bewährte und äußerst beständige Isolationsbeschichtung gewährleistet die Sicherheit des Instrumentes.
- Unser Kunststoff-Sicherheitsstecker garantiert eine glatte Steckverbindung und damit sicheren elektrischen Kontakt.

NON-STICK Pinzetten:

NON-STICK Pinzetten verhindern das Verkleben des koagulierten Gewebes mit der Pinzettenspitze. Dafür sorgen spezielle polierte Edelmetallspitzen mit einer exzellenten Wärmeleitfähigkeit. Diese Antihafteigenschaften bleiben auch nach einem evtl. Nachpolieren erhalten, da die gesamten Pinzettenspitzen aus Edelmetall hergestellt sind und es sich nicht nur um eine Beschichtung handelt.

General information

Features of our bipolar forceps:

- Available with flat plug, on demand also with 2-pin-plug (US-Standard).
- The precise closing of the jaws ensures safe and gentle working.
- The slim and delicate design grants safe working in extremely delicate areas or in hard-to-reach places.
- The broad, rifeled surface of the handle ensures safe handling.
- The well proven and extremely durable isolation coating grants the safeness of the instrument.
- Our plastic-safety plug grants a smooth plugging and therefore a safe electric contact.

NON-STICK Forceps:

The NON-STICK forceps prevents the sticking of coagulated tissue on the forceps tips. This is possible due to specially polished tips made of precious metal having an excellent heat conductance. These anti-adhesion properties are not lost even after a possible re-polishing, due to the fact that the complete tip of the forceps is made of precious metal and it is not only a coating.



Bipolare Pinzetten

Bipolar Forceps



gerade
straight



gewinkelt
angled

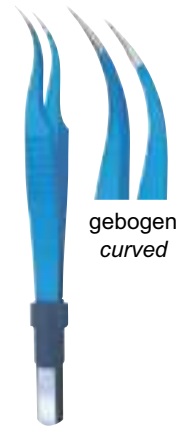

gebogen
curved

Anschluss Plug	Länge Length	Spitzenbreite Width of tips	Standard	NON-STICK	Standard	NON-STICK	Standard
	11 cm – 4¼"	0,25 mm	OZ-510-011	OZ-510-051	OZ-510-211	OZ-510-251	OZ-510-411
		0,60 mm	OZ-510-111	OZ-510-151	OZ-510-311	OZ-510-351	OZ-510-511
		1,00 mm	–	OZ-510-152	–	OZ-510-352	–

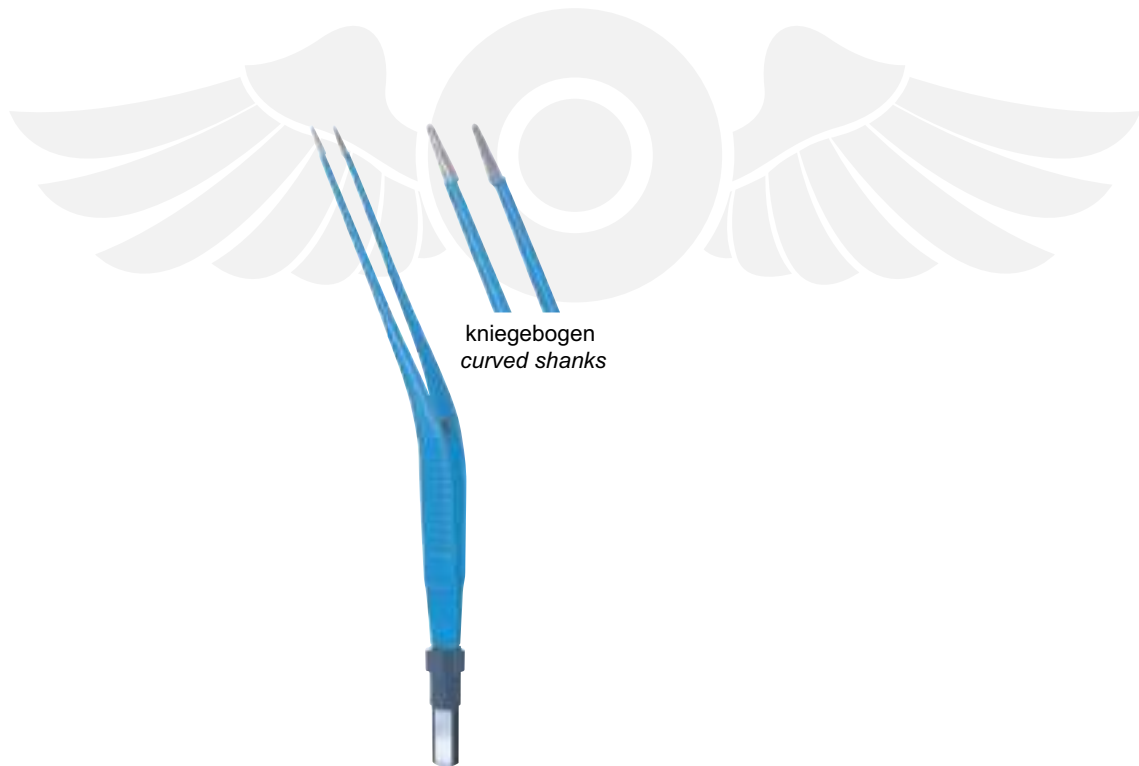

kniegebogen
curved shanks

Anschluss Plug	Länge Length	Spitzenbreite Width of tips	Standard
	17 cm – 6¾"	0,30 mm	HF518-017
		1,00 mm	HF518-117

Passende Bipolare Anschlusskabel auf Seite HF 18.

Suitable bipolar connecting cables on page HF 18.

Bipolare Pinzetten Bipolar Forceps



gerade
straight



gewinkelt
angled

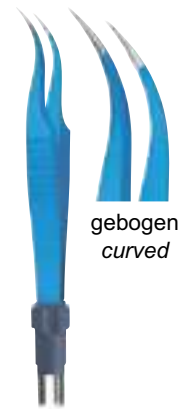

gebogen
curved

Anschluss Plug	Länge Length	Spitzenbreite Width of tips	Standard	NON-STICK	Standard	NON-STICK	Standard
	12 cm – 4¾"	0,25 mm	OZ-511-011	OZ0511-051	OZ-511-211	OZ-511-251	OZ-511-411
		0,80 mm	OZ-511-111	OZ-511-151	OZ-511-311	OZ-511-351	OZ-511-511
		1,00 mm	–	OZ-511-152	–	OZ-511-352	–



kniegebogen
curved shanks

Anschluss Plug	Länge Length	Spitzenbreite Width of tips	Standard
	17 cm – 6¾"	0,30 mm	OZ-519-017
		1,00 mm	OZ-519-117

2-Pin-Stecker (US-Standard).
Passende Bipolare Anschlusskabel auf Seite HF 18.

2-pin-plug (US-Standard).
Suitable bipolar connecting cables on page HF 18.

Bipolare Pinzetten

Bipolar Forceps



gerade
straight



gewinkelt
angled

Anschluss Plug	Länge Length	Spitzenbreite Width of tips	Standard	NON-STICK	Standard	NON-STICK
	15 cm – 6"	0,30 mm	OZ-515-015	OZ-515-055	OZ-515-515	OZ-515-555
		0,60 mm	–	OZ-515-056	–	–
		1,00 mm	OZ-515-115	OZ-515-155	OZ-515-615	OZ-515-655
		2,00 mm	–	OZ-515-156	–	OZ-515-656
	18 cm – 7"	0,30 mm	OZ-515-018	OZ-515-058	OZ-515-518	OZ-515-558
		0,60 mm	–	OZ-515-059	–	–
		1,00 mm	OZ-515-118	OZ-515-158	OZ-515-618	OZ-515-658
		2,00 mm	–	OZ-515-159	–	OZ-515-659
	20 cm – 8"	0,30 mm	OZ-515-020	OZ-515-070	OZ-515-520	–
		1,00 mm	OZ-515-120	OZ-515-170	OZ-515-620	–
		2,00 mm	–	OZ-515-171	–	–
	22 cm – 8¾"	0,30 mm	OZ-515-022	OZ-515-072	OZ-515-522	–
1,00 mm		OZ-515-122	OZ-515-172	OZ-515-622	–	
2,00 mm		–	OZ-515-173	–	–	
24 cm – 9½"	0,30 mm	OZ-515-024	–	OZ-515-524	–	
	1,00 mm	OZ-515-124	–	OZ-515-624	–	

Passende Bipolare Anschlusskabel auf Seite HF 18.

Suitable bipolar connecting cables on page HF 18.

Bipolare Pinzetten Bipolar Forceps

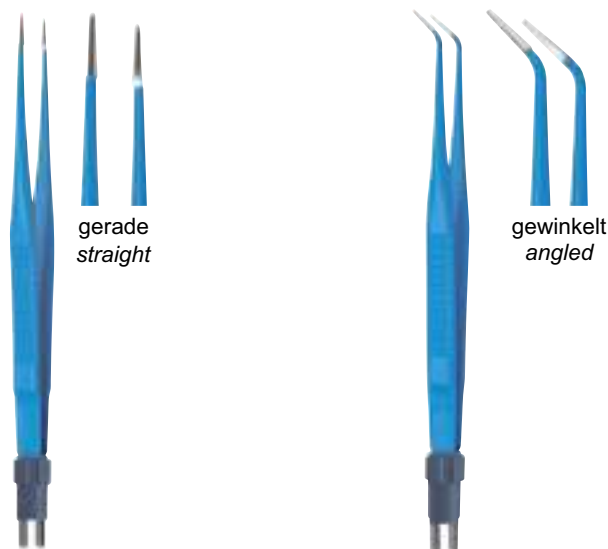

Anschluss Plug	Länge Length	Spitzenbreite Width of tips	Standard	NON-STICK	Standard	NON-STICK
	15 cm – 6"	0,30 mm	OZ-516-015	OZ-516-055	OZ-516-515	OZ-516-555
		0,60 mm	–	OZ-516-056	–	–
		1,00 mm	OZ-516-115	OZ-516-155	OZ-516-615	OZ-516-655
		2,00 mm	–	OZ-516-156	–	OZ-516-656
	18 cm – 7"	0,30 mm	OZ-516-018	OZ-516-058	OZ-516-518	OZ-516-558
		0,60 mm	–	OZ-516-059	–	–
		1,00 mm	OZ-516-118	OZ-516-158	OZ-516-618	OZ-516-658
		2,00 mm	–	OZ-516-159	–	OZ-516-659
	20 cm – 8"	0,30 mm	OZ-516-020	OZ-516-070	OZ-516-520	–
		1,00 mm	OZ-516-120	OZ-516-170	OZ-516-620	–
		2,00 mm	–	OZ-516-171	–	–
	22 cm – 8¾"	0,30 mm	OZ-516-022	OZ-516-072	OZ-516-522	–
1,00 mm		OZ-516-122	OZ-516-172	OZ-516-622	–	
2,00 mm		–	OZ-516-173	–	–	
24 cm – 9½"	0,30 mm	OZ-516-024	–	OZ-516-524	–	
	1,00 mm	OZ-516-124	–	OZ-516-624	–	

2-Pin-Stecker (US-Standard).
Passende Bipolare Anschlusskabel auf Seite HF 18.

2-pin-plug (US-Standard).
Suitable bipolar connecting cables on page HF 18.

Bipolare Pinzetten

Bipolar Forceps

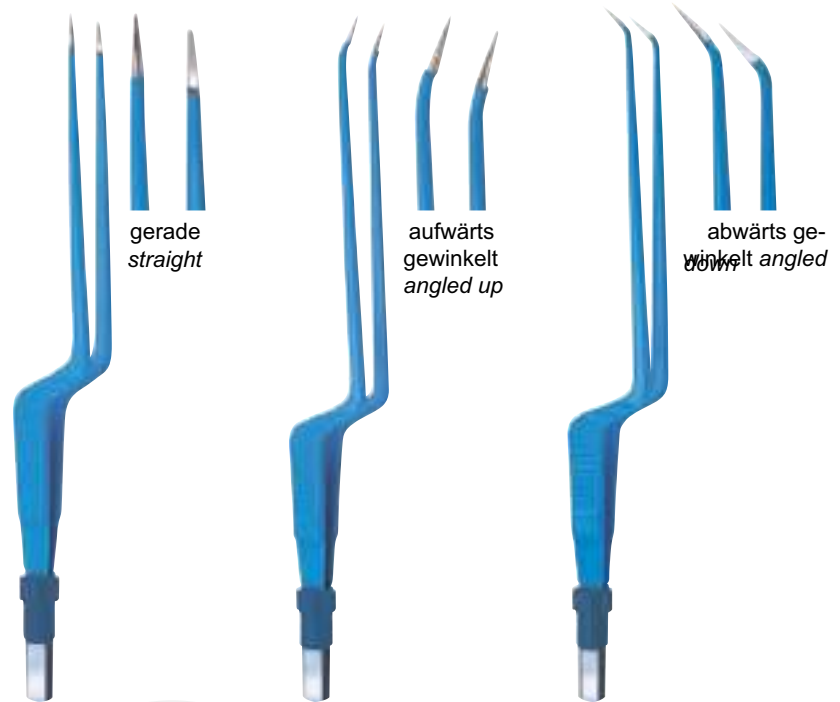



Anschluss Plug	Länge Length	Spitzenbreite Width of tips	Standard	NON-STICK	Standard	NON-STICK	Standard	NON-STICK
	16,5 cm – 6½"	0,60 mm	OZ-520-017	–	–	–	–	–
	18 cm – 7"	0,30 mm	OZ-520-018	OZ-520-058	OZ-520-418	–	OZ-520-818	–
		0,60 mm	–	OZ-520-059	–	–	–	–
		1,00 mm	OZ-520-118	OZ-520-158	OZ-520-518	–	OZ-520-918	–
		2,00 mm	–	OZ-520-159	–	–	–	–
	20 cm – 8"	0,30 mm	OZ-520-020	OZ-520-070	OZ-520-420	–	OZ-520-820	–
		0,60 mm	–	OZ-520-071	–	–	–	–
		1,00 mm	OZ-520-120	OZ-520-170	OZ-520-520	OZ-520-570	OZ-520-920	OZ-520-970
		2,00 mm	–	OZ-520-171	–	–	–	–
	22 cm – 8¾"	0,30 mm	OZ-520-022	OZ-520-072	OZ-520-422	–	OZ-520-822	–
		0,60 mm	–	OZ-520-073	–	–	–	–
		1,00 mm	OZ-520-122	OZ-520-172	OZ-520-522	OZ-520-572	OZ-520-922	OZ-520-972
		2,00 mm	–	OZ-520-173	–	–	–	–
	24 cm – 9½"	0,30 mm	OZ-520-024	OZ-520-074	OZ-520-424	–	OZ-520-824	–
		0,60 mm	–	OZ-520-075	–	–	–	–
		1,00 mm	OZ-520-124	OZ-520-174	OZ-520-524	–	OZ-520-924	–
2,00 mm		–	OZ-520-175	–	–	–	–	

Passende Bipolare Anschlusskabel auf Seite OZ- 18.

Suitable bipolar connecting cables on page OZ- 18.

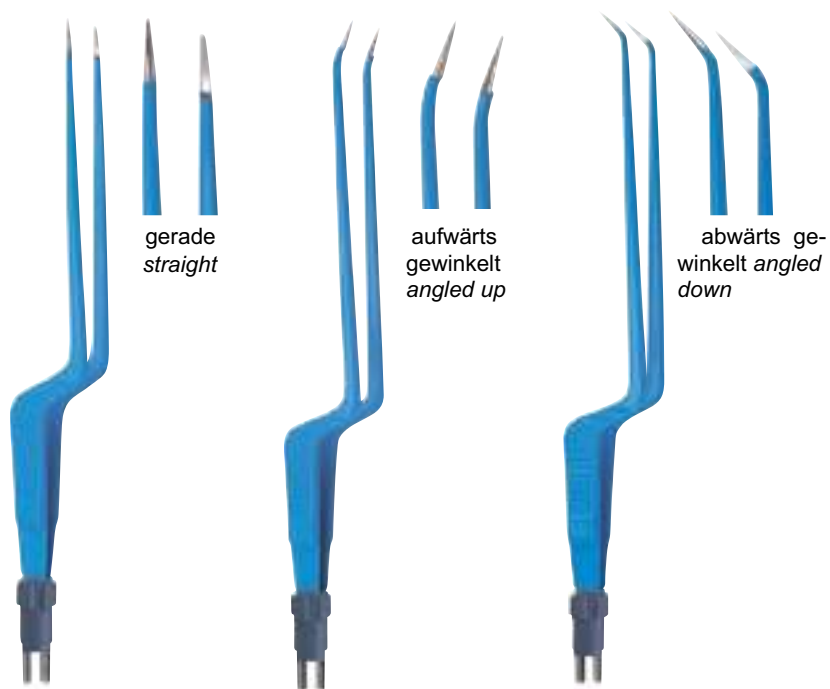
Bipolare Pinzetten Bipolar Forceps



Anschluss <i>Plug</i>	Länge <i>Length</i>	Spitzenbreite <i>Width of tips</i>	Standard	NON-STICK	Standard	NON-STICK	Standard	NON-STICK
	18 cm – 7"	0,30 mm	OZ-521-018	OZ-521-058	OZ-521-418	–	OZ-521-818	–
		0,60 mm	–	OZ-521-059	–	–	–	–
		1,00 mm	OZ-521-118	OZ-521-158	OZ-521-518	–	OZ-521-918	–
		2,00 mm	–	OZ-521-159	–	–	–	–
	20 cm – 8"	0,30 mm	OZ-521-020	OZ-521-070	OZ-521-420	–	OZ-521-820	–
		0,60 mm	–	OZ-521-071	–	–	–	–
		1,00 mm	OZ-521-120	OZ-521-170	OZ-521-520	OZ-521-570	OZ-521-920	OZ-521-970
		2,00 mm	–	OZ-521-171	–	–	–	–
	22 cm – 8¾"	0,30 mm	OZ-521-022	OZ-521-072	OZ-521-422	–	OZ-521-822	–
		0,60 mm	–	OZ-521-073	–	–	–	–
		1,00 mm	OZ-521-122	OZ-521-172	OZ-521-522	OZ-521-572	OZ-521-922	OZ-521-972
		2,00 mm	–	OZ-521-173	–	–	–	–
24 cm – 9½"	0,30 mm	OZ-521-024	OZ-521-074	OZ-521-424	–	OZ-521-824	–	
	0,60 mm	–	OZ-521-075	–	–	–	–	
	1,00 mm	OZ-521-124	OZ-521-174	OZ-521-524	–	OZ-521-924	–	
	2,00 mm	–	OZ-521-175	–	–	–	–	

2-Pin-Stecker (US-Standard).
Passende Bipolare Anschlusskabel auf Seite OZ- 18.

2-pin-plug (US-Standard).
Suitable bipolar connecting cables on page OZ- 18.

Bipolare Pinzetten

Bipolar Forceps

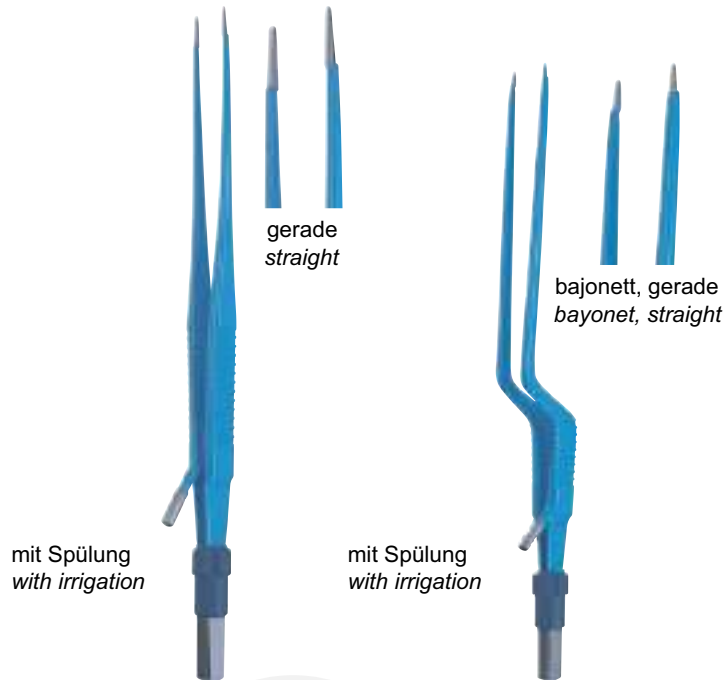



Anschluss Plug	Länge Length	Spitzenbreite Width of tips	Standard	Spitzenbreite Width of tips	Standard
	18cm – 7"	0,5 x 8 mm	OZ-530-018	0,5 x 8 mm	OZ-532-018
		1,0 x 8 mm	OZ-530-118	1,0 x 8 mm	OZ-532-118
		2,0 x 8 mm	OZ-530-218	1,5 x 8 mm	OZ-532-218
	20 cm – 8"	0,5 x 8 mm	OZ-530-020	0,5 x 8 mm	OZ-532-020
		1,0 x 8 mm	OZ-530-120	1,0 x 8 mm	OZ-532-120
		2,0 x 8 mm	OZ-530-220	1,5 x 8 mm	OZ-532-220
	22 cm – 8¾"	0,5 x 8 mm	OZ-530-022	0,5 x 8 mm	OZ-532-022
		1,0 x 8 mm	OZ-530-122	1,0 x 8 mm	OZ-532-122
		2,0 x 8 mm	OZ-530-222	1,5 x 8 mm	OZ-532-222
	24 cm – 9½"	–	–	0,5 x 8 mm	OZ-532-024
		–	–	1,0 x 8 mm	OZ-532-124
		–	–	1,5 x 8 mm	OZ-532-224

Passende Bipolare Anschlusskabel auf Seite OZ- 18.

Suitable bipolar connecting cables on page OZ- 18.

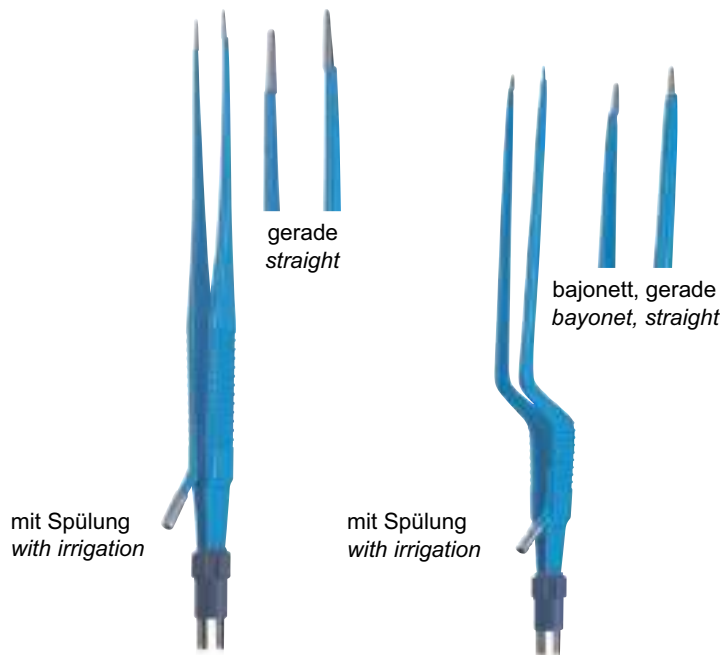
Bipolare Pinzetten Bipolar Forceps



Anschluss <i>Plug</i>	Länge <i>Length</i>	Spitzenbreite <i>Width of tips</i>	Standard	Spitzenbreite <i>Width of tips</i>	Standard
	18 cm – 7"	0,5 x 8 mm	OZ-531-018	0,5 x 8 mm	OZ-533-018
		1,0 x 8 mm	OZ-531-118	1,0 x 8 mm	OZ-533-118
		2,0 x 8 mm	OZ-531-218	1,5 x 8 mm	OZ-533-218
	20 cm – 8"	0,5 x 8 mm	OZ-531-020	0,5 x 8 mm	OZ-533-020
		1,0 x 8 mm	OZ-531-120	1,0 x 8 mm	OZ-533-120
		2,0 x 8 mm	OZ-531-220	1,5 x 8 mm	OZ-533-220
	22 cm – 8¾"	0,5 x 8 mm	OZ-531-022	0,5 x 8 mm	OZ-533-022
		1,0 x 8 mm	OZ-531-122	1,0 x 8 mm	OZ-533-122
		2,0 x 8 mm	OZ-531-222	1,5 x 8 mm	OZ-533-222
	24 cm – 9½"	–	–	0,5 x 8 mm	OZ-533-024
		–	–	1,0 x 8 mm	OZ-533-124
		–	–	1,5 x 8 mm	OZ-533-224

2-Pin-Stecker (US-Standard).
Passende Bipolare Anschlusskabel auf Seite OZ- 18.

2-pin-plug (US-Standard).
Suitable bipolar connecting cables on page OZ- 18.



Bipolare Pinzetten Bipolar Forceps

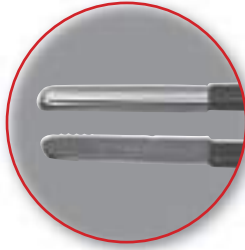

TC
Hartmetall
Tungsten Carbide

Allgemein
Merkmale unserer bipolaren Pinzetten,
isoliert, mit **TC**-Einlage:

Sicheres Fassen
Praktisch kein Anhaften von Gewebe
Sehr guter Gefäßverschluss

General information
Features of our bipolar forceps,
insulated, with **TC** insert:

Safe grasping
Virtually no tissue sticking
Excellent vessel closure



Anschluss Plug	Spitzenbreite Width of tips	16,5 cm – 6½"	22 cm – 8¾"	25 cm – 10"	30 cm – 11¾"
	2,2 mm	OZ- 4302-46	OZ- 4302-52	OZ- 4302-55	OZ- 4302-57

Passende Bipolare Anschlusskabel auf Seite HF 18.

Suitable bipolar connecting cables on page HF 18.

Bipolare Pinzetten Bipolar Forceps

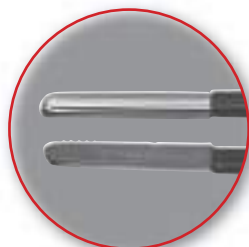

TC
Hartmetall
Tungsten Carbide

Allgemein

Merkmale unserer bipolaren Pinzetten, isoliert, mit **TC**-Einlage:

Sicheres Fassen
Praktisch kein Anhaften von Gewebe
Sehr guter Gefäßverschluss

General information

Features of our bipolar forceps, insulated, with **TC** insert:

Safe grasping
Virtually no tissue sticking
Excellent vessel closure



Anschluss Plug	Spitzenbreite Width of tips	19 cm – 7½"	19 cm – 7½"
	2,2 mm	OZ-4302-76	OZ-4302-82

Passende Bipolare Anschlusskabel auf Seite HF 18.

Suitable bipolar connecting cables on page HF 18.

Bipolare Anschlusskabel Bipolar Connecting Cables

für bipolare Pinzetten
for bipolar forceps

Flachstecker
Flat plug

2-Pin Stecker US-Standard
2-pin plug US-Standard



Gerätestecker Plug, generator side	Länge Length		Länge Length	
 Valleylab, Birtcher, Conmed, Bovie	3 m	OZ-310-103	4 m	OZ-310-3031
	5 m	OZ-310-105	-	-
 Erbe ACC / ICC, Storz	3 m	OZ-310-113	3 m	OZ-310-313
	5 m	OZ-310-115	5 m	OZ-310-315
 Martin, Berchtold, Aesculap	3 m	OZ-310-123	3 m	OZ-310-323
	5 m	OZ-310-125	5 m	OZ-310-325
 Valleylab, Lamidey, EMC	3 m	OZ-310-133	3 m	OZ-310-333
	5 m	OZ-310-135	5 m	OZ-310-335



©ZZE MEDICAL & SURGICAL SUPPLIES

TOOLS TO OPERATE

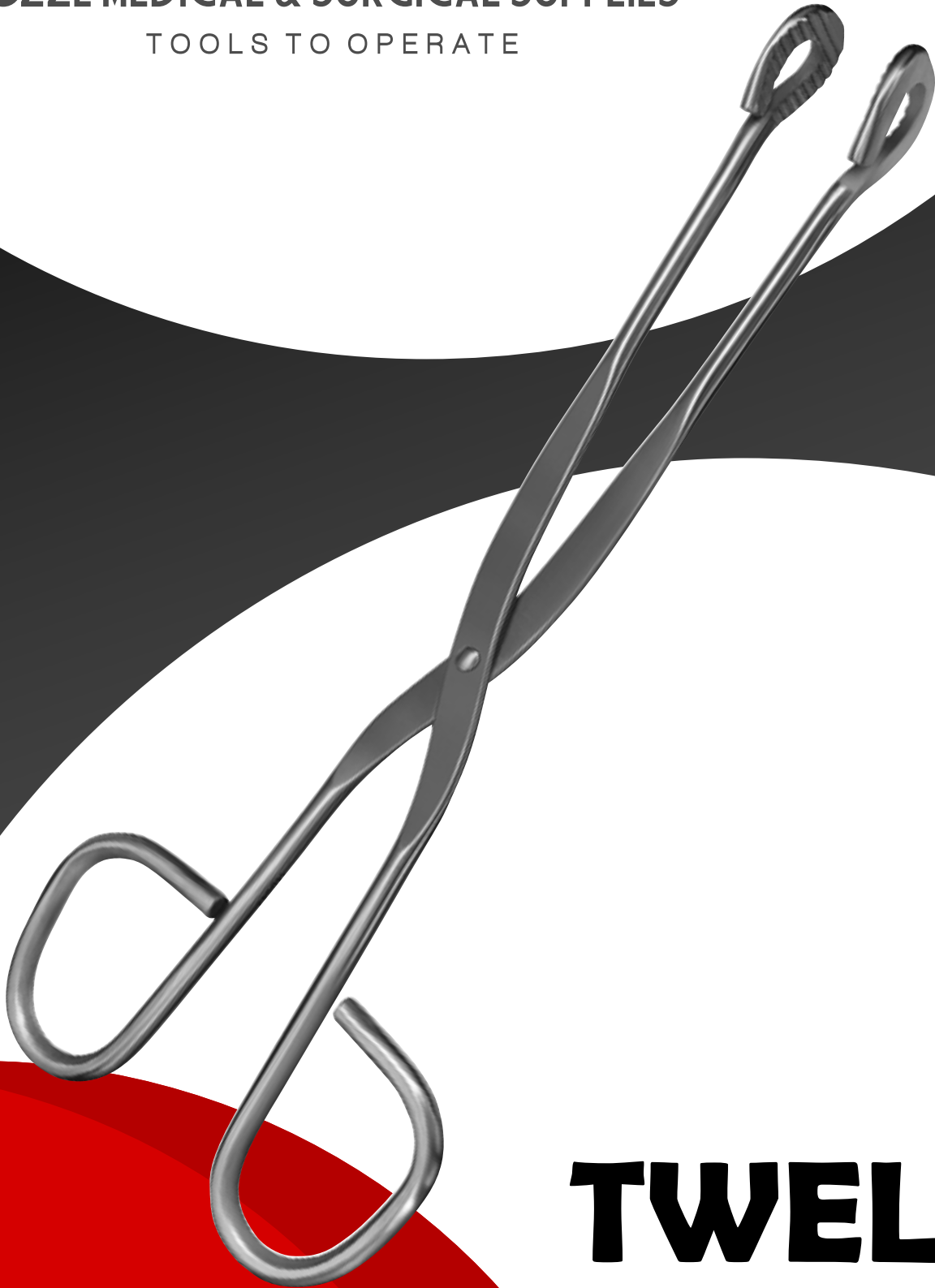

TWELVE

 www.ozzesurgical.com.au

 info@ozzesurgical.com.au

Hygiene und Aufbewahrung

Hygiene and Storage

Sterilisierzangen	<i>Sterilization Forceps</i>	HS 1
Dreieckschalen und Stechbecken	<i>Triangular Bowls and Bed Pans</i>	HS 2
Messbecher und Nierenschalen	<i>Measuring Jugs and Kidney Bowls</i>	HS 3
Behälter, rund	<i>Bowls, Round</i>	HS 4 - 6
Instrumentenschalen	<i>Instrument Trays</i>	HS 7 - 8
Siebkörbe, Größe 1/2	<i>Baskets, Half Size</i>	HS 9
Siebkörbe, Größe 3/4	<i>Baskets, Three-Quarter Size</i>	HS 10
Siebkörbe, Größe 1/1	<i>Baskets, Full Size</i>	HS 11
Siebkörbe, Größe Mini	<i>Baskets, Mini Size</i>	HS 12 - 13
Zubehör	<i>Accessories</i>	HS 14 - 15
Bereitstellungstische, Regalwagen	<i>Trolleys</i>	HS 16 - 17



Sterilisierzangen Sterilization Forceps



Abfallzange
Waste forceps

55 cm – 21¾"
1:5 **OZ-8941-55**

SAUERBRUCH



20 cm – 8"
OZ-8945-20

30 cm – 11¾"
OZ-8945-30



27 cm – 10½"
1:3 **OZ-8947-27**

CHEATLE

Sterilisierklammern
Sterilization clamps



UNIVERSAL



20 cm – 8"
OZ-8948-20

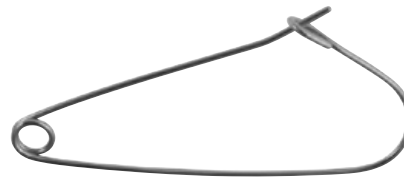

BUNT
10,5 cm – 4¼"
OZ-8950-01

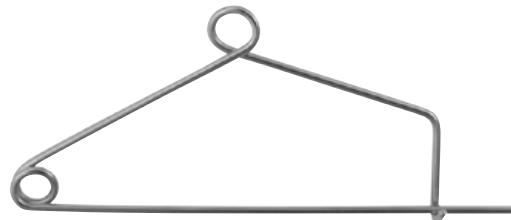

MAYO
14 cm – 5½"
OZ-8950-02

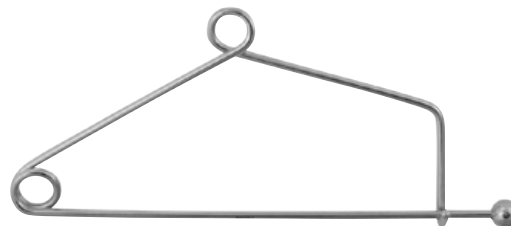

MAYO
14 cm – 5½"
OZ-8950-03

Dreieckschalen und Stechbecken
Triangular Bowls and Bed Pans

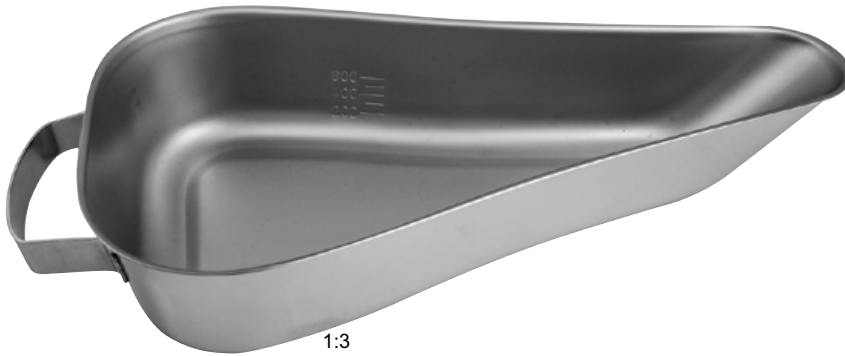

Dreieckschale mit Griff
Triangular bowl with handle

OZ-8960-01



Dreieckschale
Triangular bowl

OZ-8960-02

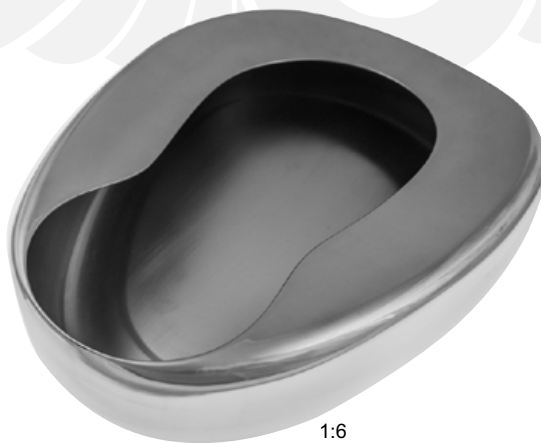

Stechbecken, amerikanische Form
Bed pan (American pattern)

350 x 290 x 90,5 mm

OZ-8960-05



Stechbecken
Bed pan

230 x 70 mm

310 x 82 mm

OZ-8961-01

OZ-8961-02

Measuring Jugs and Kidney Bowls Messbecher und Nierenschalen



	Messbecher <i>Measuring jugs</i>
0,25 l	OZ- 8964-02
0,50 l	OZ- 8964-05
1,00 l	OZ-8964-10
1,50 l	OZ-8964-15
2,00 l	OZ-8964-20



		Nierenschalen <i>Kidney bowls</i>
0,25 l	170 x 36 mm	OZ-8970-01
0,50 l	250 x 32 mm	OZ-8970-02
0,75 l	275 x 45 mm	OZ-8970-03

Runde Behälter Round Bowls



	Wattespender <i>Cotton dispensers</i>
85 x 85 mm	OZ-8972-01
100 x 100 mm	OZ-8972-02
120 x 120 mm	OZ-8972-03
150 x 150 mm	OZ-8972-04



	Medizinbecher <i>Medicine cups</i>
25 cc	OZ-8975-05
50 cc	OZ-8975-10



	Medizinbecher <i>Medicine cups</i>
100 cc = 0,10 l	OZ-8975-10/10
250 cc = 0,25 l	OZ-8975-10/25



1:3

	Septumbecher <i>Septum cups</i>
85 x 85 mm	
	OZ-8976-20



Runde Behälter Round Bowls



1:3

\varnothing x H \varnothing x h	Standgefäße Jars
30 x 80 mm	OZ-8984-01
35 x 100 mm	OZ-8984-02
50 x 120 mm	OZ-8984-03
60 x 130 mm	OZ-8984-04
75 x 140 mm	OZ-8984-05
75 x 175 mm	OZ-8984-06
100 x 150 mm	OZ- 8984-07



1:3

\varnothing x H \varnothing x h	Liter Litre	Schalen Bowls
40 x 19 mm	0,05 l	OZ- 8985-10
61 x 30 mm	0,07 l	OZ-8985-11
80 x 40 mm	0,14 l	OZ-8985-01
116 x 50 mm	0,35 l	OZ-8985-02
128 x 55 mm	0,45 l	OZ- 8985-03
147 x 65 mm	0,70 l	OZ-8985-04
167 x 75 mm	1,10 l	OZ-8985-05
187 x 85 mm	1,60 l	OZ-8985-06

Runde Behälter Round Bowls



Ø x HØ x h	Schalen Bowls
120 x 35 mm	OZ-8986-12
140 x 35 mm	OZ-8986-14
160 x 35 mm	OZ-8986-16



Typ Type	Ø x HØ x h	Liter Litre	Schalen Bowls
B1	40 x 19 mm	0,02 l	OZ-8987-01
B2	61 x 30 mm	0,06 l	OZ-8987-02
B4	83 x 41 mm	0,16 l	OZ-8987-03
B6	111 x 56 mm	0,40 l	OZ-8987-04
B8	151 x 73 mm	1,00 l	OZ-8987-05 OZ-8987-06
B10	211 x 76 mm	2,50 l	



Ø x HØ x h	Liter Litre	Schalen Bowls
165 x 55 mm	0,75 l	OZ-8988-01
175 x 70 mm	1,00 l	OZ-8988-02
225 x 100 mm	2,00 l	OZ-8988-03
240 x 90 mm	2,75 l	OZ-8988-04
260 x 120 mm	4,00 l	OZ-8988-05
315 x 105 mm	5,50 l	OZ-8988-06
325 x 135 mm	8,00 l	OZ-8988-07
380 x 130 mm	11,00 l	OZ-8988-08
405 x 150 mm	14,00 l	OZ-8988-09

Instrumentenschalen Instrument Trays



	Instrumentenablageplatten <i>Instrument storage trays</i>
160 x 210 x 10 mm	OZ-8977-01
240 x 180 x 10 mm	OZ-8977-02
280 x 210 x 10 mm	OZ-8977-03
300 x 160 x 10 mm	OZ-8977-04
310 x 210 x 10 mm	OZ-8977-05
400 x 270 x 10 mm	OZ-8977-06



L x B x H / x b x h	Schalen <i>Trays</i>
330 x 230 x 30 mm	OZ-8978-01
350 x 250 x 30 mm	OZ-8978-02
350 x 250 x 50 mm	OZ-8978-04



Instrumentenkasten
Instrument box

205 x 105 x 40 mm

OZ-8979-00

Instrumentenschalen Instrument Trays



L x B x H / l x b x h	Instrumentenkasten <i>Instrument box</i>
165 x 90 x 35 mm	OZ-8980-01
200 x 100 x 50 mm	OZ-8980-02
220 x 150 x 50 mm	OZ-8980-03
260 x 150 x 50 mm	OZ-8980-04
305 x 205 x 50 mm	OZ-8980-05
420 x 80 x 40 mm	OZ-8980-06



Schalen
Trays

235 x 190 x 40 mm
OZ-8989-00

Siebkörbe, Größe 1/2 Baskets, Half Size

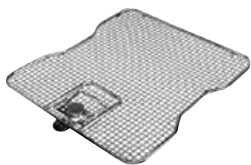

Deckel für Drahtsiebkorb
Lid for wire basket

240 x 215 mm **OZ-140-000**

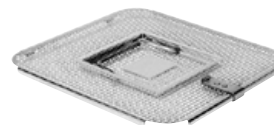

Deckel für Siebkorb
Lid for perforated basket

240 x 240 mm **OZ-141-000**



Drahtsiebkorb
Wire basket

255 x 245 x 30 mm **OZ-140-030**

255 x 245 x 50 mm **OZ-140-050**

255 x 245 x 70 mm **OZ-140-070**

255 x 245 x 100 mm **OZ-140-100**



Siebkorb
Perforated basket

240 x 240 x 41 mm **OZ-141-041**

240 x 240 x 45 mm **OZ-141-045**

240 x 240 x 50 mm **OZ-141-050**

240 x 240 x 70 mm **OZ-141-070**

240 x 240 x 90 mm **OZ-141-090**



Spannrahmen für Drahtsiebkorb
Drape retainer for wire basket

255 x 255 mm **OZ-146-000**



Silikon-Noppenmatte für
Drahtsiebkorb und Siebkorb
Silicone stud mat for baskets

240 x 220 mm **OZ-147-001**



Füße (Kunststoff), für Drahtsiebkorb
Feet (Plastic), for wire basket

4 Stk./pcs. **OZ-141-100**

Siebkörbe, Größe 3/4 Baskets, Three-Quarter Size



Deckel für Drahtsiebkorb
Lid for wire basket

375 x 240 mm **OZ-240-000**

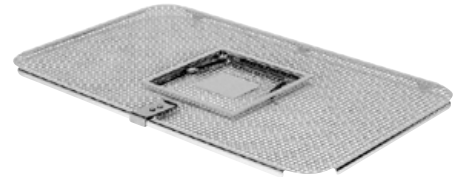

Deckel für Siebkorb
Lid for perforated basket

380 x 240 mm **OZ-241-000**

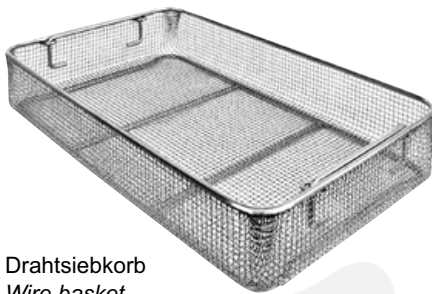

Drahtsiebkorb
Wire basket

405 x 255 x 30 mm **OZ-240-030**

405x 255 x 50 mm **OZ-240-050**

405x 255 x 70 mm **OZ-240-070**

405 x 255 x 100 mm **OZ-240-100**

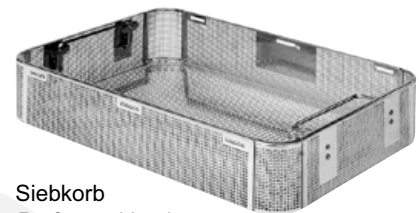

Siebkorb
Perforated basket

380 x 240 x 41 mm **OZ-241-041**

380 x 240 x 45 mm **OZ-241-045**

380 x 240 x 50 mm **OZ-241-050**

380 x 240 x 70 mm **OZ-241-070**

380 x 240 x 90 mm **OZ-241-090**

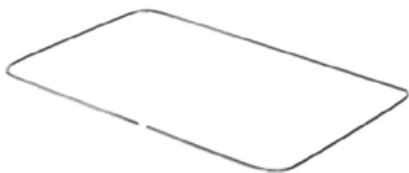

Spannrahmen für Drahtsiebkorb
Drape retainer for wire basket

405 x 255 mm **OZ-246-000**



Silikon-Noppenmatte für
Drahtsiebkorb und Siebkorb
*Silicone stud mat for wire basket
and perforated basket*

380 x 220 mm **OZ-247-000**



Füße (Kunststoff), für Drahtsiebkorb
Feet (Plastic), for wire basket

4 Stk./pcs. **OZ-141-100**

Siebkörbe, Größe 1/1 Baskets, Full Size

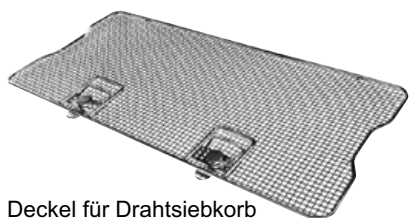

Deckel für Drahtsiebkorb
Lid for wire basket

455 x 240 mm **OZ-340-000**

510 x 240 mm **OZ-341-000**

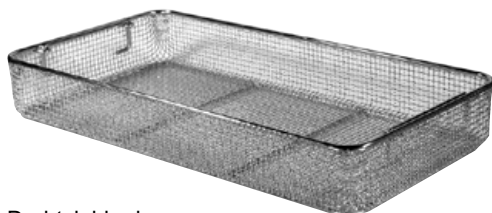

Drahtsiebkorb
Wire basket

485 x 255 x 30 mm **OZ-340-030**

485 x 255 x 50 mm **OZ-340-050**

485 x 255 x 70 mm **OZ-340-070**

485 x 255 x 100 mm **OZ-340-100**

540 x 255 x 30 mm **OZ-341-030**

540 x 255 x 50 mm **OZ-341-050**

540 x 255 x 70 mm **OZ-341-070**

540 x 255 x 100 mm **OZ-341-100**

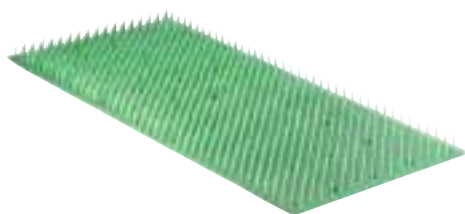

Silikon-Noppenmatte für
Drahtsiebkorb und Siebkorb
*Silicone stud mat for wire basket
and perforated basket*

480 x 220 mm **OZ-347-000**

500 x 220 mm **OZ-348-000**

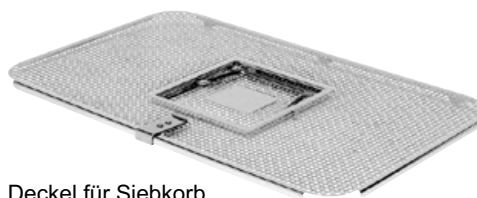

Deckel für Siebkorb
Lid for perforated basket

480 x 240 mm **OZ-342-000**

510 x 240 mm **OZ-343-000**

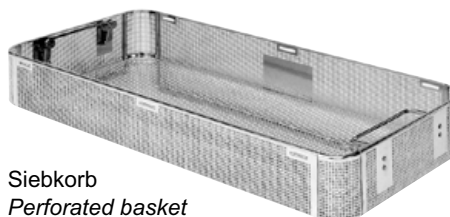

Siebkorb
Perforated basket

480 x 240 x 41 mm **OZ-342-041**

480 x 240 x 45 mm **OZ-342-045**

480 x 240 x 50 mm **OZ-342-050**

480 x 240 x 70 mm **OZ-342-070**

480 x 240 x 90 mm **OZ-342-090**

540 x 240 x 41 mm **OZ-343-041**

540 x 240 x 45 mm **OZ-343-045**

540 x 240 x 50 mm **OZ-343-050**

540 x 240 x 70 mm **OZ-343-070**

540 x 240 x 90 mm **OZ-343-090**

540 x 240 x 70 mm **OZ-343-180**

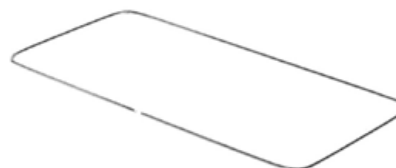

Spannrahmen für Drahtsiebkorb
Drape retainer for wire basket

545 x 255 mm **OZ-346-000**



Füße (Kunststoff), für Drahtsiebkorb
Feet (Plastic), for wire basket

4 Stk./pcs. **OZ-141-100**



OZZE MEDICAL & SURGICAL SUPPLIES
TOOLS TO OPERATE

Siebkörbe, Größe Mini Baskets, Mini Size



Drahtsiebkorb
Wire basket

265 x 120 x 45 mm

OZ-540-045



Spannrahmen für Drahtsiebkorb
Drape retainer for wire basket

300 x 140 mm

OZ-546-000



Silikon-Noppenmatte für
Drahtsiebkorb und Siebkorb
*Silicone stud mat for wire basket
and perforated basket*

300 x 140 mm

OZ-547-000



Füße (Kunststoff), für Drahtsiebkorb
Feet (Plastic), for wire basket

4 Stk./pcs.

OZ-141-100



Siebkörbe, Größe Mini Baskets, Mini Size



Minikorb mit Deckel
Mini basket with lid

- 1 Instrumentenhalter im Deckel
- 2 Instrumentenhalter im Körper
- 1 Instrument holder in the lid*
- 2 Instrument holders in the basket*

170 x 50 x 30 mm **OZ-050-001**



Minikorb mit Deckel
Mini basket with lid

- 2 Instrumentenhalter im Deckel
- Silikon-Noppenmatte im Körper
- 2 Instrument holders in the lid*
- Silicone mat in the basket*

170 x 50 x 30 mm **OZ-050-002**



Minikorb mit Deckel
Mini basket with lid

- 1 Instrumentenhalter im Deckel
- 2 Instrumentenhalter im Körper
- 1 Instrument holder in the lid*
- 2 Instrument holders in the basket*

240 x 240 x 35 mm **OZ-050-005**



Minikorb mit Deckel
Mini basket with lid

- 1 Instrumentenhalter im Deckel
- Silikon-Noppenmatte im Körper
- 1 Instrument holder in the lid*
- Silicone mat in the basket*

135 x 170 x 35 mm **OZ-050-003**

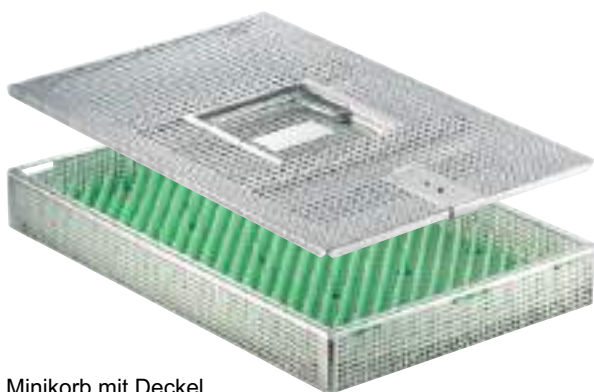

Minikorb mit Deckel
Mini basket with lid

- 2 Instrumentenhalter im Deckel
- Silikon-Noppenmatte im Körper
- 2 Instrument holders in the lid*
- Silicone mat in the basket*

270 x 170 x 35 mm **OZ-050-004**

Zubehör Accessories



Verschlussplombe
Seal

1000 Stück / Packung
1000 pieces / package

OZ-950-028



Entsorgungsmarke
für Drahtsiebkörbe

*Metal label for
wire basket*

unbeschriftet
unlabeled

OZ-961-020



Entsorgungsmarke
für Drahtsiebkörbe

*Metal label for
wire basket*

beschriftet
labeled

OZ-961-021



Karabinerhaken
Carabiner



OZ- 8906-01



Edelstahlplakette
Ø 20 mm
*Stainless steel tag
Ø 20 mm*

OZ-961-030

Identifikationsklebebänder autoklavierbar
6,4 mm breit / 7,62 m pro Rolle Identification
adhesive tape, autoclavable
6.4 mm wide / 7.62 m per roll

rot – red		OZ- 8884-01	
gelb – yellow		OZ- 8884-02	orange
orange –		OZ-8884-03	
blau – blue		OZ-8884-04	
grün – green		OZ-8884-05	
braun – brown		OZ-8884-06	
weiß – white		OZ-8884-07	
schwarz – black		OZ-8884-08	
violett – violet		OZ-8884-09	

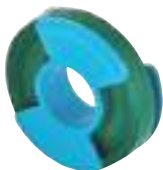

Zubehör Accessories



Sortierspieß
Holding pin

OZ-956-001



Trennblechhaltestift
Partition holding pin

OZ-956-002



Trennblech
Partition sheet

50 x 20 mm	OZ-956-010
130 x 20 mm	
225 x 20 mm	
460 x 20 mm	



Fixierklammer
Fixation clamp

24 x 28 x 25 mm	Ø 7 x 12 mm	OZ-961-011
24 x 28 x 29 mm	Ø 12 x 16 mm	OZ-961-012
24 x 28 x 31 mm	Ø 16 x 26 mm	OZ-961-013
24 x 28 x 40 mm	Ø 26 x 36 mm	OZ-961-014
24 x 28 x 44 mm	Ø 36 x 45 mm	OZ-961-015



Tuchklammer
Drape clamp

OZ-961-010



Doppelte Spiralfeder
Double spiral holder

OZ-956-021



Spiralfeder
Spiral holder

OZ-956-020



Einschlagtuch aus Baumwolle
Wrapping drape, cotton

60 x 40 cm	OZ-8906-31
90 x 40 cm	OZ-8906-32
130 x 40 cm	OZ-8906-33
85 x 85 cm	OZ-8906-34
130 x 85 cm	OZ-8906-35
160 x 80 cm	OZ-8906-36
160 x 100 cm	OZ-8906-37
160 x 160 cm	OZ-8906-38
240 x 160 cm	OZ-8906-39

Bereitstellungstische Trolleys



Sterilgut-Bereitstellungstisch, mobil,
für 1 großen Container
Tischplatte 660 x 400 mm
Gesamthöhe 850 mm
- Lagerungsschienen für Deckelablage
- 1 Regalboden
- Rollen mit Feststellbremse

*Sterile good table, mobile,
for 1 full size container table
surface 660 x 400 mm total
height 850 mm*

- deposit rails for container lid
- 1 shelf
- wheels with fixing brake

OZ-980-010



Sterilgut-Bereitstellungstisch, mobil,
für 2 große Container
Tischplatte 660 x 640 mm
Gesamthöhe 850 mm
- Lagerungsschienen für Deckelablage
- 1 Regalboden
- Rollen mit Feststellbremse

*Sterile good table, mobile,
for 2 full size containers table
surface 660 x 640 mm total
height 850 mm*

- deposit rails for container lids
- 1 shelf
- wheels with fixing brake

OZ-980-011



Sterilgut-Regalwagen, offen
1165 x 700 mm (L x B) Gesa-
mthöhe 1310 mm - 4 Regal-
böden

- Rollen mit Feststellbremse

Sterile good transport trolley, open

1165 x 700 mm (l x w)

total height 1310 mm

- 4 shelves

- wheels with fixing brake

OZ-980-012



Sterilgut-Regalwagen, geschlossen

1190 x 720 mm (L x B)

Gesamthöhe 1465 mm

- 2 Regalböden

- Rollen mit Feststellbremse

Sterile good transport trolley, closed

1190 x 720 mm (l x w)

total height 1465 mm

- 2 shelves

- wheels with fixing brake

OZ-980-013



©ZZE MEDICAL & SURGICAL SUPPLIES

TOOLS TO OPERATE



©ZZE MEDICAL & SURGICAL SUPPLIES

TOOLS TO OPERATE



THIRTEEN

🖱 www.ozzesurgical.com.au

✉ info@ozzesurgical.com.au



Elevators

Adson Periosteal Elevator

- 16cm/6¼" length
- Curved blunt

	Width
OZ-3055-16	5mm
OZ-3007-16	7mm



Pennybacker Periosteal Elevator

- 16cm/6¼" length
- Curved sharp

	Width
OZ-3064-16	4mm
OZ-3066-16	6mm
OZ-3068-16	8mm



Bone Raspatory with Tufnol Handle

- 19cm/7½" length



	Straight 6mm	Width
OZ-7016-19		

	Curved 3mm	Width
OZ-7023-19		
OZ-7026-19		6mm

Farabeuf Rugine Elevator

- 15cm/6" length

	Straight 12mm	Width
OZ-3001-15		

	Curved* 12mm	Width
OZ-3002-15		



*illustrated

Farabeuf Rugine Elevator with Hollow Handle

- 16cm/6¼" length

	Straight 12mm	Width
OZ-3011-16		

	Curved* 12mm	Width
OZ-3012-16		



*illustrated



Elevators

Trethowan Bone Elevator

- 22.5cm/8½" length

OZ-3030-22



Lanes Bone Elevator

- 26cm/10" length

OZ-3031-26



Fagge Bone Elevator

- 27.5cm/10¾" length

OZ-3032-27



Bristow Periosteal Elevator

- 23cm/9" length
- Curved sharp
- 10mm width

OZ-3003-23



Femoral Dislocation Lever

- 31cm/12½" length
- 26mm width

OZ-3026-31



Muller Femoral Retractor

- 35cm/13½" length
- 28mm width

OZ-3028-35



For retraction of the femoral neck.

Mini Elevators

Mini Bone Lever

- 14cm/5½"
- 2.8mm width

OZ-5830-14



Hohmann Style Mini-Bone Lever

- 16cm/6¼"
- 6mm width

OZ-5831-16



Phalangeal Lever

- 15cm/6"
- 5mm width

OZ-5832-16



Buck-Gramcko Lever

- 15cm/6"
- 7.5mm width

OZ-5833-15



Mini-Cobra Bone Lever

- 16cm/6¼"
- 15mm width

OZ-5834-16



McGlamry Metatarsal Elevator

- 17cm/6½"
- Sharp

Width

OZ-5835-10	9mm
OZ-5835-12	11mm
OZ-5835-14	13mm
OZ-5835-16	15mm
OZ-5835-19	19mm





Elevators

Hohmann Bone Elevator

- 22cm/8½" length
- 8mm width

OZ-3008-22



Hohmann Bone Elevator

- 24cm/9½" length
- 18mm width

OZ-3018-24



Hohmann Bone Elevator

- 24.5cm/9½" length
- 43mm width

OZ-3043-24



Hohmann Large Bone Elevator

- 24cm/9½" length
- 70mm width

OZ-3070-24



Hohmann Bone Elevator

- 28cm/11" length
- 33mm width

OZ-3033-28



Hohmann Bone Elevator

- 26cm/10" length
- 24mm width

OZ-3024-26





Elevators

Long Curved Hohmann Inferior Hip Elevator

- 40cm/16" length
- 22mm width

OZ-3022-40



Modified Hohmann Elevator

- 90° angled

Width

OZ-7750-10	10mm
OZ-7750-18	18mm
OZ-7750-25	25mm
OZ-7750-43	43mm
OZ-7750-70	70mm



Modified Cobra Aufrang Elevator

- 33cm/13" long blade
- 30mm x 100mm

OZ-7742-10



Shallow Bone Elevator

- 25cm/9 3/4" length

OZ-7755-25



Concave Moor Elevator

- 33cm/13" long blade

OZ-7742-20



Elevators

Murphy Bone Skid Elevator

- 23cm/9" length
- For dislocation of the femoral head
- Double ended

OZ-0589-23



Murphy Insulated Bone Skid Elevator

- 33cm/13" length
- Double ended

OZ-3035-33



Infero-Posterior Acetabular Capsule Retractor

- 35cm/14" length

Right

OZ-7772-10

Left

OZ-7772-20



PCL Retractor

- 25cm/10" length
- To straddle the cruciate ligament
- 4mm wide prongs
- 21mm wide tips

OZ-7761-10



Wide Prong PCL Retractor

- 25cm/10" length
- To straddle the cruciate ligament
- 5mm wide prongs
- 23mm wide tips

OZ-7762-10





Bone Hooks

- Bone Hook Sharp
- 24.5cm/9¾" length
 - Sharp

OZ-9050-24



- Blunt Hook
- 20cm/8" length

OZ-9051-20



- Wroblenski Dislocating Hook

- 25cm/10" length
- For hooking around the neck of the Femur

OZ-9055-25



- McMinn Dislocating Hook

- 25cm/10" length
- Blunt hook with Tufnol handle

OZ-9057-25





Bone Spreaders

Scaphoid Spreader - Fine Pattern

- 14cm/5½" length
- 1 x 2 prongs

6mm

OZ-5131-14



Scaphoid Spreader - Standard Pattern

- 14cm/5½" length

6mm

OZ-5134-14



Baby Inge Bone Spreader

- 18cm/7" length

7mm
Toothed



OZ-5134-18

7mm
Smooth



OZ-5134-18S

7mm
Cross Serrated



OZ-5134-18X

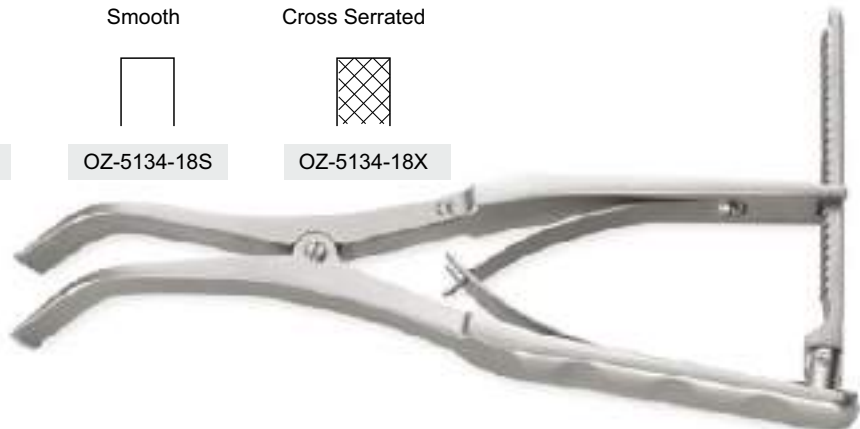

Scaglietti Lamina Spreader

- 28cm/11" length
- With speed lock



OZ-2009-28





Bone Cutters

Bohler Bone Cutters

- 15cm/6" length
- Double action

Straight

OZ-5160-50

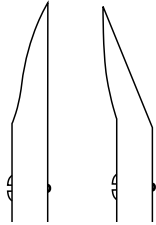

Angled

OZ-5161-50



McIndoe Bone Cutters

- 18cm/7" length
- Double action
- Angled jaws

OZ-1028-18



Ruskin-Liston Bone Cutters

- 19cm/7½" length
- Double action

Straight

OZ-5170-19

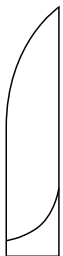

Angled

OZ-5171-19



Stille-Liston Bone Cutters

- 27cm/10¾" length
- Double action

Straight

OZ-1024-27



Angled

OZ-1025-27



Liston-Key-Horsley Bone Cutters

- 27cm/10¾" length
- Double action
- Angled

OZ-1023-27





OZZE MEDICAL & SURGICAL SUPPLIES

TOOLS TO OPERATE

Bone Nibblers

Kleinert-Kutz Bone Nibbler

- 14cm/4½" length
- Curved

2mm Bite

OZ-5118-50



Lempert Bone Nibbler

- 19cm/7½" length
- Single action

3mm Bite

OZ-1001-19



Luer Bone Nibbler

- 18cm/7" length
- Single action

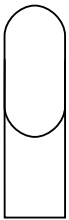

Straight
8mm Bite

OZ-1004-18



Curved 8mm
Bite

OZ-1005-18



Adsons Bone Nibbler

- 20cm/8" length
- Single action

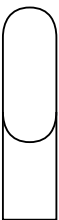

7mm Bite

OZ-1040-20





Bone Nibblers

Bohler Bone Nibbler

- Curved double action
- 15cm/6"

- 3mm Bite

OZ-5120-50



Marquardt Bone Nibbler

- 20cm/8" length
- Curved double action

- 3mm Bite

OZ-1002-20

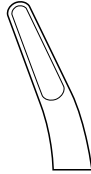

Beyer Bone Nibbler

- Curved double action
- 18cm/7"

- 4mm Bite

OZ-1002-18

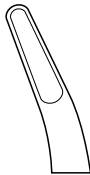

Jansen Bone Nibbler

- Curved double action
- 18cm/7"

- 5mm Bite

OZ-1003-18

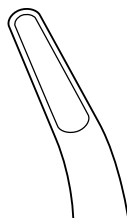



Bone Nibblers

Smith-Peterson Bone Nibbler

- 24cm/9½" length
- Double action

Straight Light Curve Bite Size

OZ-1010-24	OZ-1014-24	3mm
OZ-1011-24	OZ-1015-24	4mm
OZ-1012-24	OZ-1016-24	5mm
OZ-1013-24	OZ-1017-24	6mm

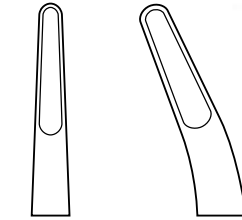

Straight Light Curve

Leksell Bone Nibbler

- 24cm/9½" length
- Double action angled

Angled Jaw Bite Size

OZ-1018-24	3mm
OZ-1019-24	5mm
OZ-1020-24	8mm

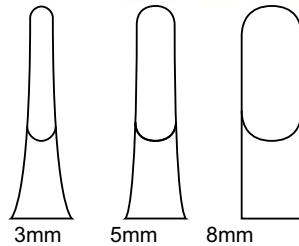

3mm 5mm 8mm

Stille-Luer Bone Nibbler

- 22cm/8¾" length
- Double action

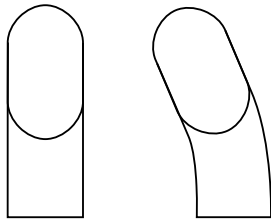

Straight
10mm Bite
OZ-1006-22

Curved
10mm Bite
OZ-1007-22



'Mr Blobby' Stille-Luer Bone Nibbler

- 26cm/10¼" length
- Double action

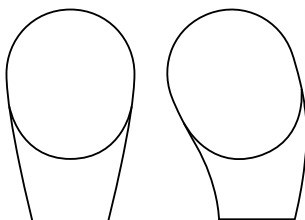

Straight
17mm Bite
OZ-1008-26

Curved
17mm Bite
OZ-1009-26



Bone Holding Forceps

Langenbeck Bone Holding Forceps

- 20cm/8" length

OZ-5120-05

5mm



Frosch Bone Holding Forceps

- 18cm/7" length
- Toothed/serrated jaws

OZ-6141-18



St. Thomas Bone Holding Forceps

- 18cm/7" length
- Screw joint

OZ-6170-18



Fergusson Bone Holding Forceps

- 20cm/8" length
- Screw joint

OZ-6140-20



Langenbeck Bone Holding Forceps

- 21cm/8 1/4" length

OZ-6144-21





Bone Holding Forceps

Trochanter Holding Forceps

- 21cm/9" length

OZ-6145-21



Semb Bone Holding Forceps

- 19cm/7½" length
- Angled to side

OZ-6147-18



Hey Groves Bone Holding Forceps

- Screw joints
- Serrated jaws

Length

OZ-6145-20	20cm/8"	Small
OZ-6145-25	25.5cm/10"	Medium
OZ-6145-30	30.5cm/12"	Large



Verbrugge Bone Holding Forceps

Length

OZ-6150-25	25cm/10"	Small
OZ-6150-26	26cm/10½"	Medium
OZ-6150-27	27cm/11"	Large



Hintermann Distractors

The Hintermann Distractor is used in foot and ankle surgery for bone distraction as an alternative to Lamina spreaders. The instrument can be locked and applies distraction across two K-wires placed on either side of a joint.

The spreader is then distracted, and locked when the required distance between the two bone fragments is reached.

Two K-wires (either 1.6 or 2.5mm Ø) are introduced into the correct holes in the spreading arms, and penetrate the bone at appropriate position into each of the two bone fragments to be distracted.

The Hintermann offers flexible positioning with the advantage of not interfering with the procedure.

These distractors are available in two different sizes (15cm or 21cm), and with closed or outspread arms, allowing them to fit different indications.

Hintermann Distractor with closed arms

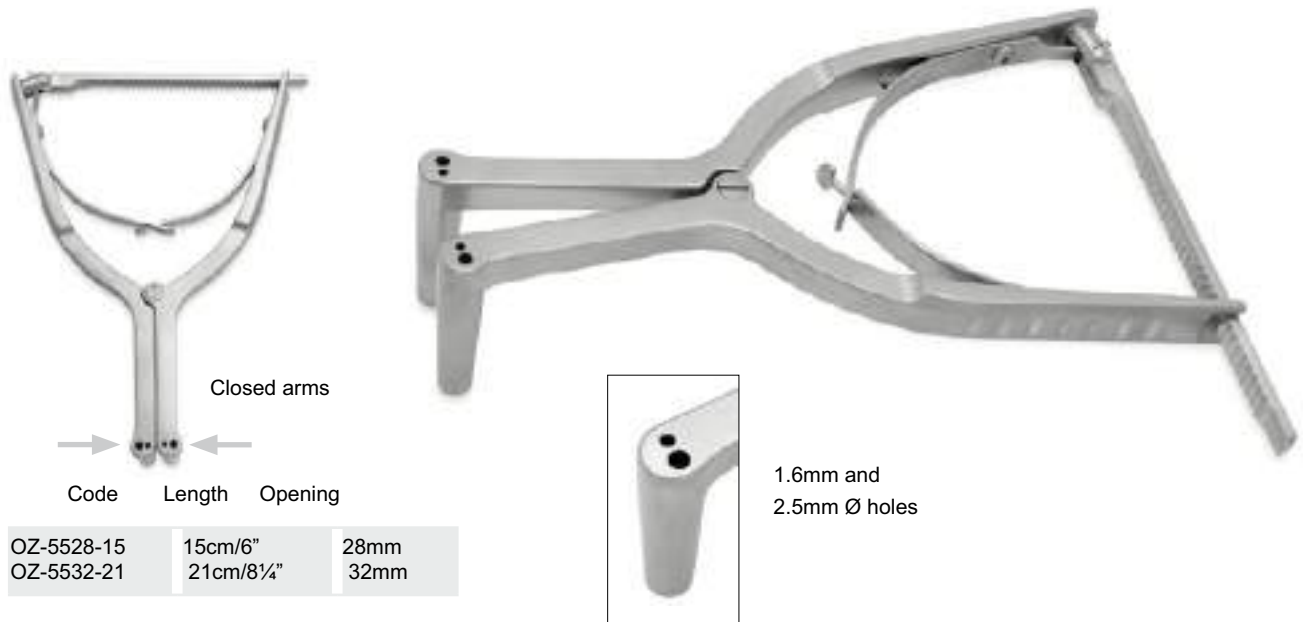

Hintermann Distractor with open arms - for wider distraction

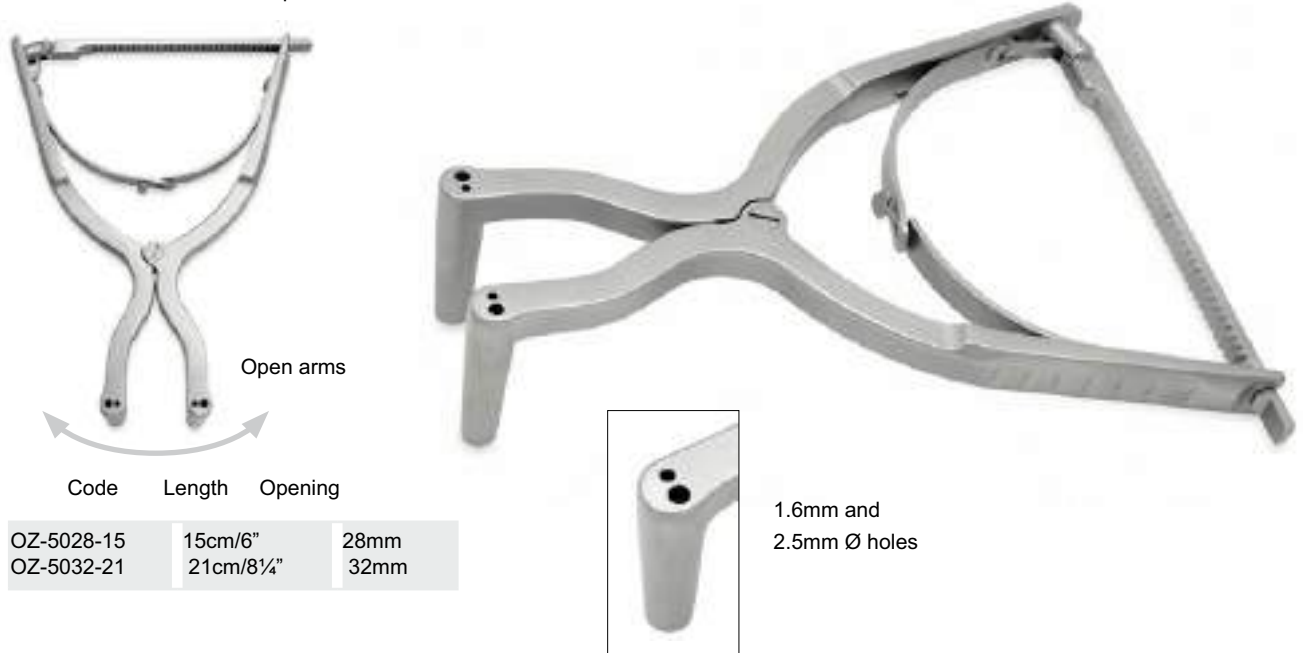



Pelvic Reduction Forceps

- 19cm/7½" length
- Angled, small
- Pointed ball tips
- Speed lock

OZ-6151-19



Pelvic Reduction Forceps

- 23cm/9" length
- Angled, large
- Pointed ball tips
- Speed lock

OZ-6152-23



Pelvic Reduction Forceps

- 25cm/10" length
- Straight, large
- Pointed ball tips
- Speed lock

OZ-6153-25



Pelvic Reduction Forceps

- 40cm/16" length
- Pointed ball tips
- Speed lock

OZ-6154-40



Pelvic Reduction Forceps

- 40cm/16" length
- 3 pointed ball tips
- Speed lock

OZ-6155-40





Retractors

Meyerding Retractor

- 22cm/9" length



Blade size

OZ-5050-22	50mm x 16mm
OZ-5075-22	70mm x 25mm
OZ-5090-22	90mm x 50mm

Langenbeck Retractor

- 21.5cm/8½" length



Blade size

OZ-5122-21	22mm x 6mm	Small
OZ-5145-21	45mm x 13mm	Medium
ZO-5165- 21	65mm x 25mm	Large
OZ-5190- 21	90mm x 20mm	Extra large

Volkman Catspaw Retractor

- | 21.5cm/8½" length
- | Semi sharp teeth



15 x 15mm 3 Prong

OZ-5015-21



15 x 20mm 4 Prong

OZ-5020-21

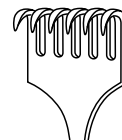

15 x 30mm 6 Prong

OZ-5030-21

Hip Retractors

Charnley Initial Incision Retractor Set



Frame only

OZ-4006-01

OZ-4006-00

Complete Set - Basic

Consisting of: •
1x Frame

- 1x Weight & chain
- 1x Square fitting blade - 50mm depth
- 1x Round fitting blade - 40mm depth

OZ-4006-05

Complete Set - Extended

Consisting of:

- 1x Frame
- 1x Weight & chain
- 3x Square fitting blades:
- 3x Round fitting blades:

50mm depth

40mm depth

75mm depth

75mm depth

100mm depth

100mm depth

Blade with Square Fitting



OZ-4006-50

Standard depth 50mm

OZ-4006-75

Extra depth 75mm

OZ-4006-10

Extra, extra depth 100mm

Blade with Round Fitting



OZ-4007-40

Standard depth 40mm

OZ-4007-75

Extra depth 75mm

OZ-4007-10

Extra, extra depth 100mm

To spread the incision in the fascia lata. It is combined with a weight and chain, which tilts the retractor to an angle of 45° to improve exposure of the anterior aspect of the joint.



Weight & chain

OZ-4006-07



Retractors

West's S/R Retractor

- 14cm/5½" length
- 3x4 Sharp prongs

OZ-4003-14



Weitlaner S/R Retractor

- 14cm/5½" length
- 3x4 Blunt prongs

OZ-4002-14

Travers S/R Retractor

- 20cm/8" length
- 4x5 Blunt prongs

OZ-4004-20



Norfolk and Norwich S/R Retractor

- 20cm/8" length
- 4x5 Blunt prongs

OZ-4000-20



Gelpi Laminectomy Retractor

- Sharp prongs

	Length	Prong depth
OZ-4030-16	18.5cm/7¼"	30mm
OZ-4050-16	19.5cm/7¾"	50mm
OZ-4070-16	20cm/8"	70mm





Retractors

Chamley Vertical Retractor

- 24.5cm/9½" length
- 3x4 Sharp prongs
- Blade depth 22mm

OZ-4007-24



Cones Self Retaining Retractor

- 3x4 Prongs
- Jointed arms



Blunt Prongs	Length	Depth	Sharp Prongs	Length	Depth
OZ-4064-13	13cm/5"	15mm	OZ-4063-13	13cm/5"	15mm
OZ-4066-16	16cm/6½"	15mm	OZ-4065-16	16cm/6½"	15mm
OZ-4068-20	20cm/8"	20mm	OZ-4067-20	20cm/8"	20mm
OZ-4070-24	24cm/9½"	25mm	OZ-4069-24	24cm/9½"	25mm

Harvey Jackson Self Retaining Retractor

- 30.5cm/12" length
- Blade depth 45mm
- 3x3 Sharp prongs

OZ-4010-30



Retractors

Charnley Horizontal Hip Retractor

- 28cm/11" length
- Blade depth 18mm
- Hinged joint
- 7" opening

OZ-4006-28

To retract the detached trochanter headwards, and the femur towards the feet



Hardinge Horizontal Retractor

- Blade depth 18mm
- Hinged joint

OZ-4007-28



Charnley Pin Retractor

Complete set with:

- T-handle introducer
- Pair of pins with chains

OZ-1100-00

OZ-1101-00 T-handle only



Pair of pins with chain only

OZ-1102-00



One pin, or sometimes two, is driven into the bone of the superior lip of the acetabulum, to stake back the capsule to give a clear view of the superior lip of the acetabulum. The nerve supply to the tensor fasciae femoris is preserved in this exposure by restricting dissection in the cleft in front of the gluteus medius, but this restricts exposure. By using pins to stake back the abductor muscles, a good exposure of the acetabulum can be obtained, and at the same time the nerve supply to tensor fasciae femoris can be preserved.

The short pins do not obstruct the surgeon's hand in access to the acetabulum. The chain is a safety device to prevent the pins being left in situ.



Retractors

Viper Hinged Scoliosis Retractor

- 30cm/11¾" length
- Sharp

Depth Prongs

OZ-7248-38H	40mm
OZ-7248-40H	70mm
OZ-7248-50H	100mm



Viper Scoliosis Retractor

- 30cm/11¾" length
- Sharp prongs

OZ-7248-38	Depth Prongs
OZ-7248-40	40mm 70mm
OZ-7248-50	100mm



Mallets

Toffee Mallet

- | 19cm/7½" length
- | Head size 22mm Ø
- | Weight 165g/6oz

OZ-5808-21



Ultra Fine Mallet

- | 17cm/6¾" length
- | Head size 20mm Ø
- | Weight 145g/5oz

OZ-5801-17



Heath Mallet

- 19cm/7" length
- Stainless steel head
- Head size 40mm Ø
- Weight 1020g/36oz

OZ-5809-19



Mallet with Tufnol Handle

- 23cm/9" length
- Small head size 30mm Ø
- Weight 350g/12oz

OZ-5803-23

- Medium head size 35mm Ø
- Weight 550g/20oz

OZ-5804-23



- Large head size 40mm Ø
- Weight 700g/25oz

OZ-5805-23



OZ-Ilets

London Splint OZ-Ilet

- | 18cm/7" length
- | Head size 30mm Ø
- | Weight 450g/16.2oz

OZ-5802-18



Ombredanne OZ-Ilet

- 24cm/9½" length
- Head size 40mm Ø
- Weight 550g/20oz

OZ-5806-24



OZ-Ilet with Tufnol Handle

- 24cm/9½" length
- Lead filled head
- Weight 400g/14oz

OZ-5810-24



Tufnol OZ-Ilet

- | 25.5cm/10" length
- | Head size 42mm Ø
- | Weight 250g/10oz

OZ-5807-25





Osteotomes

Mini-Lambotte Osteotome

12.5cm/5" length



Width

OZ-5270-02	2mm
OZ-5270-03	3mm
OZ-5270-04	4mm
OZ-5270-06	6mm
OZ-5270-08	8mm

Set of 5 sizes:
2mm to 8mm

OZ-5270-28

Lambotte Osteotome

25cm/9¾" length



Straight Width

OZ-7970-04	4mm
OZ-7970-06	6mm
OZ-7970-08	8mm
OZ-7970-10	10mm
OZ-7970-13	13mm
OZ-7970-15	15mm
OZ-7970-18	18mm
OZ-7970-20	20mm
OZ-7970-25	25mm
OZ-7970-30	30mm

Curved Width

OZ-7971-04	4mm
OZ-7971-06	6mm
OZ-7971-08	8mm
OZ-7971-10	10mm
OZ-7971-13	13mm
OZ-7971-15	15mm
OZ-7971-18	18mm
OZ-7971-20	20mm
OZ-7971-25	25mm
OZ-7971-30	30mm

Ultra Fine Osteotome (Titanium Nitrate Coated)

16cm/6¼" length



Width

OZ-5230-02	2mm
OZ-5230-04	4mm
OZ-5230-06	6mm
OZ-5230-08	8mm
OZ-5230-10	10mm
OZ-5230-12	12mm

Set of 6 sizes: 2mm to 12mm complete with OZ-11et in sterilising case

OZ-5230-48

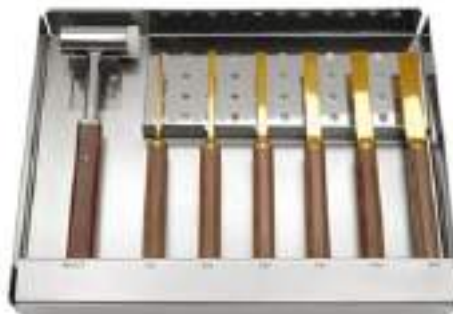



Osteotomes

Mini-Stillle Osteotome

l 16cm/6¼" length

Straight Width

OZ-7704-16	4mm
OZ-7706-16	6mm
OZ-7708-16	8mm



Stillle (Swedish) Osteotome

• 20cm/8" length

Straight Width

OZ-7706-20	6mm
OZ-7708-20	8mm
OZ-7710-20	10mm
OZ-7712-20	12mm
OZ-7715-20	15mm
OZ-7720-20	20mm
OZ-7725-20	25mm
OZ-7730-20	30mm



Hibbs Osteotome with thin blade

- 20cm/8" length
- Extra thin blade

Straight Width

OZ-7804-20	4mm
OZ-7806-20	6mm
OZ-7808-20	8mm
OZ-7810-20	10mm
OZ-7812-20	12mm
OZ-7815-20	15mm
OZ-7820-20	20mm
OZ-7825-20	25mm
OZ-7830-20	30mm

Curved Width

OZ-7904-20	4mm
OZ-7906-20	6mm
OZ-7908-20	8mm
OZ-7910-20	10mm
OZ-7912-20	12mm
OZ-7915-20	15mm
OZ-7920-20	20mm
OZ-7925-20	25mm
OZ-7930-20	30mm



Smith Petersen Osteotome

• 20cm/8" length

Width

OZ-7610-20	10mm
OZ-7615-20	15mm
OZ-7620-20	20mm
OZ-7625-20	25mm
OZ-7630-20	30mm



Osteotomes

Mini-Lexer Osteotome

- | 18cm/7" length
- Tufnol handle

OZ-5250-48 Set of 5 sizes:
2mm to 10mm

	Width
OZ-5250-02	2mm
OZ-5250-04	4mm
OZ-5250-06	6mm
OZ-5250-08	8mm
OZ-5250-10	10mm



Lexer Osteotome

- 22cm/8½" length
- Tufnol handle

	Width
OZ-7207-22	7mm
OZ-7210-22	10mm
OZ-7215-22	15mm
OZ-7220-22	20mm
OZ-7225-22	25mm



Dahmen Osteotome

- 30cm/12" length
- Tufnol handle

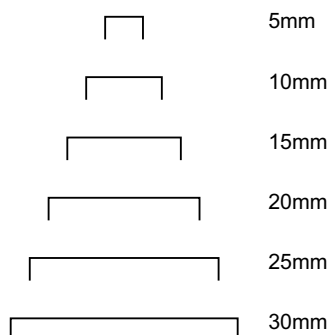

Straight Width

OZ-7105-30	5mm
OZ-7110-30	10mm
OZ-7115-30	15mm
OZ-7120-30	20mm
OZ-7125-30	25mm
OZ-7130-30	30mm

Angled Width

OZ-7305-30	5mm
OZ-7310-30	10mm
OZ-7315-30	15mm
OZ-7320-30	20mm
OZ-7325-30	25mm
OZ-7330-30	30mm



Osteotomes & Gouges

Box Chisel

- | 29cm/13½" length
- | For preparation of the proxiOZ-I femur
- | 31mm width x 6mm

OZ-7031-29



Pelvic Osteotome

- 30cm/12" length
- Tufnol handle
- Angled shaft

15mm width

20mm width

OZ-7015-30

OZ-7020-30



Chisel with Interchangeable Blades

- 20cm/8" length
- Tufnol handle
- Very thin blades

OZ-0790-20

Complete set with 4 blades* & key



Blade Width
5mm*

OZ-0792-05

OZ-0793-08

OZ-0793-10

OZ-0793-12

OZ-0794-15

OZ-0795-25

8mm

10mm*

12mm

15mm*

25mm*

Capener Lamina Gouge

- 23cm/9" length
- Cranked shaft

Width

OZ-6506-23

OZ-6508-23

OZ-6511-23

OZ-6516-23

6mm

8mm

11mm

16mm



Bone Curettes

- VolkOZ-nn Curette**
- 22cm/8¾" length
 - Double ended

Size

OZ-8401-22	SOZ-II
OZ-8402-22	Medium
OZ-8403-22	Large

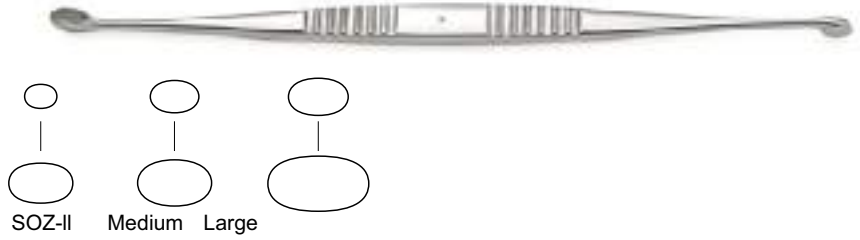

Muller Bone Curette

- 27cm/9¾" length
- Tufnol handle

*illustrated



Toothed Bone Curette

- 27cm/9¾" length
- Sharp spoon with teeth
- Tufnol handle

*illustrated

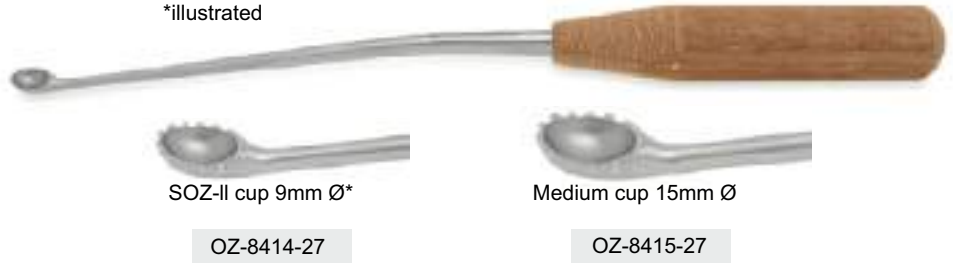

Charnley Bone Curette

- 37cm/15" length
- T-handle

*illustrated



Charnley Ring Curette

- 37cm/15" length
- Double sided
- Serrated cutting edge
- T-handle





Hip Revision Instruments

Cup Extraction Chisel

- 32cm/12½" length
- Curved 7mm tip
- Metal strike plate
- Tufnol handle



OZ-6507-32

Bayonet Gouge

- 32cm/12½" length
- Metal strike plate
- Tufnol handle
- 8mm width



OZ-6508-32

Swan Necked Gouge

- 28.5cm/11" length
- 25mm width



OZ-6525-28

Cement Gouge

- 34.5cm/13½" length



9mm width

OZ-6509-34

11mm width

OZ-6511-34

Cement Chisel Angled 15°

- 35.5cm/14 length
- 9mm tip



OZ-6109-35



Hip Revision Instruments

Cement Osteotome •
30cm/12" length

- Tufnol handle with strike plate

Width

OZ-6105- 30	5mm
OZ-6107- 30	7mm
OZ-6110-30	10mm



Cement Splitting Osteotome

- 30cm/12" length
- Tufnol handle with strike plate
- Guarded blade

Width

OZ-6205-30	5mm
OZ-6210-30	10mm



Straight Cement Gouge

- 30cm/12" length
- Tufnol handle with strike plate

Width

OZ-6305-30	5mm
OZ-6307-30	7mm
OZ-6310-30	10mm



Bayonet Cement Rasp

- 52cm/20½" length
- Tufnol handle

*illustrated



V-shape

OZ-6100-52



Strong round shape*

OZ-6101-52



Flat round curve

OZ-6102-52



Hip Revision Instruments

Bayonet Cement Chisel

- 40cm/15¾"length
- Tufnol handle with strike plate



Width

OZ-6105-40	5mm
OZ-6107-40	7mm
OZ-6110-40	10mm

Bayonet Cement Splitting Osteotome

- 40cm/15¾"length
- Tufnol handle with strike plate
- Guarded blade



Width

OZ-6205-40	5mm
OZ-6207-40	7mm
OZ-6210-40	10mm

Bayonet Cement Gouge

- 40cm/15¾"length
- Tufnol handle with strike plate



Width

OZ-6505-40	5mm
OZ-6507-40	7mm
OZ-6510-40	10mm

Bayonet Cement Gouge

- 40cm/15¾"length
- Tufnol handle with strike plate



Width

OZ-6605-40	5mm
OZ-6607-40	7mm
OZ-6610-40	10mm

For cement removal through fenestration in the femur.

Hip Revision Instruments

OZ-Ileable Cement Probe

- 38cm/15" length
- For probing the Femur

OZ-6900-38



Cement Plug Extractor

- 48cm/19" length
- T-handle
- For extraction of cement plug

OZ-6807-48

OZ-6809-48

OZ-6811-48

Thread Dia.
7mm

9mm

11mm



Used with a slotted OZ-Ilet



Retrograde Cement Chisel

- 50cm/19¾" length
- Tufnol T-handle
- Striking plate

OZ-6805-50

OZ-6807-50

OZ-6810-50

Width

5mm

7mm

10mm



Slotted OZ-Ilet

OZ-6850-00



Cement Extraction Hook

- 34.5cm/14" length

OZ-6905-34



3mm tip

Cement Twist Drill Long

- 40cm/15¾" length



Diameter

OZ-1400-06	6mm
OZ-1400-08	8mm
OZ-1400-10	10mm

Fine Cement Duckbill Grasping Forceps

- 35cm/14" shaft length
- Fine jaws



OZ-6901-35

Heavy Cement Grasping Forceps

- 26cm/10" shaft length
- Serrated jaws 6mm width



OZ-6902-26

Hip Revision Instruments

Femoral Head Extractor

- 23cm/9" length
- Tufnol handle

OZ-6916-23



Moore Femoral Head Extractor

- 20.5cm/8" length
- Metal handle

OZ-6914-20



Joint Capsule Clamp

- 21cm/8¼" length
- 25mm jaw length

OZ-6995-21



Joint Capsule Scissors

- 25cm/9¾" length
- Angled blades

OZ-6910-25





OZZE MEDICAL & SURGICAL SUPPLIES
TOOLS TO OPERATE

Hip Joint Instruments

Femoral Head Impactor

- 20cm/8" length
- Nylon head

OZ-6918-20



McGoey Bone Punch

- Double ended



* illustrated

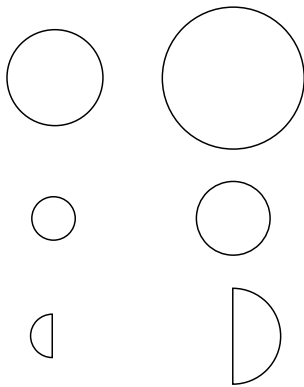

No 1. 13mm x 19mm Ø

OZ-6913-19

Large size

No 2. 6mm x 10mm Ø

OZ-6906-10

*SOZ-II size

No 3. 6mm x 13mm Ø
With flats

OZ-6906-13

Hardinge Cement Restrictor

- 33.5cm/13¾" length
- Graduated shaft

OZ-6920-33



Femoral Pusher

- Square ended

OZ-6925-20





Pliers & Wire Cutters

Universal Fine Pliers and Cutters

- 15cm/6" length

OZ-7640-15

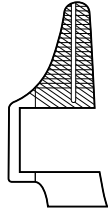

Slim & Square Ended Wire Pliers

- 19cm/7½" length

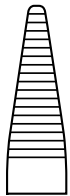

Slim Nose

OZ-7645-19
Serrated jaw



Square Ended*

OZ-7644-19



*illustrated

Pliers for Screw Removal

- 20cm/8" length

OZ-5701-20



Muller Claus Wire Pullers

- 18cm/7" length
- Double action
- Tungsten jaws

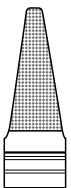

2mm Jaws
OZ-8-818E18

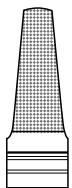

4mm Jaws
OZ-8-820E18



6mm Jaws
OZ-8-821E18



Pliers & Wire Cutters

Muller Claus Wire Cutters

- 16cm/6" length
- Tungsten carbide edges
- Cuts wire up to 1.6mm Ø

OZ-8-810E16



Muller Claus Wire Cutters

- Tungsten carbide edges

OZ-8-810E18

- 18cm/7" length*
- Cuts wire up to 2mm Ø

OZ-8-800E22

- 22cm/8¾" length
- Cuts wire up to 3mm Ø



*illustrated

End Wire Cutters

- 18cm/7" length
- Tungsten carbide edges
- Cuts wire up to 1.7mm Ø

OZ-8-816E18



Bolt Cutters with disOZ-ntable arms

- OZ-x. cap 6.3mm pins

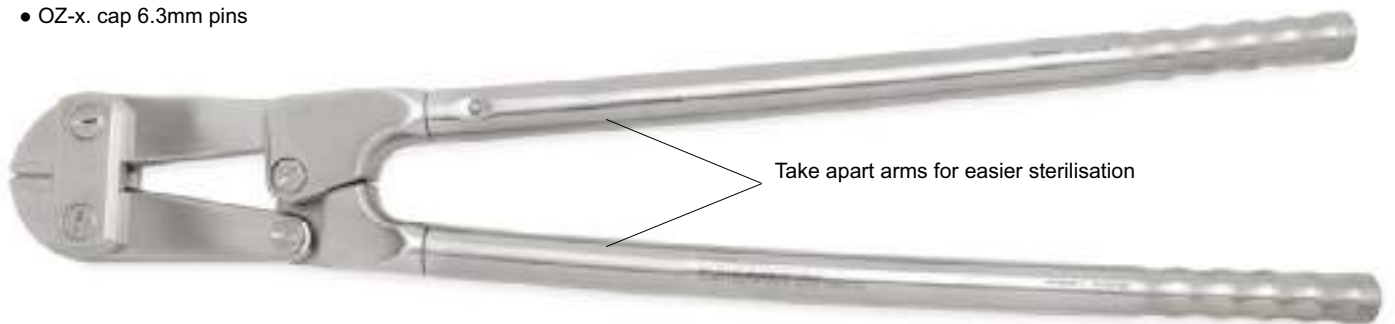

OZ-200-500-585

- Must be used in conjunction with a Rod Holder. Ordering Code: 200-675-200

Wire Cutters

Combined Wire Cutters & Pliers

- 18cm/7" length
- Suitable for wires up to 1.6mm Ø
- Parallel closing jaws

OZ-200-512-185



Wire Cutters with T/C Jaws

- 24cm/9½" length
- Double action
- Cuts plates & wires up to 2.7mm Ø

OZ-7644-24



'Power Cut' Wire Cutters

- 20cm/8" length
- Cutting inserts are T/C and can be replaced
- Cuts wires up to 3mm Ø

OZ-7645-20





Locking Pliers

Needle Nosed Locking Pliers



Code	Length	200-514-220
	22cm/8¾"	S
OZ-200-515-250	25cm/9¾"	Medium
OZ-200-516-300	30cm/11¾"	Large

• A very useful instrument for orthopaedic surgery allowing the surgeon to securely clamp on to wires and implants.

Pliers modified for Slap Hammer

Code	Length	200-514-221
	22cm/8¾"	S
OZ-200-515-251	25cm/9¾"	Medium
OZ-200-516-301	30cm/11¾"	Large

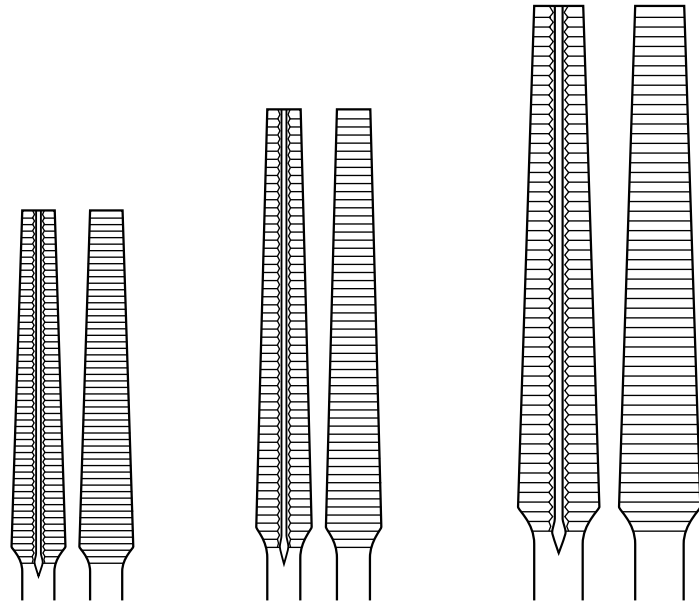

22cm/8¾" SOZ-II 25cm/9¾" Medium 30cm/11¾" Large

Slap Hammer attachment only

Code Length Weight

OZ-210-400-350	35cm/13¾"	400g*
OZ-210-700-350	40cm/15¾"	700g+

*Fits pliers - sOZ-II & medium size
+Fits pliers - large size

N.B. When used with slap hammer the locking pliers need modification.



Orthopaedic Locking Pliers

- Hardened jaws

Code	Length	200-511-180
	18cm/7"	S
OZ-200-511-200	20cm/8"	Medium
OZ-200-511-240	24cm/9½"	Large



Orthopaedic Locking Pliers modified for Slap Hammer

Code	Length	200-511-181
	18cm/7"	S
OZ-200-511-201	20cm/8"	Medium
OZ-200-511-241	24cm/9½"	Large

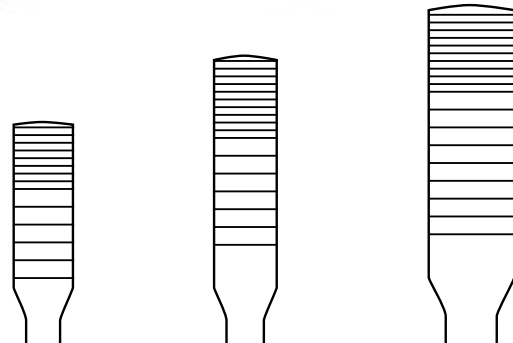

18cm/7" SOZ-II 20cm/8" Medium 24cm/9½" Large

N.B. When used with slap hammer the locking pliers need modification.

Pin Introducers

Kirschner Wire Introducing T-Handle

- 12cm/4¾" length
- 1.5mm Ø wires

OZ-5015-12



SteinOZ-nn Pin Introducer T-Handle

- 14cm/5½" length
- 0.5mm - 8mm Ø pins
- With Jacobs chuck & key

OZ-5502-14



SteinOZ-nn Pin Introducer T-Handle

- 14cm/5½" length
- 0.7mm - 6mm Ø pins
- Universal chuck

OZ-5507-14





Misc

Bone Mill

- Table mounted with crank handle
- With removable cutting drum*

OZ-6001-00

For grinding bone chips used for bone graft procedures.



Cutting Drum Sizes
3mm Ø hole bore

*
4mm Ø hole bore
5mm Ø hole bore

Wire Passing Guide

- 21cm/8¼" length



Used for passing wire around bones.

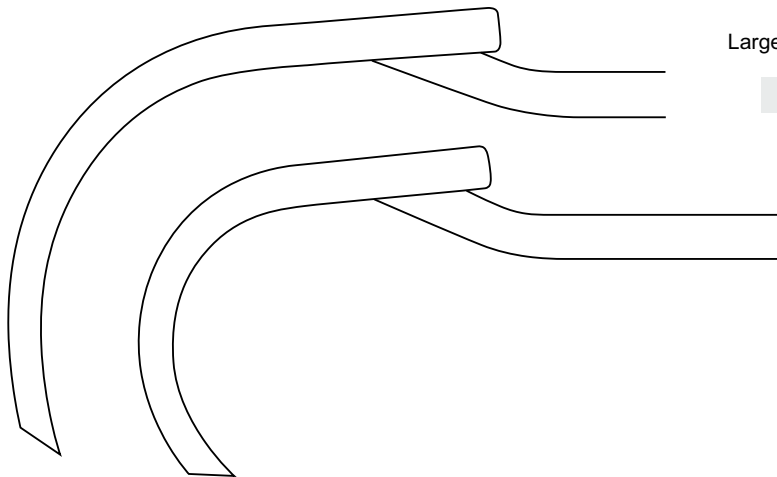

Large curve 70mm Ø

OZ-6105-21

SOZ-II curve 45mm Ø

OZ-6104-21

Bone Awl

- Straight with eye

	Diameter	Length
OZ-5602-12	2.0mm	125mm
OZ-5602-13	2.4mm	130mm
OZ-5602-14	2.8mm	145mm
OZ-5602-15	3.2mm	160mm
OZ-5602-16	3.6mm	165mm
OZ-5602-17	4.0mm	175mm



Screwdrivers

Slotted Head

- 17cm/6¾" length
- For head screws 2.7mm - 4.0mm

OZ-7014-17



Long Slotted Head

- 25cm/10" length
- For head screws 2.7mm - 4.0mm

OZ-7014-25



Phillips Head •

- 25cm/10" length
- For sOZ-II Phillips head screws 6mm

OZ-7015-25



Cross Slotted Head

- 25cm/10" length
- For cross slot screws 6mm

OZ-7016-25



Screwdrivers

Hexagonal Head

- 25cm/10" length
- For hexagonal head screws 2.7mm - 4.0mm



2.5mm Hex

OZ-7017-25

For 2.7mm to 3.5mm screws



3.5mm Hex

OZ-7018-25

For 4.5mm to 6.5mm screws

Screwdriver Handle

- To fit shafts with quick lock attachment

OZ-7020-02



Screwdriver Handle Small

- To fit shafts with quick lock attachment

OZ-7020-01



Shaft with Quick Lock Fitting

- Hexagonal tip



Shaft Diameter OZ-7021-00

OZ-7022-00

2.5mm

3.5mm

Dissectors

- Howarth Elevator
• 21.5cm/8½" length



OZ09207-21

MacDonald Elevator/Dissector



	Size
OZ-7105-19	19cm/7½"
OZ-9206-23	23cm/9"

Watson Cheyne Dissector



	Length
OZ-7203-18	18cm/7"
OZ-9203-23	23cm/9"
OZ-9203-25	25.5cm/10"

Freers Elevator/Dissector

- 18.5cm/7¼" length



OZ-7602-18

Swedish Dissector

- 18cm/7" length



OZ-9201-18

Stainless Steel Measuring Ruler

Code Length

OZ-5005-15	15cm/6"
OZ-5005-30	30cm/12"



Measuring Caliper

- 25cm/10" length
- Measuring range 0-50mm

OZ-7334-20



Vernier Caliper

- 22.5cm/9" length
- Measuring range 15cm

OZ-7338-00



Depth Gauge

- Measuring depth up to 50mm
- Hook part of probe: Ø1.7mm
- Measuring probe (bottom): Ø1.6mm

OZ-7350-00



Depth Gauge

- Measuring depth up to 70mm

OZ-7370-00



Direct Reading Depth Gauge

- 23cm length
- Measuring depth up to 40mm

OZ-7333-10



Arthroscopy Punches

Slimline Basket Punch
• Narrow compact jaw design



Slimline Basket Punch



	Jaws	Width
OZ-225-800-002	Straight	1.7mm
OZ-225-800-005	Up biter	1.7mm
OZ-225-800-011	Up curved shaft	1.7mm



Straight Tip & Shaft



Upwards Angled Tip



Upwards Angled Shaft

Regular Basket Punch



Basket Punch



	Jaws	Width
OZ-225-800-050	Straight	3.4mm
OZ-225-800-055	Up biter	1.5mm



Straight Tip & Shaft



Upwards Angled Tip



Arthroscopy Punches

Duckbill Basket Punch

- Multi purpose low profile punch with square bite



Duckbill Basket Punch



Profile Duckbill jaws

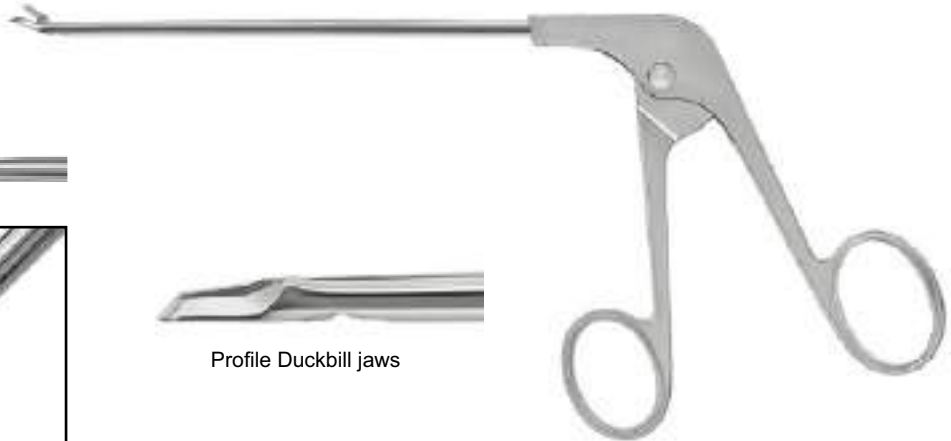

	Jaws	Width
OZ-225-800-102	Straight	3.2mm
OZ-225-800-105	Up biter	3.2mm
OZ-225-800-107	Up biter left	3.2mm
OZ-225-800-109	Up biter right	3.2mm



Straight Tip & Shaft



Upwards Angled Tip



Curved in Shaft

Duckling Basket Punch



Duckling Basket Punch



Low profile duckling jaws

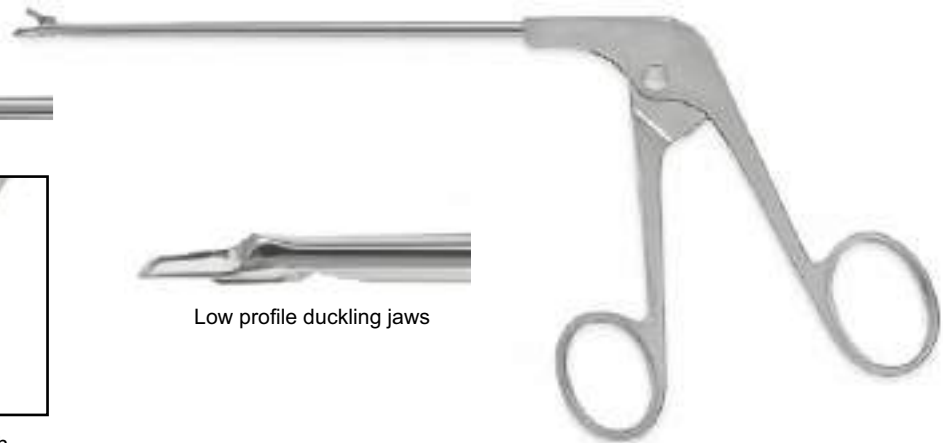

	Jaws	Width
OZ-225-800-402	Straight	3.2mm
OZ-225-800-405	Up biter	3.2mm
OZ-225-800-411	Up curved shaft	3.2mm
OZ-225-800-413	Left curved shaft	3.2mm
OZ-225-800-415	Right curved shaft	3.2mm



Straight Tip & Shaft



Upwards Angled Tip



Upwards Angled Shaft





Curved in Shaft

Arthroscopy Punches

Scissor Punch
• Extremely slim jaws



Scissor Punch

Jaws	Width		
OZ-225-800-532	Straight	1mm	 Straight Tip & Shaft
OZ-225-800-535	Up biter in jaw	1mm	 Upwards Angled Tip

Biopsy Rongeur

• Cupped jaw design



Biopsy Rongeur Forceps

OZ-225-800-920



Arthroscopy Punches

Hook Scissors



Hook Scissors straight

OZ-225-800-472

Oval Punch

- Low profile large oval bite



Oval Punch straight

	Jaws	Width
OZ-225-800-202	Straight	4.4mm
OZ-225-800-205	Up biter	4.4mm
OZ-225-800-211	Up curved shaft	4.4mm
OZ-225-800-213	Left curved shaft	4.4mm
OZ-225-800-215	Right curved shaft	4.4mm

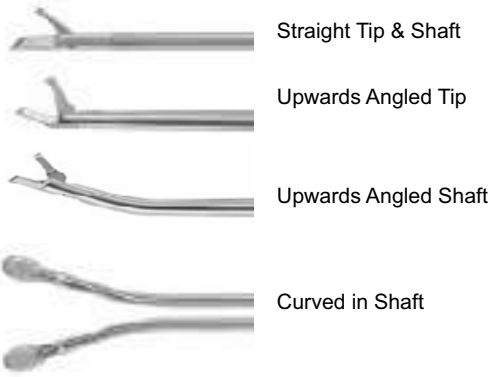

Arthroscopy Punches

Back Biter Punches



Left cutting
Straight shaft

OZ-225-800-707

Right cutting
Straight shaft

OZ-225-800-709

Scoop Basket Punch

- Short blunt nose



Scoop Basket Punch

Jaws	Width	
OZ-225-800-802	Straight	1mm
OZ-225-800-813	Shaft curved left	1.3mm
OZ-225-800-815	Shaft curved right	1.3mm

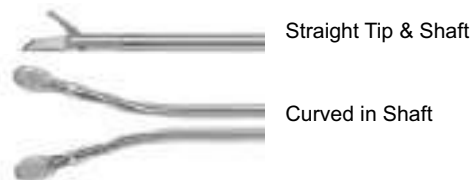



Arthroscopy Grasping Forceps

Grasping Forceps

- With slide lock



Shark Grasping Forceps

OZ-225-800-820

1x2 interlocking teeth



Alligator Grasping Forceps

OZ-225-800-825

Multiple bacMAard teeth



Cupped Grasper

OZ-225-800-833

Cupped serrated jaw 3.3mm



Heavy Alligator Grasping Forceps

OZ-225-800-835

Larger jaw with multiple teeth



Plastic Sterilising Container

- For 8 Arthroscopy instruments

OZ-600-513-000



Micro Fracture Chondro-Picks

Mercian offers a complete set of Micro Fracture Chondro-Picks for treatment of cartilage defects on large and medium joints.

- All instruments feature an ergonomic carbon fibre handle with impact protection for use with the specially designed mallet.
- 5 different tip angles give the surgeon full flexibility in Micro Fracture surgery.
- Hardened stainless steel ensures a long life-time of each Pick.

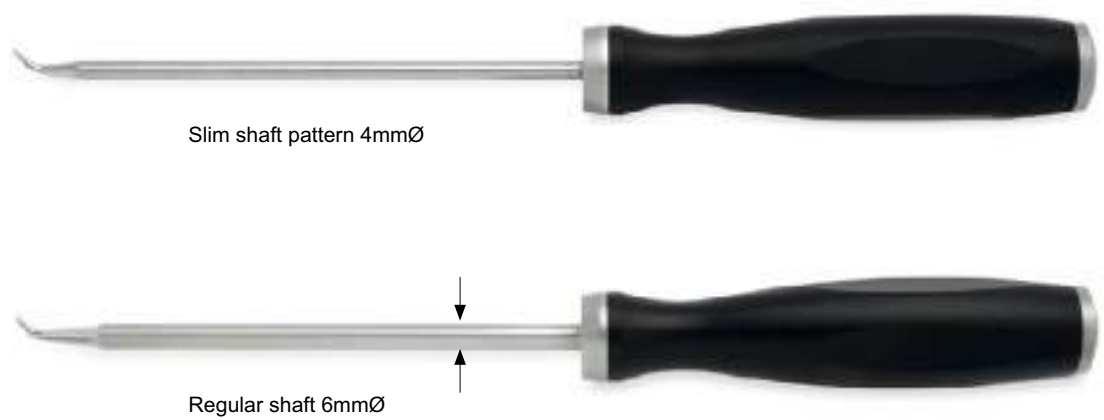

	Slim Shaft 4mmØ	Shaft 6mmØ
	Chondro-Pick Straight OZ-225-600-200S	Chondro-Pick Straight OZ-225-600-200
	Chondro-Pick 25° OZ-225-600-225S	Chondro-Pick 25° OZ-225-600-225
	Chondro-Pick 40° OZ-225-600-240S	Chondro-Pick 40° OZ-225-600-240
	Chondro-Pick 60° OZ-225-600-260S	Chondro-Pick 60° OZ-225-600-260
	Chondro-Pick 90° OZ-225-600-290S	Chondro-Pick 90° OZ-225-600-290

Arthroscopic Blunt Hook

- 24cm/10" length
- Graduated tip



2.5mm tip

OZ-225-400-002



3.5mm tip

OZ-225-400-004

Hook Probe

- 24cm/10" length
- Graduated tip
- 2.5mm tip



OZ-225-600-004

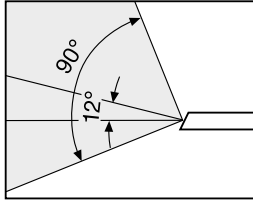

30°



Stryker Compatible Arthroscope 4mm Ø

- 140mm working length
- 30° angle of view

OZ-225-740-030



High Flow Operating Sheath 6mm Ø

- Stryker locking mechanism
- 2 rotating stopcocks

OZ-225-570-260



Blunt Obturator 6mm Ø

OZ-225-570-560



Semi-Sharp Obturator 6mm Ø

OZ-225-570-760



Dyonics™ Compatible

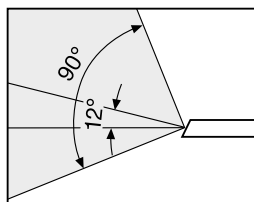

30°



Dyonics Compatible Arthroscope 4mm Ø

- 155mm working length
- 30° angle of view

OZ-225-440-030



High Flow Operating Sheath 6mm Ø

- Stryker locking mechanism
- 2 rotating stopcocks

OZ-225-540-260



Blunt Obturator 6mm Ø

OZ-225-540-560



Sharp Obturator 6mm Ø

OZ-225-540-760



Regular Fitting

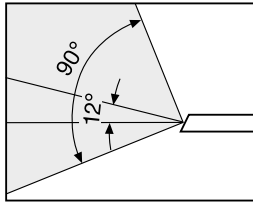

30°



OZ-225-140-030



High Flow Operating Sheath 6mm Ø

- 2 stopcocks

OZ-225-500-260



Blunt Obturator 6mm Ø

OZ-225-500-560



Sharp Obturator 6mm Ø

OZ-225-500-660



Fibre Optic Light Lead

Code	Length	Diameter
OZ-250-035-180	1800mm	3.5mm Ø
OZ-250-035-230	2300mm	3.5mm Ø
OZ-250-035-300	3000mm	3.5mm Ø
OZ-250-048-180	1800mm	4.8mm Ø
OZ-250-048-230	2300mm	4.8mm Ø
OZ-250-048-300	3000mm	4.8mm Ø



Adaptors for Light Lead

Lightsource Fittings



Wolf

OZ-250-037-000



ACMI British Standard

OZ-250-038-000



Olympus - Standard

OZ-250-045-000

Mercian/Storz

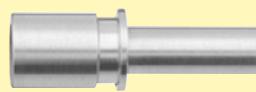

OZ-250-039-000



Olympus

OZ-250-044-000

Retractor Fitting



OZ-250-042-000

Twist Drills

Round Fitting Twist Drill

- Stainless steel
- Supplied sterile in boxes of 10

Code	Diameter	Length	Flute
OZ-1045-11	1.1mm Ø	45mm	20mm
OZ-1070-15	1.5mm Ø	70mm	30mm
OZ-1085-20	2.0mm Ø	85mm	38mm
OZ-1095-25	2.5mm Ø	95mm	43mm
OZ-1195-25	2.5mm Ø	195mm	50mm
OZ-1130-32	3.2mm Ø	130mm	40mm
OZ-1095-35	3.5mm Ø	95mm	42mm
OZ-1130-45	4.5mm Ø	130mm	55mm

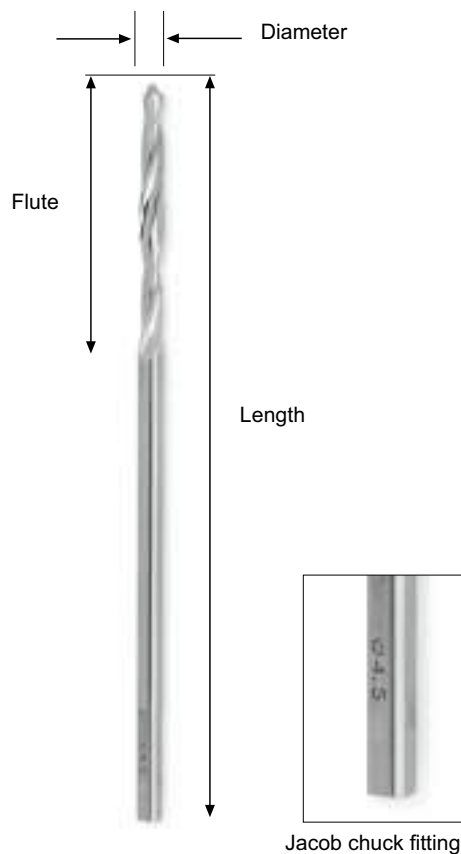

AO Fitting Twist Drill

- Stainless steel
- Supplied sterile in boxes of 10

Code	Diameter	Length	Flute
OZ-2060-11	1.1mm Ø	60mm	12mm
OZ-2085-15	1.5mm Ø	85mm	18mm
OZ-2100-20	2.0mm Ø	100mm	20mm
OZ-2110-20	2.0mm Ø	110mm	32mm
OZ-2110-25	2.5mm Ø	110mm	32mm
OZ-2110-25G	2.5mm Ø	110mm	32mm
OZ-2100-27	2.7mm Ø	100mm	30mm
OZ-2150-27	2.7mm Ø	150mm	50mm
OZ-2145-32	3.2mm Ø	145mm	43mm
OZ-2195-32	3.2mm Ø	195mm	50mm
OZ-2110-35	3.5mm Ø	110mm	40mm
OZ-2195-35	3.5mm Ø	195mm	50mm
OZ-2145-45	4.5mm Ø	145mm	50mm
OZ-2195-45	4.5mm Ø	195mm	50mm

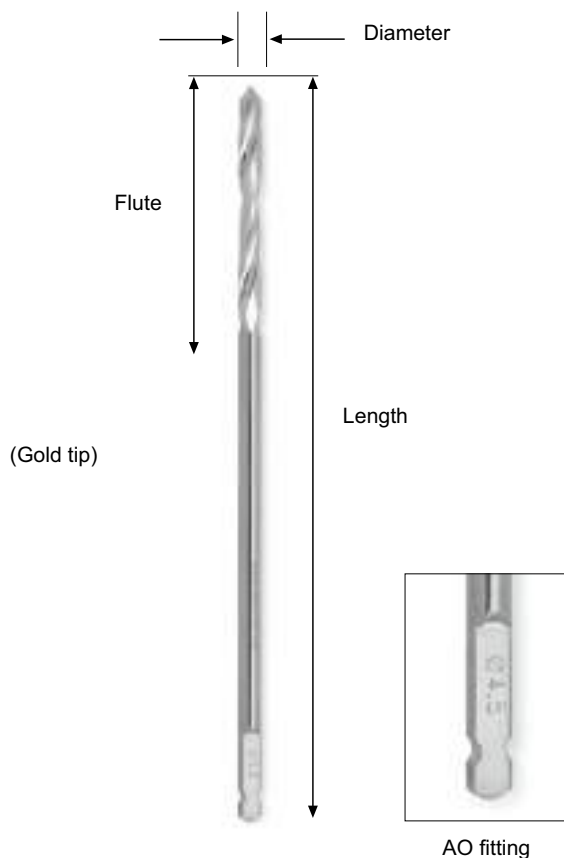

Kirschner Wires

- Stainless steel
- Supplied sterile in boxes of 10



Single Ended	75mm/3"	100mm/4"	125mm/5"	150mm/6"
Ø 0.8mm	OZ-6075 - 08	OZ-6100 - 08	OZ-6125 - 08	OZ-6150 - 08
Ø 0.9mm	OZ-6075 - 09	OZ-6100 - 09	OZ-6125 - 09	OZ-6150 - 09
Ø 1.0mm	OZ-6075 - 10	OZ-6100 - 10	OZ-6125 - 10	OZ-6150 - 10
Ø 1.1mm	OZ-6075 - 11	OZ-6100 - 11	OZ-6125 - 11	OZ-6150 - 11
Ø 1.2mm	OZ-6075 - 12	OZ-6100 - 12	OZ-6125 - 12	OZ-6150 - 12
Ø 1.3mm	OZ-6075 - 13	OZ-6100 - 13	OZ-6125 - 13	OZ-6150 - 13
Ø 1.4mm	OZ-6075 - 14	OZ-6100 - 14	OZ-6125 - 14	OZ-6150 - 14
Ø 1.5mm	OZ-6075 - 15	OZ-6100 - 15	OZ-6125 - 15	OZ-6150 - 15
Ø 1.6mm	OZ-6075 - 16	OZ-6100 - 16	OZ-6125 - 16	OZ-6150 - 16
Ø 1.7mm	OZ-6075 - 17	OZ-6100 - 17	OZ-6125 - 17	OZ-6150 - 17
Ø 1.8mm	OZ-6075 - 18	OZ-6100 - 18	OZ-6125 - 18	OZ-6150 - 18
Ø 1.9mm	OZ-6075 - 19	OZ-6100 - 19	OZ-6125 - 19	OZ-6150 - 19
Ø 2.0mm	OZ-6075 - 20	OZ-6100 - 20	OZ-6125 - 20	OZ-6150 - 20
Ø 2.2mm	OZ-6075 - 21	OZ-6100 - 21	OZ-6125 - 21	OZ-6150 - 21
Ø 2.5mm	OZ-6075 - 22	OZ-6100 - 22	OZ-6125 - 22	OZ-6150 - 22



Double Ended	75mm/3"	100mm/4"	125mm/5"	150mm/6"
Ø 0.8mm	OZ-7075 - 08	OZ-7100 - 08	OZ-7125 - 08	OZ-7150 - 08
Ø 0.9mm	OZ-7075 - 09	OZ-7100 - 09	OZ-7125 - 09	OZ-7150 - 09
Ø 1.0mm	OZ-7075 - 10	OZ-7100 - 10	OZ-7125 - 10	OZ-7150 - 10
Ø 1.1mm	OZ-7075 - 11	OZ-7100 - 11	OZ-7125 - 11	OZ-7150 - 11
Ø 1.2mm	OZ-7075 - 12	OZ-7100 - 12	OZ-7125 - 12	OZ-7150 - 12
Ø 1.3mm	OZ-7075 - 13	OZ-7100 - 13	OZ-7125 - 13	OZ-7150 - 13
Ø 1.4mm	OZ-7075 - 14	OZ-7100 - 14	OZ-7125 - 14	OZ-7150 - 14
Ø 1.5mm	OZ-7075 - 15	OZ-7100 - 15	OZ-7125 - 15	OZ-7150 - 15
Ø 1.6mm	OZ-7075 - 16	OZ-7100 - 16	OZ-7125 - 16	OZ-7150 - 16
Ø 1.7mm	OZ-7075 - 17	OZ-7100 - 17	OZ-7125 - 17	OZ-7150 - 17
Ø 1.8mm	OZ-7075 - 18	OZ-7100 - 18	OZ-7125 - 18	OZ-7150 - 18
Ø 1.9mm	OZ-7075 - 19	OZ-7100 - 19	OZ-7125 - 19	OZ-7150 - 19
Ø 2.0mm	OZ-7075 - 20	OZ-7100 - 20	OZ-7125 - 20	OZ-7150 - 20
Ø 2.2mm	OZ-7075 - 21	OZ-7100 - 21	OZ-7125 - 21	OZ-7150 - 21
Ø 2.5mm	OZ-7075 - 22	OZ-7100 - 22	OZ-7125 - 22	OZ-7150 - 22



Threaded Pins

SteinOZ-nn Threaded Pins

- Stainless steel
- Trocar point
- Fully threaded
- Supplied sterile in boxes of 10

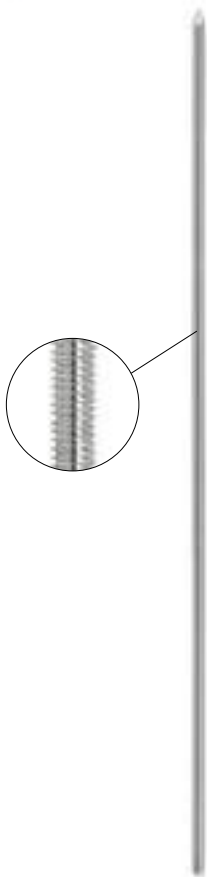

Single Ended	20cm/8"	23cm/9"
Ø 1.4mm	OZ-8200-14FT	OZ-8230-14FT
Ø 1.6mm	OZ-8200-16FT	OZ-8230-16FT
Ø 1.8mm	OZ-8200-18FT	OZ-8230-18FT
Ø 2.0mm	OZ-8200-20FT	OZ-8230-20FT
Ø 2.4mm	OZ-8200-24FT	OZ-8230-24FT
Ø 2.8mm	OZ-8200-28FT	OZ-8230-28FT
Ø 3.2mm	OZ-8200-32FT	OZ-8230-32FT

Double Ended	20cm/8"	23cm/9"
Ø 1.4mm	OZ-9200-14FT	OZ-9230-14FT
Ø 1.6mm	OZ-9200-16FT	OZ-9230-16FT
Ø 1.8mm	OZ-9200-18FT	OZ-9230-18FT
Ø 2.0mm	OZ-9200-20FT	OZ-9230-20FT
Ø 2.4mm	OZ-9200-24FT	OZ-9230-24FT
Ø 2.8mm	OZ-9200-28FT	OZ-9230-28FT
Ø 3.2mm	OZ-9200-32FT	OZ-9230-32FT

Denham Mid-Threaded Pins

- Stainless steel
- Trocar point/single ended
- Centrally threaded
- Supplied sterile in boxes of 5

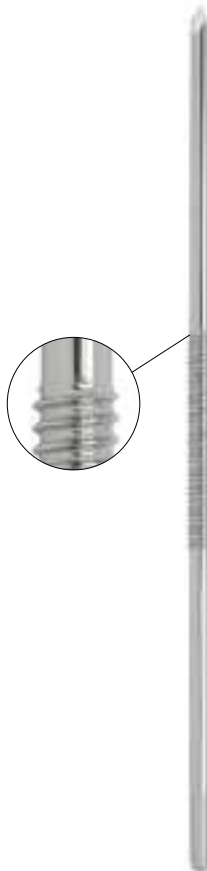

	18cm/7"	20cm/8"	23cm/9"
Ø 4.0mm	OZ-8180-40CT	OZ-8200-40CT	OZ-8230-40CT
Ø 4.5mm	OZ-8180-45CT	OZ-8200-45CT	OZ-8230-45CT
Ø 5.0mm	OZ-8180-50CT	OZ-8200-50CT	OZ-8230-50CT



OZZE MEDICAL & SURGICAL SUPPLIES
TOOLS TO OPERATE

SMO Steel Wire

SMO Steel Cerclage Wire

- Soft OZ-Ileable wire
- Supplied in coils of 10m



Wire Ø mm Ø
0.2mm

Length 10m

Ø 0.3mm
Ø 0.4mm
Ø 0.5mm
Ø 0.6mm
Ø 0.7mm
Ø 0.8mm
Ø 0.9mm
Ø 1.0mm
Ø 1.2mm
Ø 1.5mm

OZ-7600-02
OZ-7600-03
OZ-7600-04
OZ-7600-05
OZ-7600-06
OZ-7600-07
OZ-7600-08
OZ-7600-09
OZ-7600-10
OZ-7600-12
OZ-7600-15



©ZZE MEDICAL & SURGICAL SUPPLIES

TOOLS TO OPERATE



©ZZE MEDICAL & SURGICAL SUPPLIES

TOOLS TO OPERATE

FORTEEN

🖱 www.ozzesurgical.com.au

✉ info@ozzesurgical.com.au

Knochenklammern	Bone Clamps	SF 1
Knochenklammern	Bone Clamps	SF 2
Knochen Skids	Bone Skids	SF 3
Chirurgische Kompressoren	Surgical Compressors	SF 4
Chirurgische Küretten	Surgical Curettes	SF 5
Chirurgische Distraktoren	Surgical Distractors	SF 6
Chirurgische Aufzüge	Surgical Elevators	SF 7
Fixationsklemmen	Fixation Clamps	SF 8
Griffe	Handles	SF 9
Osteotome & Retraktoren Schmiedeteile	Osteotomes & Retractors Forgings	SF 10
Zangen Schmiede	Pliers Forgings	SF 11
Ringgriffklemmen	Ring Handle Clamps	SF 12-13
Kerrison Nagetierte	Rongeurs Kerrison	SF 14
Knochen nagetierte	Rongeurs Bone	SF 15
Scheren und Rod Benders	Scissors & Rod Bender	SF 16

Knochenklammern Bone Clamps

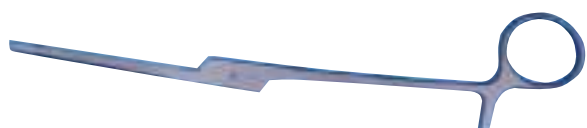
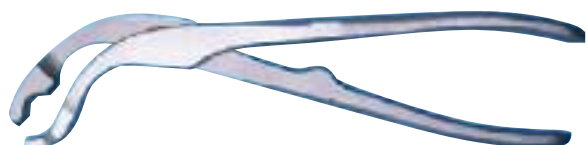
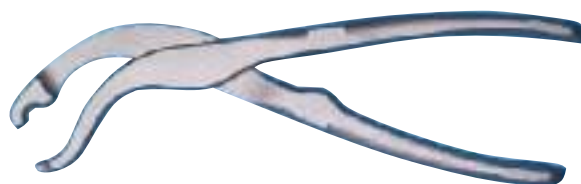



Knochenklammern
Bone Clamps

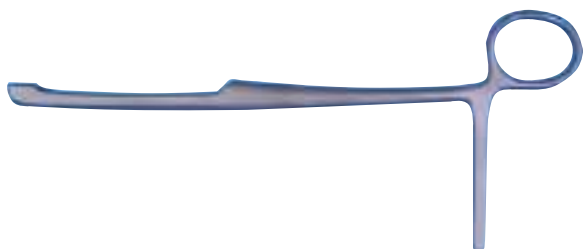
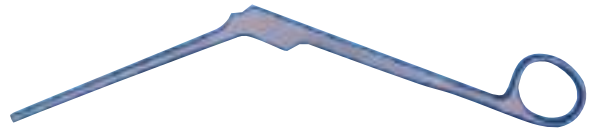
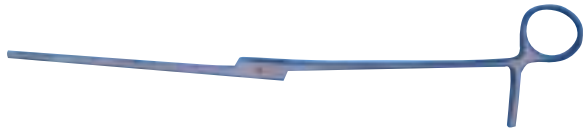

Knochen Skids
Bone Skids





Chirurgische Kompressoren
Surgical Compressors







Chirurgische Distraktoren
Surgical Distractors

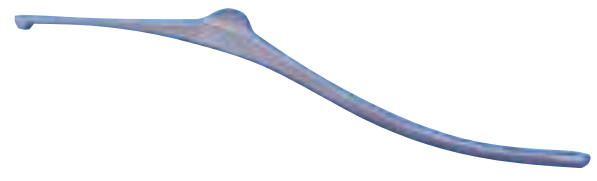
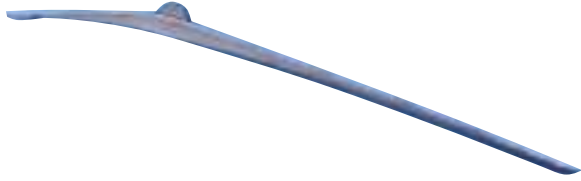
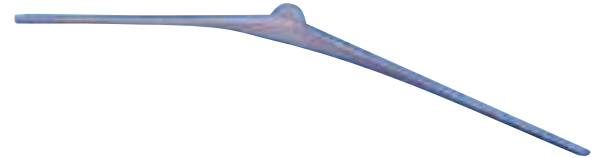
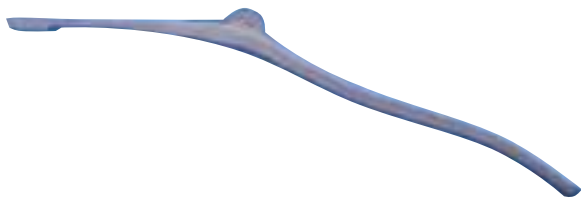



Fixationsklemmen
Fixation Clamps

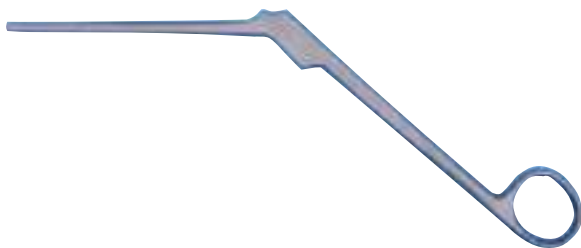
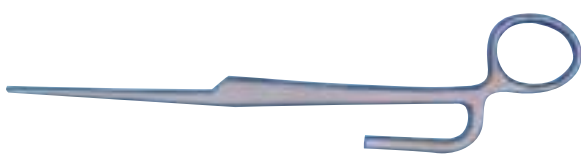
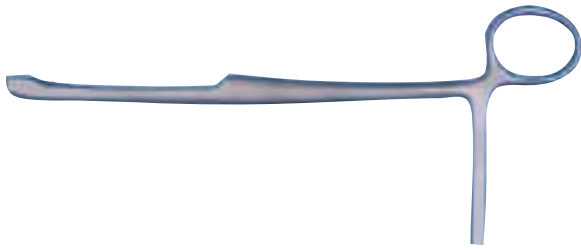



OZZE MEDICAL & SURGICAL SUPPLIES
TOOLS TO OPERATE

Griffe Handles

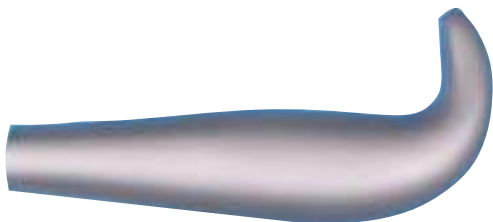
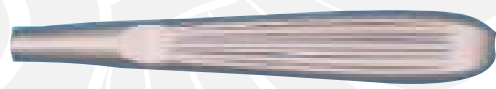
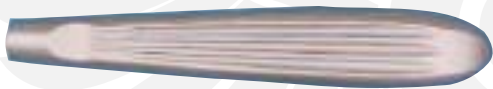
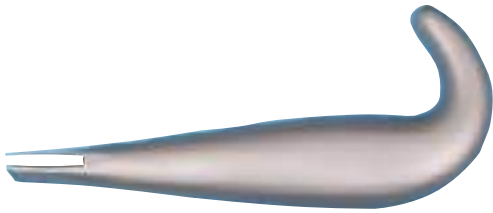
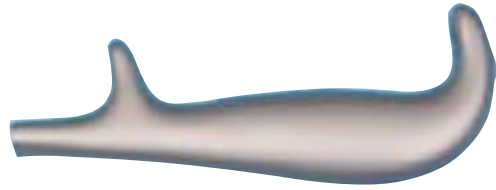



Osteotome & Retraktoren Schmiedeteile
Osteotomes & Retractors Forgings

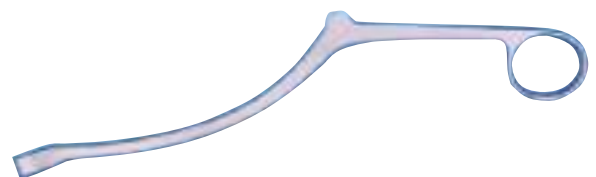
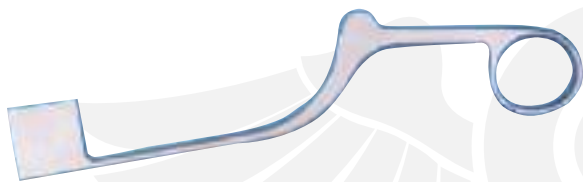
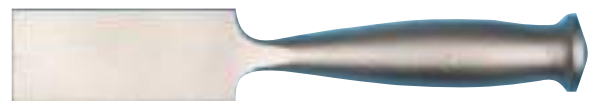

Zangen Schmiede
Pliers Forgings

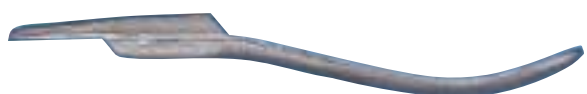



Ringgriffklemmen
Ring Handle Clamps

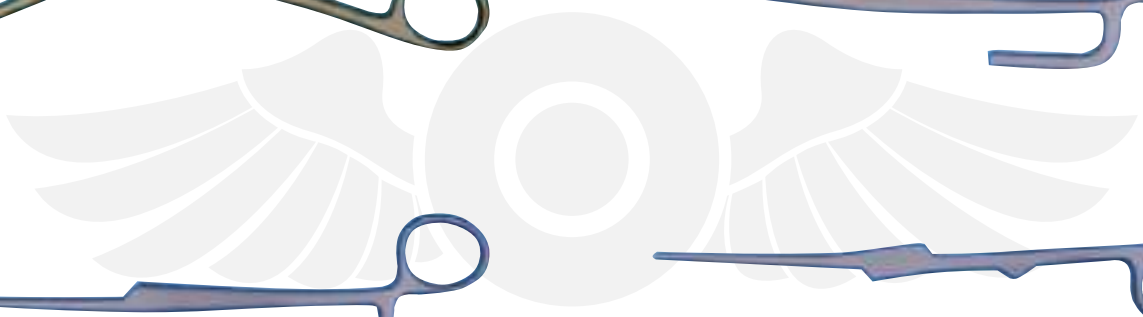
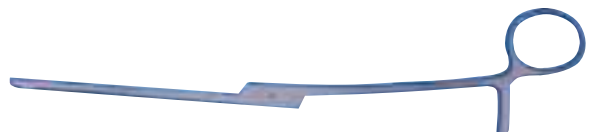
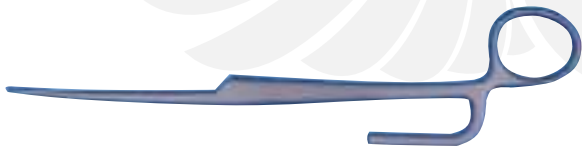
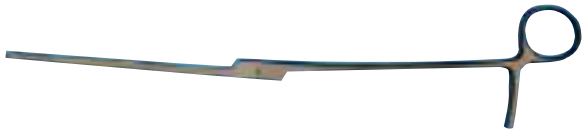



OZZE MEDICAL & SURGICAL SUPPLIES
TOOLS TO OPERATE

Ringgriffklemmen Ring Handle Clamps

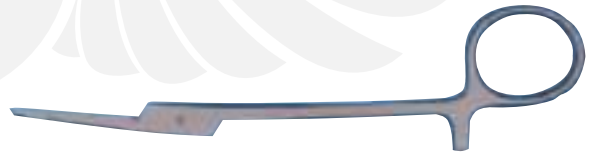
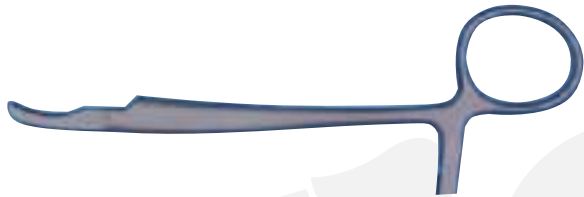
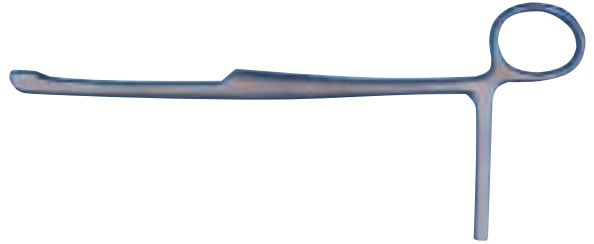



Kerrison Nagetiere
Rongeurs Kerrison

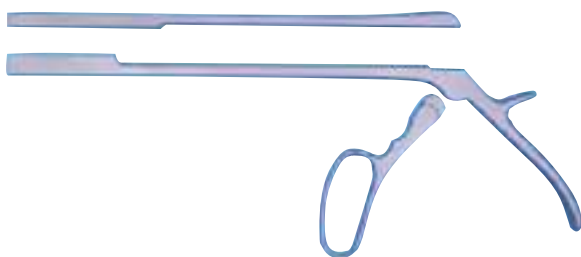
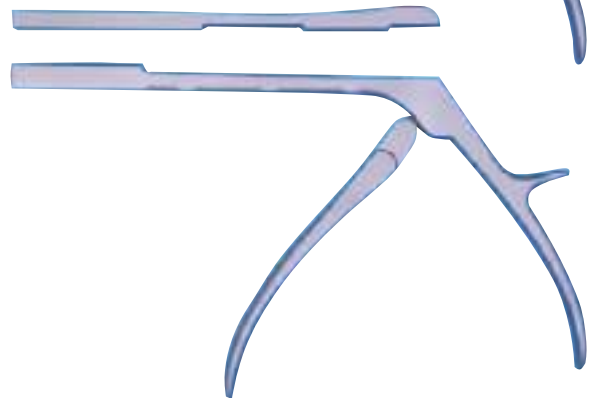
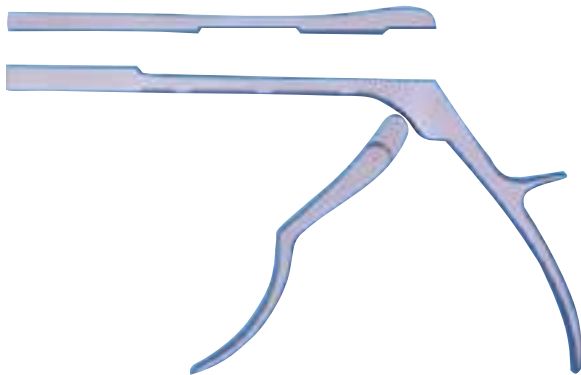
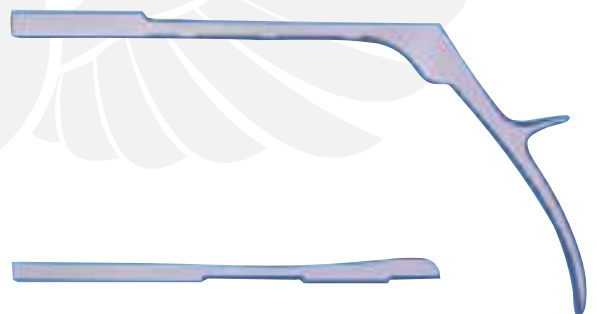
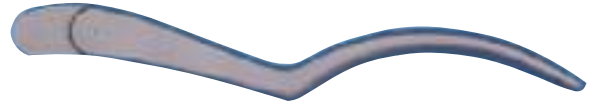



OZZE MEDICAL & SURGICAL SUPPLIES
TOOLS TO OPERATE

Knochenagetierte Rongeurs Bone

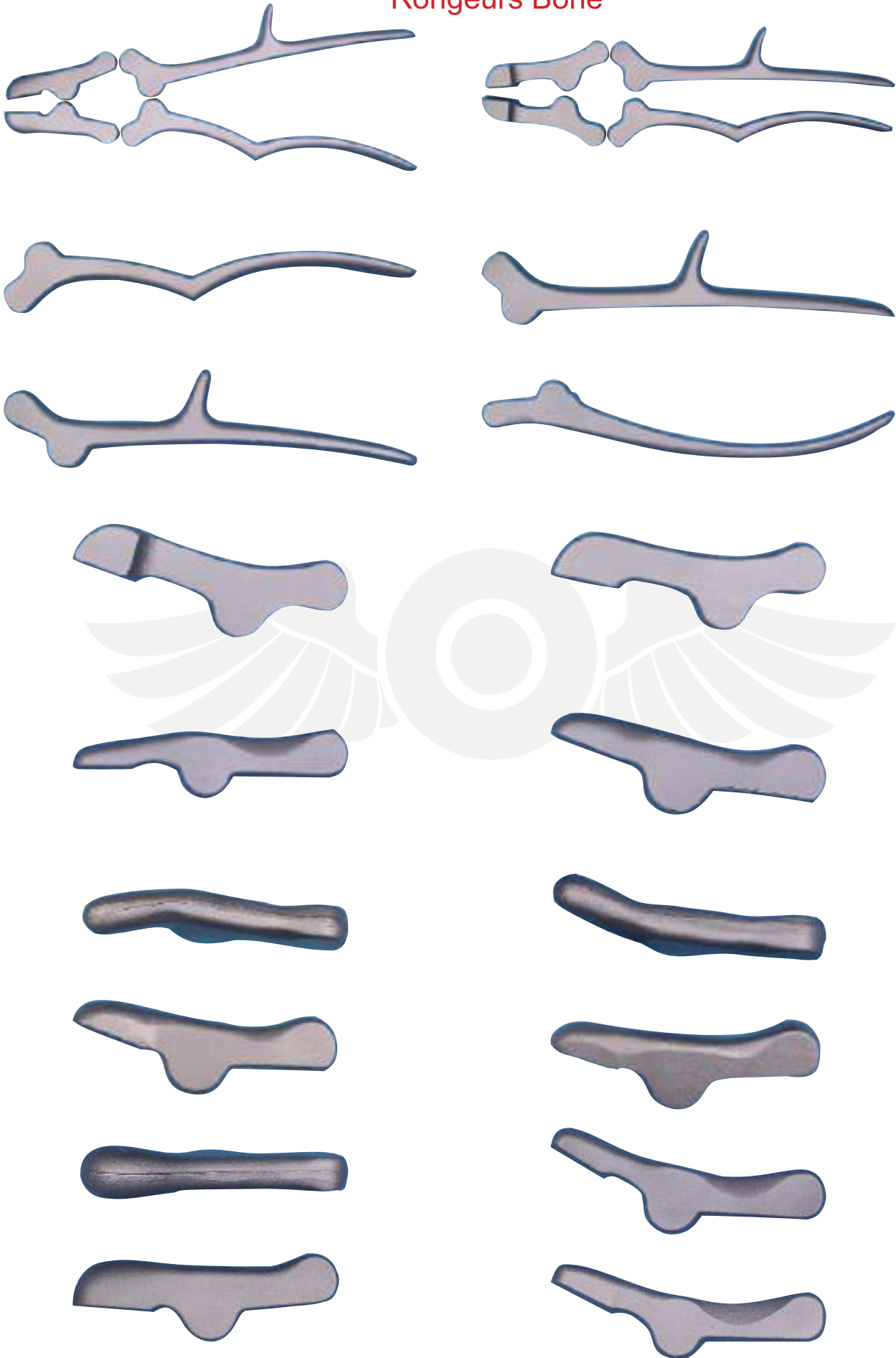



Scheren und Rod Benders
Scissors & Rod Benders

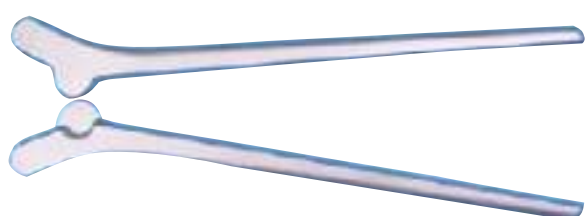

Face Mask



Disposable Facemask (50x) Per Box Non-medical
Item #: **OZ-FM-1001**
Daily Single Use, 3 Layers, Unisex



AirFlex Filtration Mask Pack
Material: 100% Other Fibres
Pack Quantity: Single Item
Item #: **OZ-FM-1003**



3M Aura 1870+ N95 Flat-fold
Surgical Disposable Respirator
Item #: **OZ-FM-1002**



Stethoscope

Stethoscope Chocolate Tube, Copper Finish (5809)

Standard 27 inch Tube

Fun and vibrant; match the color and finish to your personality!

Tunable, dual-sided stainless steel chestpiece with open or closed bell

Non-chill bell sleeve for greater patient comfort

Soft-sealing ear-tips provide optimal comfort and excellent sound occlusion



Item #: OZ-SC-1102



Item #: OZ-SC-1101





OZZE MEDICAL & SURGICAL SUPPLIES
TOOLS TO OPERATE



Layer Guard Cotton Stockinette Sleeve Roll,
Naturally Stretchable Raw Cotton
Comfort wear, Sweat Absorbent
Prevents Residue build up
Suitable for Under
Over Cast Bandage Wear (Off-White 3 Inch)
Material: Cotton
Item #: **OZ-GZ-1201**



Cotton Balls, Non-Sterile
For skin prepping, wound cleansing
The ideal general purpose swab
Item #: **OZ-GZ-1203**



Combine Roll 20cm x 10m
Gauze
Covered Roll
Item #: **OZ-GZ-1202**



Item #: **OZ-S-1301**

Stainless Steel, Dental Aspirating Syringe 1.8ML
Dental Syringe Dental Instruments Dental Syringe



Syringe Blunt Tip Needle and Cap - 10ml, 5ml, 3ml,
1ml Syringes 14ga 16ga 18ga 20ga
Blunt Needles - Oil or Glue Applicator



Item #: **OZ-S-1302**





©ZZE MEDICAL & SURGICAL SUPPLIES

TOOLS TO OPERATE

Australia's Leading Supplier of Medical & Surgical Instruments



©ZZE MEDICAL & SURGICAL SUPPLIES

TOOLS TO OPERATE

☎ 1800851334 | 03 6289 8973

✉ info@ozzesurgical.com.au

🖱 www.ozzesurgical.com.au

📍 205 Marys Hope Rd, Rosetta Tasmania 7010

